



















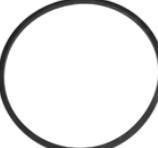
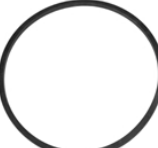
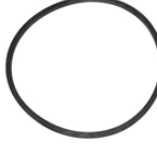

E. PRODUCT GUIDE

Service Parts

8265S	Used with LF516 Copper washer
105208S	Used with FF101 Gasket
116024S	Used with LF516 O'ring
	
132730SB	Bulk package (100) of 132730S.
142784S	Head used with FS1212, FF213, FF105C, FF105D, FF105, FF104, FS1000 Fuel filter head
	
145664SB	Bulk package (500) of 3301385S.
146990S	Air compressor housing assembly.
	
147669S	Housing used with AF251 Air compressor housing assembly. (Single cylinder)
	
150037S	Hold-down spring for 500 and 750 housing assemblies.
151884S	Used with FF108, FF221, FF218 Gasket
	
151940S	Used with FF108 Housing Assembly
	
153518S	Used with LF516 Bolt Seal
	
153717S	Used with LF632B Turbo head
	

154272S	Uses service part: 3302527S, 3318125S Used with AF250 Crankcase breather with steel stamped housing and cover with AF250 element.
	
156779S	Uses service part: 3318125S Used with AF250 Crankcase breather with steel stamped housing and cover, AF250 element, stopper fit, and chain on cover.
	
156780S	Uses service part: 3318125S Same as 156779S without chain.
	
156810S	Uses service part: 3302527S, 3318125S Crankcase breather.
	
159667S	Used with LF500, LF750A, LF750B Cover for bypass housing assembly
	
161917S	Element for 156810S crankcase breather.
	
161917SB	Bulk package (100) of 161917S.
	
164159S	Used with LF500, LF750A, LF750B Cover gasket
	
164159SB	Bulk package (100) of 164159S.
	

173368S	Used with LF516, LF613, LF509N Gasket used with the following head and shell combinations: ENGINE HEAD SHELL V6-140 252917 189977 V8-185 252917 189977 N & NH 177058 184386 V6-200 173285 184386 V8-185 173285 184386 V6-200 177058 173313 V8-185 177058 173313 V6-200 294353 184386 V8-185 294353 184386 V6-200 204354 184386 V8-185 204354 184386 V6-200 252990 173313 V8-185 252990 173313 V12 162671 184386 V12 180729 184386 V12 183771 184386 V12 195745 184386 V12 196079 184386 V12 199797 184386 J 199917 184386 J & C 177058 184386
	
173368SB	Bulk package (100) of 173368S.
	
202592S	Gasket
204163S	Water filter spin-on head.
	
250024S	Used with AF250 Cover gasket
	
250301S	Gasket
250383S	Used with FF107 Gasket
250457S	Gasket
250806S	One inch OD flat air filter bolt seal.
	
250843S	Used with FF108 Snap ring
	

E. PRODUCT GUIDE

250856S



Used with LF500, LF750A, LF750B Coupling assembly for use on LF500 and LF750 by-pass housing assemblies with the exception of 252281S. Also used on 10 quart power steering reservoir.

251081S

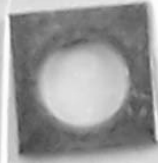

Used with FF108 Square washer for capscrew 1/2"

251091S

Used with FF108 Shell assembly

251139S

O'ring



251152S



Used with LF516 By-pass spring (relief valve located in bottom of shell)

251311S

CATERPILLAR 6F9163 Used with LF519 Gasket

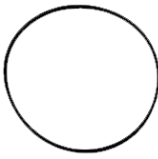

Overall Height: 0.12 (3)
Largest OD: 5.44 (138)
Cross Section: Rectangular
Largest ID: 5.20 (132)

251390S

Used with FF108, FS1201 Rubber cover gasket



251390SB

Bulk package (100) of 251390S.

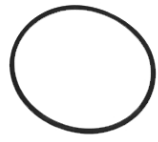

251919

Uses service part: 3902353S Coolant Immersion Heater 6' Replacement cord 120V



252011S

Spring for 2 & 4 quart power steering reservoirs.

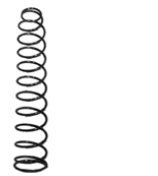

252193S

Housing used with FF178



252274S

Used with LF500, LF750A, LF750B Mounting bracket also used on 10-quart power steering reservoir 251431S.



252598S

Used with FF178 Rubber cover gasket

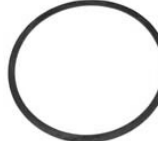

253152S

Bracket assembly for 254385S housing.



254064S

Internal retaining screens for 156810S crankcase breather.



254329S

Gasket

254387S

Dipstick for use on 4-quart power steering reservoir 254385S.



254503S

Gasket

254608S

Gasket for 255180S and 257014S crankcase breathers.

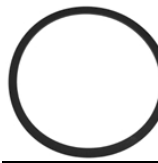

255180S

Uses service part: 255183S, 3302527S Crankcase breather for turbo applications



255183S

Used with 255180S Crankcase breather element used in 255180S assembly.



255721S

Dipstick for use on 2-quart power steering reservoir 255730S.



255724S

Cover assembly for use on 2-quart power steering reservoir 255730S.



255737S

Vented dipstick for 10-quart power steering reservoir 251431S.



255815S

Gasket for 255180S, 156810S, and 257014S crankcase breathers.

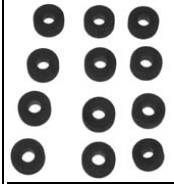

255816S

Crankcase breather washer.



256172S

Housing used with FS1201



256421S

Spring for 256546S fuel/water separator housing.



256424S

Shell assembly for fuel/water separator housing assembly 256546S. (black)



256535S

Mounting bracket for 204163S and 215617S water filter heads, 142784S, 3304315S and 212013S fuel filter heads.



256546S

Housing used with FS1201 Fuel/water separator housing assembly (black cover and shell) (FS1201 element)



256555S

Cover assembly for use on 4-quart power steering reservoir 254385S.



















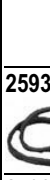



















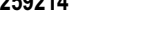

257014S



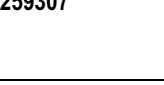

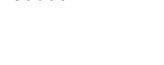







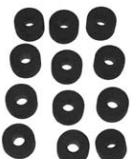















Uses service part: 3302527S Used with AF251 Crankcase breather with steel stamped housing and cover; two-stage filtration, Scott foam element (257419S)



E. PRODUCT GUIDE

<p>257419S Vapor element used with 255180S or 257014S crankcase breathers.</p> 	<p>259225 Coolant Immersion Heater for Detroit Diesel 750W/120V</p> 	<p>259311 Replacement heating element for 259283 coolant tank heater. 2250W/120V</p> 
<p>257541S Vent valve for use on fuel/water separator housing assembly.</p> 	<p>259225C Coolant Immersion Heater for Detroit Diesel 750W/120V **CSA Approved</p> 	<p>259317 Replacement heating element for 259289 coolant tank heater. 4000W/480V **CSA Approved</p> 
<p>257542S Valve assembly used in 256546S, consists of 257541S and 3302010S.</p> 	<p>259229C Coolant Immersion Heater for Caterpillar 1000W/120V **CSA Approved</p> 	<p>259319 Universal replacement tank for coolant tank heaters. 3.5 X 17.5 inches</p> 
<p>257715S Water filter head 204163S and bracket assembly.</p> 	<p>259231C Coolant Immersion Heater for Caterpillar 1500W/120V **CSA Approved</p> 	<p>259325 Replacement cord for coolant tank heaters 2000W/120V.**CSA Approved</p> 
<p>258127S Housing cover (1 pack of 258092)</p> 	<p>259246 Extension Cord 120V 15FT</p> 	<p>259326 Replacement cord for coolant tank heaters 4000W/240V**CSA Approved</p> 
<p>258814S Used with LF750A, LF750B Reinforced mounting bracket</p> 	<p>259247 Extension Cord 120V 25FT</p> 	<p>259334 Coolant Tank Heater Replacement Thermostat Sensing Unit**CSA Approved</p> 
<p>259204 Coolant Immersion Heater for Cummins 1000W/120V</p> 	<p>259248 Extension Cord 120V 50FT</p> 	<p>259346 Atomizer for some Cummins and Detroit Diesel engines. **CSA not required</p> 
<p>259205 Coolant Immersion Heater for Cummins 1000W/240V</p> 	<p>259250 Waterproof Remote Plug 240V **CSA not required</p> 	<p>259350 Atomizer for some Cummins and Perkins engines over 500 cid. **CSA not required</p> 
<p>259211 Coolant Immersion Heater for Caterpillar, Detroit Diesel, and Fiat Allis 1000W/120V</p> 	<p>259296 Replacement heating element for 259268 coolant tank heater. 750W/120V **CSA Approved</p> 	<p>259352 Atomizer **CSA not required</p> 
<p>259211C Coolant Immersion Heater for Caterpillar, Detroit Diesel, Fiat Allis 1000W/120V **CSA Approved</p> 	<p>259302 Replacement heating element for 259274 water-tight coolant tank heater. 1500W/120V</p> 	<p>259354 Atomizer for some Cummins and International Harvester industrial engines.**CSA not required</p> 
<p>259214 Coolant Immersion Heater for Detroit Diesel 1000W/120V</p> 	<p>259305 Coolant Tank Replacement Heating Element **CSA Approved</p> 	<p>259367 6cc valve for electric ether start kits. **CSA not required</p> 
<p>259216 Coolant Immersion Heater for Detroit Diesel 1500W/120V</p> 	<p>259307 Replacement heating element for 259279 water-tight coolant tank heater. 2000W/120V</p> 	<p>259369 48" Nylon tubing for use with ether start kits. **CSA not required</p> 
<p>259218 Coolant Immersion Heater for Detroit Diesel 1000W/120V</p> 	<p>259309 Replacement heating element for 259281 water-tight coolant tank heater. 2000W/240V</p> 	<p>259310 Replacement heating element for 259282 coolant tank heater. 2000W/480V **CSA Approved</p> 
<p>259223 Coolant Immersion Heater for Detroit Diesel 1500W/240V</p> 		

E. PRODUCT GUIDE

<p>259370 Start Kit **CSA not required</p> 	<p>323344S Used with HF6054 Gasket</p> 	<p>3302180S Gasket for use on Cummins crankcase breathers 257014S and 255180S.</p> 
<p>259371 Start Kit **CSA not required</p> 	<p>330818S Gasket Pack</p> <p>Overall Height: 0.22 (5) Largest OD: 2.83 (72) Cross Section: Rectangular Largest ID: 2.46 (63)</p>	<p>3302367S Head used with FF202, FS1216, FS1006 Fuel filter head</p> 
<p>259372 Start Kit **CSA not required</p> 	<p>333763S Used with HF6184, HF6079, HF6165 Gasket</p> 	<p>3302527S Used with 154272S, 156810S, 257014S, 255180S Wing nut for use with some crankcase breathers.</p> 
<p>259373 Start Kit **CSA not required</p>	<p>394694S Used with AK17 Hump Hose</p>	<p>3302657 Low Pressure Ether Cyl. 90 psi.(Non-US) (For Canada use 259345 only)</p>
<p>259375 12CC Mechanical Start Kit **CSA not required</p>	<p>3001483S Used with LF670 Lock plate spin-on adaptor for Detroit Diesel engines 3301340S.</p> 	<p>3302696 84" Control Cable **CSA not required</p> 
<p>259377 Thermal switch (100 degrees) 1/2" NPT for electric kits. **CSA not required</p> 	<p>340113S Plastic crankcase breather for Cummins applications.</p> 	<p>3302698 Cylinder Clamp **CSA not required</p> 
<p>259379C Coolant Immersion Heater for some Caterpillar and Detroit Diesel engines. 1500W/120V. **CSA Approved</p> 	<p>3300518S Band wrench for 5 inch O.D. spin-ons.</p> 	<p>3302699 Compression Sleeve **CSA not required</p> 
<p>259384 Ether Start Kit **CSA not required</p> 	<p>3301387S Used with LF500, LF750A, LF750B Strap. For bulk see 145665SB.</p> 	<p>3302700 90 degree Valve Fitting **CSA not required</p> 
<p>259386 Start Kit **CSA not required</p>	<p>3301922S Vented dipstick 10-quart power steering reservoir.</p> 	<p>3303104 Coolant Immersion Heater for Mack 1500W/120V</p> 
<p>259387 Start Kit **CSA not required</p>	<p>3301949S Used with LF516 11.3 inch capscrew</p> 	<p>3303104C Coolant Immersion Heater for Mack 1500W/120V **CSA Approved</p> 
<p>259390S 6-hole gasket for use with Cummins coolant heaters. **CSA not required</p>	<p>3301954S Used with LF516 14 inch capscrew</p> 	<p>3303311 Atomizer **CSA not required</p> 
<p>284401S Carton for customer maintenance kit containing a LF750 element.</p>	<p>3302102S Used with FF178 Stat-o-seal</p> 	<p>3303427S Used with 3309188 O'ring used with some Cummins block heaters.</p> 
<p>285066S Insert for custom maintenance kit not containing a LF750 element.</p>	<p>3302134S Used with LF509N Stat-o-seal washer</p> 	
<p>317237S Used with HF6118, LF509N Cover gasket</p>		
<p>317506S Gasket</p>		

E. PRODUCT GUIDE

3303779 Uses service part: 3303899S
12-24V Electric Ether Starting
Kit **CSA not required



3303780 Uses service part: 3303899S
Mechanical Starting Fluid Kit to
450 CID **CSA not required



3303781 Uses service part: 3303899S
Mechanical Starting Fluid Kit
450 to 900 CID **CSA not
required



3303897 Triplex Cord - 120V

3303897C Triplex Cord **CSA Approved

3303899S Used with 3310588, 3830394,
3303779, 3830396, 3303780,
3303781, 3313273, 3830397,
3316413, 3830395 Cork
gasket for use with ether
cylinder.



3303975S Fuel System Service Part.
Hex Nut Fam 9,13

3304015 12CC Manual Valve

3304016 12CC Electric Valve **CSA
Approved



3304017 C W Aids Union "T" **CSA
Approved TE Connector for
Ether Valve



3304018 Electric Starting Fluid System
Switch **CSA Approved



3304173S Head used with LF777 Adaptor
head, remote mount.



3304274S Used with FF202 Inlet and
outlet fitting for use with Detroit
Diesel; converts from 7/8"-
14UNF to 3/8"NPT



3304865 Ammeter **CSA not required

3304868 Generator Brushes (DC
Starter) **CSA not required

3305315S Wing screw for 2-quart and 4-
quart power steering reservoir.



3305647 Coolant Immersion Heater for
Detroit Diesel 1500W/120V



3305647C Coolant Immersion Heater for
Detroit Diesel 1500W/120V
**CSA Approved



3305648 Coolant Immersion Heater for
Detroit Diesel 1500W/240V



3305648C Coolant Immersion Heater for
Detroit Diesel 1500W/240V

3305783 Thermostat for Circulation
Fuel Warmer



3305996S Used with HF6054 Gasket



3305997S Used with HF6054 Gasket



3306001S Used with HF6054 Gasket



3306006 1000W/120V Block Heater for
Detroit 8.2L, V-8, 501 CID and
Cummins ISC, ISL engine



3306006C Coolant Immersion Heater for
Detroit 8.2L engine
1000W/120V **CSA Approved
Navistar/International 444E
and T444E 1994 models and
newer



3306007 Coolant Immersion Heater for
Detroit 8.2L 1000W/240V



3307046 Economy Model Tank Heater
1500W/120V



3307059 Economy Tank Heater
1000W/120V **CSA Approved



3307060 Economy Model Tank Heater
2000W/120V **CSA Approved



3307454S Housing used with FF246
Uses service part: 3307455S
Bulk tank fuel filter (gasohol)



3307455S Used with 3307454S
Replacement bowl



3307647S Spring used in 250825S and
250826S; replaced 150037S in
these applications.



3307670 Coolant Immersion Heater for
Caterpillar and Detroit Diesel
1000W/120V



3307672 Coolant Immersion Heater for
Caterpillar 1500W/120V



3308112S Used with FF191 Gasket

3308694S CATERPILLAR 5P3092 Used
with HF6083 Gasket



3308720 Coolant Immersion Heater for
IHC/Navistar Applications
600W/120V

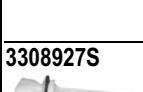

3308927S Dipstick used in 3308935S
power steering reservoir.





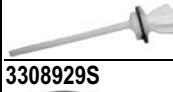











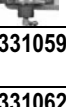





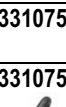

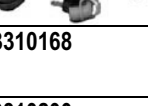



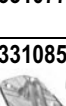

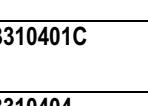

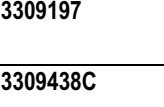





3308928S Dipstick used in 2-quart power
steering reservoir.





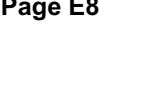



































3308929S Cover assembly used on 4-
quart power steering reservoir.



E. PRODUCT GUIDE

3309054S  Seal assembly in 2-quart and 4-quart power steering reservoirs.	3310049S  Gasket for use with some block heaters.	3310591  E-Z Mount Valve **CSA not required
3309188  Uses service part: 3303427S, 3835426S Coolant Immersion Heater for Cummins L-10 and M-11. 1500W/120V	3310063  Replacement Heater Element 1500W/120V	3310593  Atomizer **CSA not required
3309188C  Coolant Immersion Heater for Cummins L10. 1500W/120V **CSA Approved	3310063C  Replacement Immersion Heater Element. 1500W/120V **CSA Approved	3310629S  Mounting bracket for 4-quart power steering reservoir.
3309189  Coolant Immersion Heater for Cummins L-10 and M-11. 1500W/240V	3310064  Replacement Heater Element 1500W/240V	3310750  Temperature Control
3309190  Coolant Immersion Heater for Mack. 1500W/120V	3310168  Replacement Heater Element for 3310400	3310751C  Coolant Immersion Heater for IHC. 1250W/120V **CSA Approved
3309190C  Coolant Immersion heater for Mack 1500W/120V **CSA Approved	3310200  Thermo Blend Fuel Warmer **CSA not required	3310776S  Gasket
3309196  Coolant Immersion Heater for Mack. 1500W/120V	3310400C  Coolant Immersion Heater for Cummins V 1500W/120V	3310777S  Gasket
3309197  Coolant Immersion Heater for Mack. 1500W/240V	3310401C  Coolant Immersion Heater for Cummins V 1500W/240V	3310858  Coolant Immersion Heater for Cummins. 1500W/120V (With Cord) See 3310839 for heater only.
3309438C  Igniter Switch for 30,000 BTU Propane Tank Heater	3310404  Coolant Immersion Heater for Agricultural Applications 600W/120V	3310858C  Coolant Immersion Heater for Cummins. 1500W/120V **CSA Approved
3309490S  Used with FS1242B Replacement O-ring gasket for use with self-venting drain valve screws used on all Superfilter Plus fuel/water separator assemblies.	3310478C  10' Replacement Cord 120V **CSA Approved	3310859  Coolant Immersion Heater for Cummins. 1500W/240V
3309738  Coolant Immersion Heater for Cummins. 1500W/120V	3310553  Oil Pressure Switch **CSA Approved	3311468S  Strap wrench.
3309738C  Coolant Immersion Heater for Cummins. 1500W/120V **CSA Approved	3310587S  Cutter for spin-on filters. At this time, Fleetguard does not sell replacement blades.	3311815  Remote Plug-In W/Cord
3309739  Coolant Immersion Heater for Cummins. 1500W/240V	3310588  Uses service part: 3303899S E-Z Mount Start Kit **CSA not required	3312054S  Used with 3303782S, 3314849S Bracket
		3312097S  Used with HF6704 Gasket for use with some hydraulic filters. (Rectangular cross section)
		3312307S 2-quart power steering reservoir gasket. Overall Height: 0.07 (2) Largest OD: 5.10 (130) Cross Section: Rectangular Largest ID: 4.38 (111)

















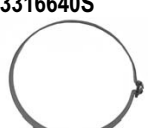
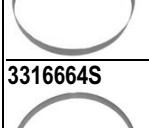





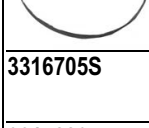

E. PRODUCT GUIDE

3312308S  2-quart power steering reservoir cover.	3313276  Battery Warmer Blanket **CSA Approved	3316570S  90 degree elbow for use with air cleaners.
3312715S Gasket	3316406  10', 120V Weather Proof Plug and Cord	3316571S  90 degree elbow for use with air cleaners.
3312925 Replacement Element for 3312920 **CSA Approved	3316408 Coolant Immersion Heater for Case. 1500W/120V	3316573S  90 degree elbow for use with air cleaners.
3312927 Replacement Element for 3312922 **CSA Approved	3316409 Coolant Immersion Heater for John Deere. 1000W/120V	3316576S  90 degree elbow for use with air cleaners.
3312928 Replacement Element for 3312923 **CSA Approved	3316410 Atomizer **CSA not required	3316577S  90 degree elbow for use with air cleaners.
3312933 Replacement Element for 3312930.	3316413 Uses service part: 3303899S Electric Starting Kit 250-450 CID **CSA not required	3316578S  90 degree elbow for use with air cleaners.
3312934 Replacement Element for 3312931.	3316564S  90 degree elbow for use with air cleaners.	3316579S  45 degree elbow for use with air cleaners.
3312942 100-120 degree thermostat	3316565S  90 degree elbow for use with air cleaners.	3316580S  45 degree elbow for use with air cleaners.
3312943 120-140 degree thermostat	3316566S  90 degree elbow for use with air cleaners.	3316581S  45 degree elbow for use with air cleaners.
3313095S Used with HF6505, HF6504 Gasket Overall Height: 0.27 (7) Largest OD: 2.83 (72) Cross Section: Rectangular Largest ID: 2.46 (63)	3316567S  90 degree elbow for use with air cleaners.	3316582S  45 degree elbow for use with air cleaners.
3313182  Coolant Immersion Heater for IHC 9L. 1000W/120V1993 and older	3316567S  90 degree elbow for use with air cleaners.	3316581S  45 degree elbow for use with air cleaners.
3313268  Coolant Immersion Heater for Perkins. 600W/120V **CSA Approved	3316568S  90 degree elbow for use with air cleaners.	3316582S  45 degree elbow for use with air cleaners.
3313270  Coolant Immersion Heater for Agricultural Applications. 400W/120V	3316569S  90 degree elbow for use with air cleaners.	3316581S  45 degree elbow for use with air cleaners.
3313272  Coolant Immersion Heater for Consolidated Dsl. 750W/120V	3316569S  90 degree elbow for use with air cleaners.	3316582S  45 degree elbow for use with air cleaners.
3313272C  Coolant Immersion Heater for Consolidated Dsl. 400W/120V **CSA Approved	3316569S  90 degree elbow for use with air cleaners.	3316581S  45 degree elbow for use with air cleaners.
3313273  Uses service part: 3303899S Ether Start Kit **CSA not required Includes atomizers 3303311, 259350, 259346	3316569S  90 degree elbow for use with air cleaners.	3316581S  45 degree elbow for use with air cleaners.
3313274  All Purpose Magnetic Heater **CSA not required	3316569S  90 degree elbow for use with air cleaners.	3316581S  45 degree elbow for use with air cleaners.

















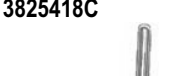

E. PRODUCT GUIDE

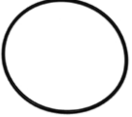
<p>3316583S 45 degree elbow for use with air cleaners.</p>	<p>3316593S 90 degree reducing elbow for use with air cleaners.</p> 	<p>3316612S Hump hose for use with air cleaners.</p> 
<p>3316584S 45 degree elbow for use with air cleaners.</p> 	<p>3316594S 45 degree reducing elbow for use with air cleaners.6" to 5"</p> 	<p>3316613S Hump hose for use with air cleaners.</p> 
<p>3316585S 45 degree elbow for use with air cleaners</p> 	<p>3316595S 45 degree reducing elbow for use with air cleaners.</p> 	<p>3316614S Hump hose for use with air cleaners.</p> 
<p>3316586S 45 degree elbow for use with air cleaners.</p> 	<p>3316600S Special elbow for use with air cleaners.</p> 	<p>3316615S Hump hose for use with air cleaners.</p> 
<p>3316587S 45 degree elbow for use with air cleaners.</p> 	<p>3316601S Special elbow for use with air cleaners.</p>	<p>3316616S Hump hose reducer for use with air cleaners.</p> 
<p>3316588S 45 degree elbow for use with air cleaners.</p> 	<p>3316603S Special elbow for use with air cleaners.</p>	<p>3316617S Hump hose reducer for use with air cleaners.</p> 
<p>3316589S 90 degree reducing elbow for use with air cleaners.</p> 	<p>3316604S Special elbow for use with air cleaners.</p>	<p>3316618S Hump hose reducer for use with air cleaners.</p> 
<p>3316590S 90 degree reducing elbow for use with air cleaners.</p> 	<p>3316606S Hump hose for use with air cleaners</p> 	<p>3316619S Hump hose reducer for use with air cleaners.</p> 
<p>3316591S 90 degree reducing elbow for use with air cleaners.</p> 	<p>3316607S Hump hose for use with air cleaners.</p> 	<p>3316620S Hump hose reducer for use with air cleaners.</p> 
<p>3316592S 90 degree reducing elbow for use with air cleaners.</p> 	<p>3316609S Hump hose for use with air cleaners.</p> 	<p>3316621S Hump hose reducer for use with air cleaners.</p> 
<p>3316592S 90 degree reducing elbow for use with air cleaners.</p> 	<p>3316610S Hump hose for use with air cleaners.</p>	<p>3316611S Hump hose for use with air cleaners.</p> 





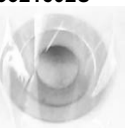





















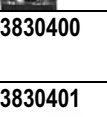





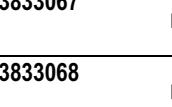
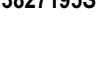

E. PRODUCT GUIDE

3316622S  Hump hose reducer for use with air cleaners.	3316635S  Mounting band for use with air cleaners.	3316661S  "T" bar air inlet clamps for use with air cleaners.
3316623S  Hump hose reducer for use with air cleaners.	3316636S  Mounting band for use with air cleaners.	3316662S  "T" bar air inlet clamps for use with air cleaners.
3316624S  Hump hose reducer for use with air cleaners.	3316640S  Mounting band for use with air cleaners.	3316663S  "T" bar air inlet clamps for use with air cleaners.
3316625S  Hump hose reducer for use with air cleaners.	3316653S  "T" bar air inlet clamps for use with air cleaners.	3316664S  "T" bar air inlet clamps for use with air cleaners.
3316626S  Hump hose reducer for use with air cleaners.	3316654S  "T" bar air inlet clamps for use with air cleaners.	3316665S  "T" bar air inlet clamps for use with air cleaners.
3316627S  Hump hose reducer for use with air cleaners.	3316656S  "T" bar air inlet clamps for use with air cleaners.	3316666S  "T" bar air inlet clamps for use with air cleaners.
3316628S  Hump hose reducer for use with air cleaners.	3316657S  "T" bar air inlet clamps for use with air cleaners.	3316705S Used with FF125 Housing cover gasket
3316629S  Reducer insert sleeve for use with air cleaners.	3316658S  "T" bar air inlet clamps for use with air cleaners.	3317283 Coolant Immersion Heater for Cummins. 1500W/120V
3316630S  Reducer insert sleeve for use with air cleaners.	3316659S  "T" bar air inlet clamps for use with air cleaners.	3317283C Bulk pack heater with cord. 1500W/120V **CSA Approved
3316631S  Reducer insert sleeve for use with air cleaners.	3316660S  "T" bar air inlet clamps for use with air cleaners.	3318022S Band wrench for 4.2" and 4.6" O.D. spin-ons.
3316632S  Reducer insert sleeve for use with air cleaners.		3318125S Used with 154272S, 156780S, 156779S, 156810S Gasket used in crankcase breather assemblies.
3316633S  Reducer insert sleeve for use with air cleaners.		3318168S Probalyzer cap used with fluid analysis kits.







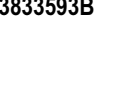
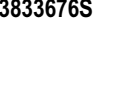

























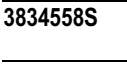

E. PRODUCT GUIDE

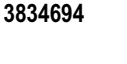
3318169S  Mini gauge plug used with fluid analysis kits.	3323007S Used with FF146 Gasket used with fuel filters Overall Height: 0.12 (3) Cross Section:Rectangular Largest ID: 2.89 (74)	3825410 6CC Mech Ether Kit(C Series) **CSA not required
3318304S Used with HF6244 Gasket	3323008S Used with FF147, FF5054 Optional gasket. Enclosed with FF5228.	3825411  Heater (C Series) 1000W/120VUses Cummins gasket 3910517
3320223S Used with FF5105 Gasket Overall Height: 0.14 (4) Cross Section:Rectangular Largest ID: 4.84 (123)	 3323009S Used with FF147, FF146 Optional Gasket Overall Height: 0.12 (3) Cross Section:Round Largest ID: 3.72 (95)	3825414C  1/2" Oil Pan Heater **CSA Approved 150W/120V
3320513S  Removal tool	3323010S Used with FF146 Optional gasket Overall Height: 0.08 (2) Cross Section:Rectangular Largest ID: 2.99 (76)	3825415C  1" Oil Pan Heater 150W/120V **CSA Approved
3320515S  Removal tool	3323010S Used with FF146 Optional gasket Overall Height: 0.12 (3) Cross Section:Round Largest ID: 3.86 (98)	3825416  22MM Oil Pan Heater 150W/120V
3320571S Used with HF6059, HF6060 Optional gasket Overall Height: 0.12 (3) Cross Section:Rectangular Largest ID: 1.83 (47)	3320224S Used with FF5105 Gasket	3825417C  1/2" Oil Pan Heater **CSA Approved 300W/120V
3320958S Cable socket	3323483S Replaced by 3923925S Nylon tubing, used for cold weather aids. Packaged 150 meters of tubing per carton.	3825418C  1" Oil Pan Heater 300W/120V **CSA Approved
3320966S Cable socket	3324564S Used with FF147 Optional gasket	3825419C  22MM Oil Pan Heater 300W/120V **CSA Approved
3320967S Cable socket	 3328464S Gasket	3825421  22MM Oil Pan Heater 300W/240V
3321569S Insulator	3328567S Gasket	3825422  1/2" Oil Pan Heater 450W/120V
3321577S PTC Fuel Warmer **CSA not required	3328568S Gasket	3825423  1/2" Oil Pan Heater 300W/240V
3321578S PTC Fuel Warmer **CSA not required	3329059S Electric cable for heater 2 conductors, no tape.	3825424  120V Y-Cord with Thermostat
3321579S PTC Fuel Warmer **CSA not required	3329992S Used with LF3998, LF3999 Set of gaskets containing 3328578, 3329993, 3329994	3825403  Tank Heater 1000W/240V
3321580S PTC Fuel Warmer **CSA not required	3625120S Used with LF4072 Optional gasket Only for RABA engine-Application IKARUS bus	3825405 Unfilled Ether Cyl. **CSA not required
3321592S  Fitting instructions for PTC Heater Kit	3825406C  5' Replacement Cord 120V **CSA Approved	3825408 3CC Mechanical Ether Kit (B Series) **CSA not required
3321967S Single cable	3825409  6CC 12V Ether Kit (C Series) **CSA not required	3825409 6CC 12V Ether Kit (C Series) **CSA not required
3321968S Cable		
3321969S Single cable		
3321970S Twin cable		
3321978S Fitting instructions for PTC Heater Kit		
3322951S Used with LF3521		

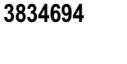

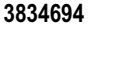

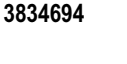





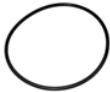













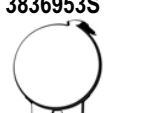
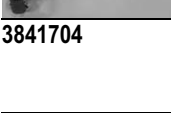
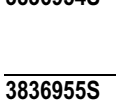

E. PRODUCT GUIDE

3825425  240V Y-Cord With Thermostat For Oil Pan Heaters	3830394  Uses service part: 3303899S E-Z Mount 24V Start Kit **CSA not required	3832164  120V Y-Cord w/Thermostat (55-75 degrees)
3825760  Coolant Immersion Heater for Cummins C Series 1000W/240V	3830395  Uses service part: 3303899S 24V Start Kit **CSA not required	3832165  240V Y-Cord w/Thermostat (55-75%)
3826036S  Dash mount filter minder restriction gauge.	3830396  Uses service part: 3303899S 24V Start Kit **CSA not required	3832216  Coolant Immersion Heater
3826037  12cc 12-24 volt Ether Start Kit for KV12 & KV16 engine w/side mounted aftercooler **CSA Approved	3830397  Uses service part: 3303899S 24V Start Kit **CSA not required Includes atomizers 3303311, 259350, 259346	3832218  Engine Heater
3826255  Coolant Immersion Heater for Cummins B Series 750W/240V	3830400  6cc Valve for 24V E-Z Mount Start Kit **CSA not required	3832350S  Viton Gasket
3826332S  Used with LF3000 Retro Kit for Cummins Big Cam III and IV	3830401  12cc Valve **CSA not required	3832637S  CUMMINS 3284085 Insert
3826337S  Mounting bracket for 2-quart power steering reservoir.	3830497S  1.5" O.D. flat filter bolt seal.	3832879S  Used with FF127, HF6118, HF6270, HF6271, LF509N Gasket
3826362S  Used with LF3000 Small Oring	3831773S  Service gasket of LF3000 Large gasket used with LF3000 Retro Kit.	3833066  Coolant Immersion Heater for Nissan FE6. 1500W/120V
3826373  Thermal Switch w/45 degree 1/2" NPT, for electric start kits. **CSA not required	3831852S  Used with FS1232V, FS1253V, FS1253, FS1232 Drain Valve Connector Assembly	3833067  Coolant Immersion Heater for Nissan NE6. 1500W/120V
3827195S  Head used with LF3000 Remote mount head (1-1/4 inch inlet/outlet)	3831871S  Used with FS1015, FS1242, FS1233, FS19511, FS1241, FS1240, FS1234B, FS1234 Replacement bowl	3833068  Coolant Immersion Heater for Mitsubishi Fuso. 3/4" NPT **CSA Approved
3830327  Replacement Heating Element For 3896711	3832163  Cummins Side Plate Brazed Element W/Cord 1500W/120V	3833069  Coolant Immersion Heater for Cummins BC IV (Rear port). 1500W/120V
3830329  2000W/240V Tank Heater **CSA Approved	3833593A  Standard Replacement Ether (120 psi.)Purchase Quantity 1 To 96 Units	3833593B  Standard Replacement Ether (120 psi.)Purchase Quantity 97 Or More Units **CSA Approved
		3833676S  Mounting band for use with air cleaners.





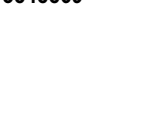
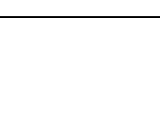

















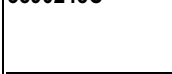



E. PRODUCT GUIDE

3833677S  Mounting band for use with air cleaners.	3833697S  Air inlet stack cap for use with air cleaners.	3835118S  Used with 3837317S Cummins 3943780 Threaded insert to use heater with Superfilter Plus line with 3833198S and 3905661S heads.
3833678S  Mounting band for use with air cleaners.	3833698S  Air inlet stack cap for use with air cleaners.	3835425 Atomizer **CSA not required
3833679S  Mounting band for use with air cleaners.	3833699S  Air inlet stack cap for use with air cleaners.	3835426S  Used with 3309188 Hexagonal Nut Package **CSA not required
3833680S  Mounting band for use with air cleaners.	3833700S  Air inlet stack cap for use with air cleaners.	3835603 Starting Fluid **CSA not required
3833684S Brass wing nut 7/16" w/14 for use with air cleaners.	3834123S  Head used with LF3000 Remote mount head (1-5/16 inch inlet/outlet)	3835604A Starting Fluid **CSA not required
3833685S Lock nut for use on some air cleaners.	3834185S  Used with 3837317S, 3847102S For Upgrade, use 3958485S Replacement gasket for PTC fuel heater kits. Overall Height: 0.17 (4) Largest OD: 2.74 (70) Cross Section: Rectangular Largest ID: 2.46 (62)	3835841S  Used with AF253, AF1650 Gasket (foam gasket with adhesive on one side)(5.416 ID/7.610 OD/.265 thick)
3833686S Lock nut for use on some air cleaners.	3834217S  Uses service part: 3834335S Used with FS1242B Water in fuel indicator kit for Superfilter Plus product line. (For use on 12 volt DC systems only.)	3835842S  Used with AF1650, AF253 Gasket (foam gasket with adhesive on one side)(7.716 ID/10.155 OD/.252 thick)
3833688S  Lock nut for use on some air cleaners.	3834335S  CUMMINS 3613643 Used with FS1242K, 3834217S Replacement WIF sensor for use with clear bowl used on the Superfilter Plus fuel filter/water separator assemblies.	3836029AS Used with FS1242B, FS1242K Complete fuel heater installation kit (300 watt/12 volt) **CSA Approved Gaskets Included: 3837316S & 3834185S
3833689S  Wing nut for use on some air cleaners.	3834513  Coolant Immersion Heater for Cummins K-Series 1500W/120V	3836032S  Fuel heater element for 3836029S kit (300 watt) Includes 3834185 gasket
3833690S Lock nut for use on some air cleaners.	3834513C  Coolant Immersion Heater for Cummins K-Series. 1500W/120V **CSA not required	3836091S  Head used with LF3000 Remote mount head (1-5/8 straight threads inlet/outlet)
3833691S  Dust valve for "2-stage plus safety" and "2-stage" air cleaners.	3834514  Coolant Immersion Heater for Cummins K-Series. 1500W/240V	3836165S "L" shaped gasket for John Deere application RE41257.
3833692S  Air inlet stack cap for use with air cleaners.	3834558S  Oil Analysis Kit	3836258 Starter Fluid
3833693S  Air inlet stack cap for use with air cleaners.	3834694  Replacement Heating Element for 3317938 Tank Heater	3836308S Hump hose for use with air cleaners.
3833694S  Air inlet stack cap for use with air cleaners.	3834694  Replacement Heating Element for 3317938 Tank Heater	3836931S Mounting clamps for ECO-SE air cleaners.
3833696S  Air inlet stack cap for use with air cleaners.	3834694  Replacement Heating Element for 3317938 Tank Heater	3836932S  Mounting clamps for ECO-SE air cleaners.
3833696S  Air inlet stack cap for use with air cleaners.	3834694  Replacement Heating Element for 3317938 Tank Heater	3836933S  Mounting clamps for ECO-SE air cleaners.

































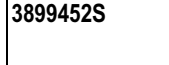



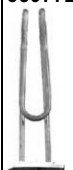

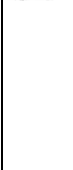
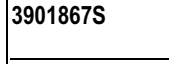
E. PRODUCT GUIDE

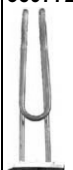
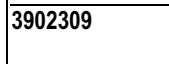
3836943S  Inlet adaptor for ECOII air cleaners.	3838228S  CATERPILLAR 6D9157 Used with HF6202, HF6344 Gasket Gasket: 3838228	3843722S  Used with 3847102S, 3894689S Cord w/Thermostat used on 3847102S and 3894689S fuel system service parts
3836945S  Inlet adaptor for ECOII air cleaners.	3838229S  CATERPILLAR 8F8882 Used with HF6097 Gasket Gasket: 3838229	3845400S  Used with 3847102S, 3889181S, 3889182S Service Kit, Fuel Strainer Screen, Includes 3841883 Lock Nut and 3842021 Gasket.
3836946S  Inlet adaptor for ECOII air cleaners.	3838290S  Used with LF691A Band wrench	3845969  12cc/24V valve starting Kit (12V version use 3826037) **CSA not required
3836947S Combination water separator and inlet adaptor for ECOII air cleaners.	3841697  Coolant Immersion Heater for Caterpillar 3176. 1500W/120V**CSA Approved	3845970  12cc/24V valve starting kit (12V version use 259385) **CSA not required
3836948S Combination water separator and inlet adaptor for ECOII air cleaners.	3841701  Coolant Immersion Heater for Caterpillar 3116. 1000W/120V**CSA Approved	3845971  24 volt valve starting kit (12V version use 259384) **CSA not required
3836950S Combination water separator and inlet adaptor for ECOII air cleaners.	3841702  Coolant Immersion Heater for Detroit 60 Series 1500W/120V**CSA Approved	3846568S  Remote mount lube filter head for Cummins C series. (LF3000 element used)
3836951S  Mounting clamp for ECOII air cleaners.	3841703  Coolant Immersion Heater for Detroit 60 Series 1500W/240V	3846751 Filter crusher for use on larger truck filters or multiple smaller filters.
3836952S  Mounting clamp for ECOII air cleaners.	3841704  Weatherproof Receptacle Bracket (Square) **CSA not required	3846752 Filter crusher for extremely high volume applications.
3836953S  Used with AH19036 Mounting clamp for ECOII air cleaners.	3841706  Coolant Immersion Heater for Ford 6.6 & 7.8L 1250W/240V	3847102S  Uses service part: 3834185S, 3843722S, 3845400S, 3928013S Cummins Fuel Strainer for Mid-range engines. Complete assembly.
3836954S Pressure tap sleeve with service indicator for ECOII air cleaners.	3841707  Coolant Immersion Heater for Ford 6.6 & 7.8L 1250W/120V	3847372S  Used with AF25005 Clamp Fastener Package
3836955S Pressure tap sleeve with service indicator for ECOII air cleaners.	3841708  Coolant Immersion Heater for Mack E7 1500W/120V	3847940S  CUMMINS 3932595 Cord, W/Thermostat
3836956S Pressure tap sleeve with service indicator for ECOII air cleaners.	3841710  Heatsticker (Flexible Hot Pad Heater) **CSA not required 150W/120V	3848869  Remote Mount Filter Minder Gauge (35" restriction)
3837317S  Uses service part: 255622S, 3834185S, 3835118S, 3837316S Retrofit adaptor kit for use of Superfilter Plus heater with existing Cummins fuel filter head. (Includes gaskets, adaptor disk, threaded insert, industrial loctite)	3841879S  Used with 3889182S, 3889181S Fuel Strainer used With FS1251	



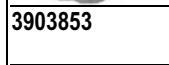
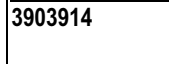

















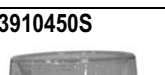

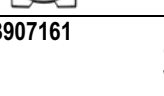



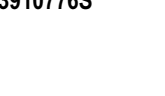

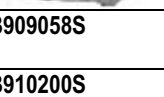







E. PRODUCT GUIDE

<p>3888619 12V EZ Mount Start Kit **CSA not required</p> 	<p>3890243C Coolant Immersion Heater for Onan 1000W/120V **CSA Approved</p> 	<p>3894967S CASE 401849A1 Used with FS19519, FS19519V Valve and Sensor</p> 
<p>3888706 Contamination Monitor which includes printer, carrying case, batteries, trace heating element, lamp, printer paper and ribbon, DC adaptor and fuse.</p>	<p>3890244C Coolant Immersion Heater for Onan 1000W/240V **CSA Approved</p> 	<p>3894971S Used with CH44105 Gasket</p> 
<p>3888707 Industrial sensor with 5 - 26 GPM flow rate @ 6000 PSI</p>	<p>3890245C Coolant Tank Heater for Onan 1500W/120V **CSA Approved (Thermostat 100 to 120 degrees)</p> 	<p>3894972S Service gasket of CH44105, CH44110, CH44120</p> 
<p>3888708 Industrial sensor rated at 21 - 100 GPM flow rate @ 6000 PSI</p>	<p>3890246C Coolant Immersion Heater for Onan 1500W/240V **CSA Approved</p> 	<p>3894973S Service gasket of CH44105, CH44110, CH44115, CH44120</p> <p>Overall Height: 0.21 (5) Largest OD: 6.02 (153) Cross Section: Round Largest ID: 5.60 (142)</p> 
<p>3888709 Single point sampler with carrying case and two hook-up hoses</p>	<p>3890247C Coolant Immersion Heater for Onan 1800W/120V **CSA Approved</p> 	<p>3894975S Used with CH44105, CH44110, CH44115, CH44120 Service Kit for Centrifuge. Includes (1) Rotor O-Ring, (1) Cone Stack Assembly, (1) Baffle Assembly, (1) CSA Turbine Can, (1) Can nut, (1) Jet Nut, and (1) FG Rotor shaft sub assembly.</p> 
<p>3889181S FORD F4HZ9162B Uses service part: 3841879S, 3845400S Complete assembly.</p> 	<p>3890248C Coolant Immersion Heater for Onan 2000W/240V **CSA Approved</p> 	<p>3894976S Used with CH44115, CH44105, CH44110 Shell Assembly</p> 
<p>3889182S Uses service part: 3841879S, 3845400S Fuel Strainer for Consolidated Diesel Co. Complete assembly.</p> 	<p>3891506S Insert, reducer</p> 	<p>3894977S Used with CH44120, CH44105 Clamp</p> 
<p>3889493S Threaded Insert</p> 	<p>3892256 Heat Transfer Fluid Additive</p>	<p>3895540S Replaces ST101106 Hydraulic Filter Head</p> 
<p>3889513S CUMMINS 3889513 Hydraulic Filter Head</p>	<p>3892460 Oberg P100WM Fuel System Service Part</p>	<p>3895546S Replaces 6700FP17A00 Hydraulic Filter Head</p>
<p>3889610 CUMMINS 196520 Die Cut Media Disk Valve Quantity 10,000</p> 	<p>3893692S Head used with NG5900 6B & L10 Engines Cummins 3606711 Head & O'ring Uses NG5900 element</p> 	<p>3895593S Replaces 6500BP05A25 Hydraulic Filter Head</p>
<p>3889610S Die Cut Media Disk Valve Quantity 500</p> 	<p>3893762C Fleetcool Concentrate Additive</p>	<p>3895630S Head and Filter Assembly</p>
<p>3890105S CUMMINS 3681120 Gasket service pack</p>	<p>3893866S O'ring Plug (2) Cummins 3943645</p>	<p>3896018 Universal Concentrate Additive</p>
<p>3890242C Coolant Immersion Heater for Onan 500W/120V **CSA Approved</p> 	<p>3894499 Immersion Heater 1250 Watt 120 Volt **CSA Approved</p> 	<p>3896692 Coolant Tank Heater 1500W/120V **CSA Approved</p> 
	<p>3894901S CUMMINS 3942357 Temperature Sensor for 12V heater used on Cummins ISB spin-on fuel filter</p>	<p>3896693 Coolant Tank Heater 1500W/240V **CSA Approved</p>  <p>3896694 Coolant Tank Heater 1500W/480V **CSA Approved</p> 

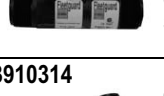
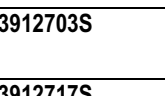



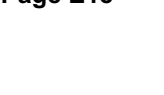





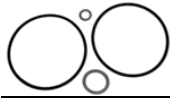







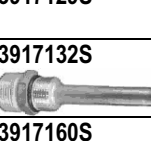

E. PRODUCT GUIDE

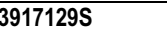
3896695  Coolant Tank Heater 2000W/120V **CSA Approved	3897711  Replacement heating element for 3896694 coolant tank heater. 1500W/480V **CSA Approved	3897726  Used with 3896711 Replacement heating element for 3896711 coolant tank heater. 2500W/240V **CSA Approved
3896696  Coolant Tank Heater 2000W/240V **CSA Approved	3897712  Replacement heating element for 3896695 coolant tank heater. 2000W/120V **CSA Approved	3898280S  Used with FS19598 Valve shut-off for FWS assembly
3896697  Coolant Tank Heater 2000W/480V **CSA Approved	3897714  Replacement heating element for 3896697 coolant tank heater. 2000W/480V **CSA Approved	3898281S  CUMMINS 3931582, CHRYSLER 4883052 Used with FS19598 Head assembly for FS19528 assembly.
3896698  Coolant Tank Heater 2250W/120V **CSA Approved	3897715  Replacement heating element for 3896698 coolant tank heater. 2250W/120V **CSA Approved	3898282S  CUMMINS 3931584, CHRYSLER 4882441 Used with FS19598 Housing Assembly
3896699  Coolant Tank Heater 2500W/240V **CSA Approved	3897716  Replacement heating element for 3896699 coolant tank heater. 2500W/240V **CSA Approved	3898285S  CUMMINS 3931489, CHRYSLER 4882437 Used with FS19598 FS Sensor
3896700  Coolant Tank Heater 2500W/480V **CSA Approved	3897717  Replacement heating element for 3896700 coolant tank heater. 2500W/480V **CSA Approved	3898526S  12V Thermostat
3896701  Coolant Tank Heater 4000W/240V **CSA Approved	3897718  Replacement heating element for 3896701 coolant tank heater. 4000W/240V **CSA Approved	3899371S  CUMMINS 3942627 Head Casting
3896702  Coolant Tank Heater 4000W/480V **CSA Approved	3897719  Replacement heating element for 3896702 coolant tank heater. 4000W/480V	3899452S  Used with CC2802 100ft. of 1/4 diameter polyethylene tubing
3896706  Coolant Tank Heater 4000W/480V **CSA Approved	3897720  Replacement heating element for 3896703 coolant tank heater. 2000W/480V **CSA Approved	3901159  Gasket #3901179, Adapter #3901180, thread insert #3901181, heater 3321569S are released in this package.
3896707  Hazardous Location Heater 2500W/120V	3897721  Replacement heating element for 3896710 coolant tank heater. 2500W/120V **CSA Approved	3901457S  Fuel Filter Adapter To Convert FF167 C.A.V. Cartridge to use FS1235 spin-on
3896709  Coolant Tank Heater 1500W/120V **CSA Approved	3897722  Replacement heating element for 3896710 coolant tank heater. 2500W/120V **CSA Approved	3901867S  CUMMINS 3943649 Heater
3896710  Uses service part: 3897725 Coolant Tank Heater 2500W/120V **CSA Approved	3897725  Used with 3896710 Replacement heating element for 3896710 coolant tank heater. 2500W/120V **CSA Approved	3901993S  Used with FF5392 Service gasket for Federal Express fuel filter 3901342
3896711  Uses service part: 3897726 Coolant Tank Heater 2500W/240V **CSA Approved	3902309  Uses service part: 3902309S Fuel filter head	3902309S  Uses service part: 3933978S Used with 3902309, 3917480 Fuel filter head M16 x 1.5 for FF5074 type
3896712  Coolant Tank Heater 4000W/240V	3903853  Hydraulic Filter Head	3903914  CUMMINS 3680963 Oil Pan Heater w/cord 450W/125V
3897183S  Gasket kit containing 1 carton gasket, 1 rubber gasket and washers. In Europe, use with HF6449.		
3897707  Replacement heating element for 3896690 coolant tank heater. 1000W.120V		
3897709  Replacement heating element for 3896692 coolant tank heater. 1500W/120V **CSA Approved		
3897710  Replacement heating element for 3896693 coolant tank heater. 1500W/240V **CSA Approved		





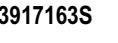

















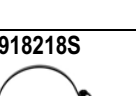















E. PRODUCT GUIDE

3903916  CUMMINS 3688555 1500W/120V Engine Block Heater w/cord. Cummins Signature 600 & ISX	3905074S  SY-KLONE 903K10 Used with AP8405, AP8406 Kit to Install Self-cleaning Precleaner on equipment with 10\"/11\" Intake Size	3910315  Thermostat for use with coolant tank heaters. Includes 4 ft. cord 140-160 degrees Fahrenheit 60 to 71 degrees Celsius (Uses 3910319 Sensing Unit)**CSA Approved
3904378S  Severe Duty Water Filter Head	3905161S  Direct Mount Filter Minder Restriction Gauge	3910316  Sensing unit for use with 3910312 Thermostat 80 to 100 degrees Fahrenheit 27 to 38 degrees Celsius **CSA Approved
3904380  Head used with HF6177, HF7980 Head for HF6177 and HF7980 Bypass Settings : 1,75 bar Inlet/Outlet : 1\"/4 BSP	3905573S  Replacement hinged plastic Cover	3910317  Sensing Unit for use with 3910313 Thermostat 100-120 degrees Fahrenheit 38 to 49 degrees Celsius **CSA Approved
3904554S  Gasket Package	3905830S  Mounting Band w/ 10\" bolt pattern.	3910450S  Used with AP4500 Replacement Bowl
3904837S  SY-KLONE 901K1 Used with AP8403, AP8409 Kit to Install Self-cleaning Precleaner on equipment with 3\"/3.5\"/3.75\" Intake Size	3907161  1/2\" Oil Pan Htr 150W/120V Oil Pan Heater 3825414C without heater cord	3910500S  Used with AP5000 Replacement Bowl
3904838S  SY-KLONE 901K2 Used with AP8403, AP8409 Kit to install Self-cleaning Precleaner on equipment with 4\"/4.5\"/4.75\"/5\" Intake Size	3907721  Remote Mount Head	3910776S  Set of gaskets for LF3355 LF3573 and LF3605 containing 3320125, 3320129 & 3328578
3904839S  SY-KLONE 901K3 Used with AP8403, AP8409 Kit to install Self-cleaning Precleaner on equipment with 5.25\"/5.5\"/6\" Intake Size	3907721S  CUMMINS 3944897 Used with LF3970 Hydraulic Filter Head	3911025S  Remote Mount Filter Minder Air Filter Restriction Gauge (25\" Gauge)
3904840S  SY-KLONE 902K5 Used with AP8404, AP8410 Kit to install Self-cleaning Precleaner on equipment with 5\"/5.25\"/5.5\" Intake Size	3909058S  Mounting Band	3911026S  Remote Mount Filter Minder Air Filter Restriction Gauge (35\" Gauge)
3904841S  SY-KLONE 902K6 Used with AP8404, AP8410 Kit to Install Self-cleaning Precleaner on equipment with 6.25\"/6.5\"/7\" Intake Size	3910200S  Used with AP2000 Replacement Bowl	3911277S  CUMMINS 3944685 Plate
3904842S  SY-KLONE 903K9 Used with AP8410, AP8404 Kit to Install Self-cleaning Precleaner on equipment with 7\"/9\" Intake Size	3910300S  Used with AP3000 Replacement Bowl	3911894S  Head used with FF105 Head Assy.
3905073S  SY-KLONE 902K7 Used with AP8405, AP8406 Kit to Install Self-cleaning Precleaner on equipment with 9\" Intake Size	3910312  Thermostat for use with coolant tank heaters. Includes 4 ft. cord 80 to 100 degrees Fahrenheit 27 to 38 degrees Celsius (Uses 3910316 Sensing Unit)**CSA Approved	3912384S  Used with FS19536, FF5369W, FS1029W Gasket service pack Contains 1 small o'ring for fill cap and 1 large o'ring for bowl.
3905073S  SY-KLONE 902K7 Used with AP8405, AP8406 Kit to Install Self-cleaning Precleaner on equipment with 9\" Intake Size	3910313  Thermostat for use with Coolant tank heaters Includes 4 ft. cord 100-120 degrees Fahrenheit 38 to 49 degrees Celsius Uses 3910317 Sensing Unit**CSA Approved	3912703S  Used with 3915556S, 3915420S O-Ring
3905073S  SY-KLONE 902K7 Used with AP8405, AP8406 Kit to Install Self-cleaning Precleaner on equipment with 9\" Intake Size	3910314  Thermostat for use with coolant tank heaters. Includes 4 ft. cord 120-140 degrees Fahrenheit 49 to 60 degrees Celsius Uses 3910318 Sensing Unit**CSA Approved	3912717S  Head used with FS19512, FS19511, FS19511B

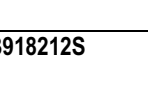





















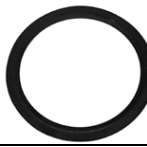

E. PRODUCT GUIDE

3912970	NEW HOLLAND 86512435 Fuel Tank Filter	3915556S	Uses service part: 3912703S Fuel Filter head cap for use with the FS1010.(To bypass the primary fuel filter head on Detroit Diesel engines to replace FF5207/FS19513.)	3917215S	Used with LF3607, MK12059 Gaskets package		
3913023S	Viton Gasket	3915993S	Used with CH44120, CH44115, CH44105, CH44110 Retainer Handle		3917443S	CUMMINS 3303791 Used with 3917445S Spring, Valve.	
3913035S	Viton Gasket		3916004S	Used with CH44115, CH44110 Gasket			
3913038S	Viton Gasket		Overall Height: 0.21 (5) Largest OD: 7.15 (181) Cross Section: Round Largest ID: 6.73 (171)	3917445S	CUMMINS 3841590 Uses service part: 3917443S, 3917445S Used with 3917445S Disc, Valve.		
3913044	Gasket	3916150S	Used with HF28961 Gasket		3917480	Uses service part: 3902309S Replaced by 3934467 Fuel heater kit	
3913045S	Viton Gasket	3916910S	Used with CH44115, CH44120, CH44105, CH44110 Knob, Nut.		3918034S	Used with CC2858, CC2859, CC2861, CC2833, CC2834, CC2823, CC2838, CC2860 Valve/Cutter Kit	
3913057S	Viton Gasket		3916911S	Used with CH44120, CH44115, CH44105, CH44110 Gasket	3918190S	Head used with FF5298 Uses service part: 3933978S	
3913068S	Gasket	3917100S	CUMMINS 3391524 Crankcase Breather Assembly for Cummins Natural Gas Engines		3918193S	OptiAir 5" Weatherhood	
3914240	CUMMINS 3681137 12V Ether Kit	3917101S	CUMMINS 3395123 Crankcase Breather Assembly for Cummins Natural Gas Engines			3918194S	OptiAir 4" Weatherhood
3914692	Head and filter assembly		3917128S	Used with CH44105 Label		3918195S	1.75" Plastic Air Inlet Stack Cap
		3917129S	Used with CH44120 Label			3918196S	Used with AH19087, AH19088, AH19090 6.5" Steel Mounting Band
3914693	Head and filter assembly	3917132S	120V Heater			3918197S	Used with AH19095, AH19096, AH19097, AH19098 8" Steel Mounting Band
		3917160S	Side Drain.		3918198S	Used with AH19085, AH19083, AH19084, AH19086 5.5" Steel Mounting Band	
3914848S	Head used with FS19511, FS19511B, FS19512		3917161S	Used with CH44105 Assy., Bell Housing			
		3917163S	Bottom Drain	3917215	Gaskets package used with LF3607 and MK12059		
3914853	Used with 3928013S Head and Filter Assembly						
							
3915264S	Used with 3915423S Gasket						
3915420S	Uses service part: 3912703S Fuel Filter head cap for use with the FS1010.(To bypass the Secondary fuel filter head on Detroit Diesel engines to replace FF5206.)						
3915423S	Uses service part: 3195264S Fuel Filter head cap for use with the FS1010.(To bypass the fuel filter head on Cummins engines to replace FF105/FS1212/FS1000 or Caterpillar engines to replace FF211/FF5264.)						
							



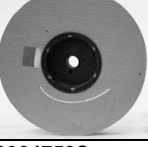













E. PRODUCT GUIDE

3918199S Used with AH19081, AH19082 4" Steel Mounting Band 	3918213S 8" Black Paint Air Inlet Stack Cap 	3918227S Used with AH19067, AH19068 10.3" Mild Steel Mounting Band 
3918200S Used with AH19108 2" Air Inlet Stack Cap 	3918214S 5.5" Chrome Air Inlet Stack Cap 	3918228S 11" Mild Steel Mounting Band 
3918201S Used with AH19109, AH19061, AH19062 2.5" Air Inlet Stack Cap 	3918215S 6" Chrome Air Inlet Stack Cap 	3918229S 11" Stainless Steel Mounting Band 
3918202S Used with AH19064, AH19110, AH19063 3" Air Inlet Stack Cap 	3918216S 7" Chrome Air Inlet Stack Cap 	3918230S Used with AH19080 11.8" Mild Steel Mounting Band 
3918203S Used with AH19065, AH19066 3.7" Air Inlet Stack Cap 	3918217S 8" Chrome Air Inlet Stack Cap 	3918231S Used with AH19069, AH19070 12.1" Mild Steel Mounting Band 
3918204S 4" Air Inlet Stack Cap 	3918218S Used with AH19107 4.4" Mounting Band 	3918232S 13" Mild Steel Mounting Band 
3918205S Used with AH19067, AH19068, AH19069, AH19070 5" Air Inlet Stack Cap 	3918219S Used with AH19108, AH19061, AH19062 5.25" Mild Steel Mounting Band 	3918233S 13" Stainless Steel Mounting Band 
3918206S Used with AH19072 6" Air Inlet Stack Cap 	3918220S Used with AH19063, AH19109, AH19064 6.5" Mild Steel Mounting Band 	3918234S Used with AH19072 14" Mild Steel Mounting Band 
3918207S 6" Plastic-Stainless Air Inlet Stack Cap 	3918221S 7.3" Mild Steel Mounting Band 	3918235S 15" Mild Steel Mounting Band 
3918208S 7" Plastic-Stainless Air Inlet Stack Cap 	3918222S Used with AH19110, AH19065, AH19066 7.9" Mild Steel Mounting Band 	3918236S Used with AH19073, AH19074, AH19036 16" Mild Steel Mounting Band 
3918209S 7" Air Inlet Stack Cap 	3918223S NELSON Q27178 8" Mild Steel Mounting Band 	3918237S Used with AH19075, AH19076 18.1" Mild Steel Mounting Band 
3918210S 5.5" Black Paint Air Inlet Stack Cap 	3918224S Used with AH19078 8.5" Mild Steel Mounting Band 	3918240S SY-KLONE 90RK00 Used with AP8408 Kit to Install Self-cleaning Precleaner on equipment with 2"/2.5"/2.75" Intake Size 
3918211S 6" Black Paint Air Inlet Stack Cap 	3918225S 9" Mild Steel Mounting Band 	
3918212S 7" Black Paint Air Inlet Stack Cap 	3918226S Used with AH19079 10.2" Mild Steel Mounting Band 	















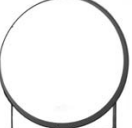

E. PRODUCT GUIDE

3918242S  Used with AH19074 Adapter. To use Precleaner AP8410	3919562 Bilge Boy 7.5 GPM. Coalescer filter element	3926129S Service Part
3918243S  SY-KLONE 80R70 Used with AP8406 8" to 7" reducer for AP8406	3920134 Head used with FS19511, FS19511B, FS19512	3926660S gasket 
3918244S  Used with AH19076 Adapter To use Precleaner AP8405/AP8406	3920138S Used with AP2000 Reducing Sleeve	3926762S  Cummins/Komatsu B 3.3L engine. Used for applications where the engine requires the lube filter to be remote mounted.
3918245S  SY-KLONE 60R50 Self-cleaning pre-cleaner installation kit/reducer. To reduce from 6 inches to 5 inches.	3920175S Used with AP2000 Reducing Adaptor	3926763S  Cummins/Komatsu B 3.3L engine. Perma-Cool 111. Used for applications where the engine requires the lube filter to be remote mounted. Adapts the oil filter landing on the engine block to an oil passage for use with a remote mount lube filter.
3918643  CUMMINS 3607923 Natural Gas	3920913  15.0 GPM Multiple Commercial Style CoalescerT Element	3926764  Cummins/Komatsu B 3.3L engine. 120V, 400W heater. 392676400. Package includes 5 Star #10443 for the frost plug and #11443 for the heater.
3918732S Elbow link for Air Filter restriction gauge	3922052 Fuel Strainer  Overall Height: 4.33 (110) Inlet Connection: .5 Outlet Connection: .5 Largest element OD: 1.91 (48)	3927023S  Uses service part: 3930973S 24 Volt, 300 Watts Heater (Fuel Kit for fuel heater for ISM Options FF2267 and FF2270; replacement heater kit number 393457300.)
3918985S  Used with FS19516, FS19517, FS19525, FS19526, FS19530, FS19531 Dust Cover Gasket for Stanadyne Fuel Managers	3922053 Fuel Strainer  Overall Height: 3.70 (94) Inlet Connection: 7/8-14 Outlet Connection: 7/8-14 Largest element OD: 1.91 (48)	3927719S  Used with FS1291 Replacement Bowl
3919025S  CUMMINS 4920120 Rectangular Gasket for fuel heater for ISM options FF2267 and FF2270; replacement fuel heater kit number 393457300.	3923650S  Anti Drainback Valve	3927776S  ENGINEERING PRODUCTS CO. EW5650100410 Used with 3925199S Filter Minder fuel gauge with T fitting for #8 hose
3919147S  RACOR 21620 Used with FS1281 Replacement bowl	3923820 Fuel Filter Head	3927871S  Filter Wrench for 4.2" OD size elements
3919181 Bilge Boy 7.5 gpm with 115 VAC / 1P / 60Hz	3923925S  Replaces 3323483S Nylon tubing, used for cold weather aids. 150 meters of tubing per carton.	3927995S Used with LF670 Gasket Pack
3919182 Bilge Boy 7.5 gpm with 220 VAC / 1P / 60Hz	3924758S  CUMMINS 3607921 Natural gas element and gasket. Service pack includes element 3924758 and gasket 3924757.	3928013S  Uses service part: 3914853 Used with 3847102S, 3889183S, 3894689S, 3962763 Heater Kit
3919184 Bilge Boy 2.5 gpm with 115 VAC / 1P / 60Hz	3925199S  Uses service part: 3927776S Fuel Filter Restriction Gauge (Includes fitting for direct mount-1/8-27 NPT Thds)	
3919185 Bilge Boy 2.5 gpm with 220 VAC / 1P / 60Hz		
3919515  Fuel Coalescer		









E. PRODUCT GUIDE

3928341  Cummins ISB & QSB (750 W/120V) Coolant Heater	3931308S Used with LF3730 Gaskets kit including 2 O'Ring gaskets 393131000 & 393131100, 1 gasket 393131300 and 1 washer 393131200 for SCANIA 4 series trucks. To be used with LF3730	3933350  Clamp
3928342  Cummins ISX & Signature Series (1500W/120V) Coolant Heater	3931657 Gasket: 3320128 (1), 3328464(1), 3931312 (1), 3931313(1) Kit containing FS19584 + head (incl. prime pump) + WIF (with sidewise outlet connection closed).	3933711S  25° Minder Gauge 1/8 male to male fitting
3928544S Used with FS19584 WIF Sensor	3931658 100,000 service interval filter used in LF9009 applications	3933746S  20° Minder Gauge 1/8 male to male fitting
3929113 Kit containing a Blind plate 3929124 + a gasket 3328464 for LF 777 Head	3931659 Lube Filter 100,000 service interval filter used in LF9667 applications	3933978S Used with 3892646S, 3918190S, 3902309S, 3944660S Plug M14x1.5 and washer
3929251S Used with HF6718, HF6733, HH6951, HH6955, HH6960, HH6961, FS1285 Overall Height: 0.19 (5) Largest OD: 4.98 (126) Cross Section: Rectangular Largest ID: 4.42 (112)	3931660 Lube Filter 100,000 service interval filter used in LF9691A applications	3934206S  Restriction Indicator
3929260 Kit containing an FS19584 + HEAD (incl. prime pump) + PTC+WIF (sidewise outlet connection on head is closed)	3931661 Lube Filter 100,000 service interval filter used in LF9620 applications	3934299 Uses service part: 3934304S PTC heater kit 24 volt
3929722S  Filter minder gauge	3931662 Lube Filter 100,000 service interval filter used in LF9000 applications 3931663 Lube Filter 100,000 service interval filter used in LF9001 applications	3934300S CUMMINS 4920119 Thread Adaptor Insert for fuel heater for ISM options FF2267 and FF2270; replacement fuel heater kit 393457300.
3930200S  Reducer	3932494S  Cover Assembly	3934304S Used with 3934299, 3934467, 3934572, 3934573 Electrical cable for PTC heater kits : 3934299, 3934467, 3934572, 3934573
3930225S  Reducer	3932495S  Metal mounting bracket	3934467  Uses service part: 3934304S Replaces 3917480 PTC heater kit - 24 V - Replaces 3917480 & 3321732S
3930250S  Reducer	3932939 Kit containing Pre-filter FS19584 + head (incl. prime pump) + PTC + WIF (outlet connection at top of head is closed)	3934469S  CUMMINS 4920118 Aluminum Adapter for Cummins fuel heater kit for ISM options FF2267 and FF2270; replacement fuel heater kit number 393457300.
3930618S  Head used with FF105, FS1212, FS1000 Gasket: 255622 (1)	3933037S CHRYSLER 5093122AA Fuel Water Separator Housing	3934572 Uses service part: 3934304S PTC heater kit - 24 volts - Replacing the 3923883
3930708S  Used with CC2806 Daylight plate	3933191  Fuel Filter Head	3934573 Uses service part: 3934304S Fuel Heater kit - 24 V for ISM options FF2267 and FF2270.
3930885 Head and Filter Assembly	3933191S Fuel Head for Fuel Island Filtration.	
3930939 T-connector for ether valve & cylinder.	3933344S Gasket	

























E. PRODUCT GUIDE

<p>3934665 1500 Watt/120 Volt Caterpillar engines C10, C12, 3196, 3176, 1999 and newer. Replaces the 1" NPT plug in rear of oil cooler Caterpillar 3406 (with Brake Saver 1994 and newer) replaces 1" plug in oil cooler, front bonnet. This heater is not for use with 1998 3406E or 15.8L 600 HP models.</p> 	<p>3935743S ENGINEERING PRODUCTS CO. EY5650301410 Fuel Minder Gauge and fitting #10 hose. Has a diaphragm with cloth backing that allows the gauge to operate under higher vacuum. This diaphragm will allow this gauge to be used on all Cummins, Caterpillar, and Detroit Diesel engines</p> 	<p>3938161S Thread Adapter Insert</p> 
<p>3934841S SCANIA 392654 Used with LF16228 Gasket</p>	<p>3936328 Urea Tote</p>	<p>3938173S Uses service part: 3940777S FS20000 Lubricity Enhancing Filter & Head assembly</p> 
<p>3935185S For Upgrade, use 3958484S O-Ring</p>  <p>Overall Height: 0.14 (4) Largest OD: 2.76 (70) Cross Section: Round Largest ID: 2.48 (63)</p>	<p>3936434 Head and filter assembly</p>	<p>3938495S Mounting</p>
<p>3935261S Used with CH41100 Housing Assembly</p>	<p>3936434S FWS Housing</p>	<p>3938835S WIF</p>
<p>3935262S Used with CH41100, CH41101, CH41102 Base and Shaft Assembly</p>	<p>3936445S Used with AH19273, AH19274 Used on 13" plastic air cleaner</p> 	<p>3938954 Strainer</p>
<p>3935293S Used with CH41100 Housing Assembly</p>	<p>3936509S CUMMINS 3321617 Fuel Heater Kit includes wiring harness</p> 	<p>3939391S Breather</p>
<p>3935421S Used with AH19257 Cover Assembly</p> 	<p>3936963 Oil Fill Cap for Centrifuge Products</p> 	<p>3939392S Dip Stick Port Boss Adaptor for all Cummins M11 & ISM11 engines.</p>
<p>3935422S Used with AH19266 Cover Assembly</p> 	<p>3937557S Power Steering Filter Nelson 879014F</p>  <p>Overall Height: 2.73 (69) Overall OD: 3.38 (86) End 1 ID: 2.00 (51)</p>	<p>3939393S O-ring Assembly</p>
<p>3935607 Head and Filter Assembly Cummins 3959608</p> 	<p>3937616S Fuel/water separator housing assembly</p> <p>Width: 7.34 (186)</p>	<p>3939396S SY-KLONE 40R35 A flanged insert for the installation of Self-cleaning precleaners.</p>
<p>3935621 Head and Filter Assembly</p> 	<p>3937860 CUMMINS 3966139 Head used with FS19608</p> 	<p>3939397S SY-KLONE 40R375 A flanged insert for the installation of Self-cleaning precleaners.</p> 
<p>3935659 Tank Heater Heating Element</p>	<p>3937862 CUMMINS 3966140 Head and Filter Assembly (Uses FS19616 Element)</p> 	<p>3939399S SY-KLONE 50R45 A flanged insert for the installation of Self-cleaning precleaners.</p>
<p>3935662 Tank Heater Heating Element</p> 	<p>3938140S Mounting Bracket</p> 	<p>3939401S SY-KLONE 60R525 A flanged insert for the installation of Self-cleaning precleaners.</p>





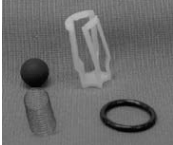











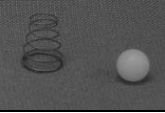

E. PRODUCT GUIDE

3939413S  An expansion plug that permits the installation of Sy-Klone precleaners.	3940921S CUMMINS POWER GENERATION LTD 140337302	3941470 CUMMINS POWER GENERATION LTD 9507
3939417S SY-KLONE 9003WMESHKIT A screen that permits the installation of Self-cleaning precleaners.	3940922S CUMMINS POWER GENERATION LTD 140336102	3941472 CUMMINS POWER GENERATION LTD 9631
3939418S SY-KLONE 9003SCKIT A screen that permits the installation of Self-cleaning precleaners. 	3940923S CUMMINS POWER GENERATION LTD 9639	3941519S Used with CH41114, CH41112, CH41101 Fitting
3939419S SY-KLONE 9002WMESHKIT A screen that permits the installation of Self-cleaning precleaners.	3940924S 45 Degree Elbow	3941580 CUMMINS POWER GENERATION LTD 9569
3939421S SY-KLONE 9001WMESHKIT A screen that permits the installation of Self-cleaning precleaners.	3940925S CUMMINS POWER GENERATION LTD 140336202	3941638 CUMMINS POWER GENERATION LTD 179299903
3939441S Breather	3940926S CUMMINS POWER GENERATION LTD AAH770068	3941642 CUMMINS POWER GENERATION LTD 9499
3939442S Breather Service Kit	3940927S CUMMINS POWER GENERATION LTD NX2NSM11	3941717  HYUNDAI 11N84320616 24V heater kit
3939443S Hose	3940929S CUMMINS POWER GENERATION LTD 5031485	3941964 CUMMINS POWER GENERATION LTD 9506
3939461S Fitting	3940930S CUMMINS POWER GENERATION LTD 140335802	3942439 CUMMINS POWER GENERATION LTD 179299904
3940104S CATERPILLAR 4M0189 Used with FF5323, FF5337 O-ring gasket	3940931S CUMMINS POWER GENERATION LTD 140335602	3942473 CUMMINS POWER GENERATION LTD 9512
3940105S CATERPILLAR 6V3907 Used with LF3485 O-ring gasket	3940946S CUMMINS POWER GENERATION LTD 1403370 Rain Cap	3942821 Heater Kit
3940108 FIVE STAR MFG. 36203 Diesel Fuel Warmer 	3940947S CUMMINS POWER GENERATION LTD 140335502	3942834S Insert 
3940356S 10" Rain Cap 	3940949S CUMMINS POWER GENERATION LTD 140335402	3942835S Service Parts
3940357S 8" Rain Cap 	3941120 Switch Assembly	3942964 CUMMINS POWER GENERATION LTD 5410600
3940374S Service element for the Davco Fuel Pro 382, DDC Series 60 Engine	3941157 Head used with AF26113 Cummins ISX & ISM Engines 	3943020 CUMMINS POWER GENERATION LTD 5410601
3940750S Used with CH41101, CH41102, CH41112 Base and Shaft	3941433 CUMMINS POWER GENERATION LTD 5410602	3943022 CUMMINS POWER GENERATION LTD 54161401
3940756S Used with CH41101, CH41102, CH41112 Housing Assembly	3941461 CUMMINS POWER GENERATION LTD 5410604	3943039 CUMMINS POWER GENERATION LTD 54161402
3940831S WIF Sensor	3941463 CUMMINS POWER GENERATION LTD 5410606	3943071S Used with CH41114, CH41112, CH41101 Plunger Assembly
3940920S CUMMINS POWER GENERATION LTD 140336002	3941466 CUMMINS POWER GENERATION LTD 5410603	3943160S For engine applications with dual breathers, both an Enviroguard System Kit and Dual Breather Kit are required for installation. 
	3941468 CUMMINS POWER GENERATION LTD 9508	3943871S Used with CH41111, CH41112, CH41113, CH41114 Top Shaft















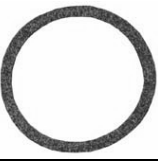













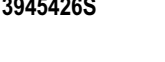

E. PRODUCT GUIDE

3943939	CUMMINS POWER GENERATION LTD 541084601	394443S	DAVCO 380040 Body Housing for Diesel Pro and Fuel Pro	3944458S	DAVCO 232007 Replaces 3945149S Wrench Collar for Diesel Pro and Fuel Pro
3943941S	Special Tubing				
3943942S	Special Tubing			3944459S	DAVCO 232008 O-rings for Diesel Pro and Fuel Pro
3943943S	Special Tubing				
3943944S	Special Tubing	3944445S	DAVCO 380042 Collar for Diesel Pro and Fuel Pro	3944460S	DAVCO 232002 Wrench Collar for Diesel Pro and Fuel Pro
3943945S	Special Tubing				
3943946S	Special Tubing	3944447S	DAVCO 101132 Check Valve Kit for Diesel Pro and Fuel Pro	39444520S	Housing used with CH41102
3943947S	Special Tubing			39444660S	Uses service part: 3933978S Head
3944204S	Clamp			3944666S	DAVCO 333041 WIF Connector Module for Diesel Pro and Fuel Pro
3944205S	CUMMINS POWER GENERATION LTD 503187011	3944448S	DAVCO 380134 Metal Collar Wrench for Diesel Pro and Fuel Pro	3944694	TENNANT 55850 Replaces 91645A, 91783A
3944206S	CUMMINS POWER GENERATION LTD 503187014				
3944223S	CUMMINS 4917446 Valve Piston Kit	3944449S	DAVCO 380072 O-rings for Diesel Pro and Fuel Pro	3944697	Head and Filter Assembly
					
3944287S	Head used with FS20022, FS19732 Head with Priming Pump	3944450S	DAVCO 102166 Fuel Heater Assembly for Diesel Pro and Fuel Pro	3944795S	Fuel Filter Head
					
3944440S	DAVCO 380043 Vent Cap & Assembly for Diesel Pro and Fuel Pro	3944451S	DAVCO 382002 Composite Collar Wrench for Diesel Pro and Fuel Pro	3944904S	45 Degree Elbow
				3945052S	Head Pack
3944441S	DAVCO 380056 Holddown Spring for Diesel Pro and Fuel Pro	3944452S	DAVCO 93035 Check Valve for Diesel Pro and Fuel Pro	3945059S	Used with FH23302, FH23303, FH23304, FH23200, FH23201, FH23202 Collar
					
3944442S	DAVCO 101994 O-ring Gasket for Diesel Pro and Fuel Pro	3944453S	DAVCO 102008 Check Valve for Diesel Pro and Fuel Pro	3945060S	Used with FH23302, FH23303, FH23304 Cover Assembly
				3945061S	Used with FH23302, FH23303, FH23304, FH23200, FH23201, FH23202 O-ring set - vent cap to cover and cover to body
		3944454S	DAVCO 90037 Fitting & O-ring for Diesel Pro and Fuel Pro	3945062S	Used with FH23302, FH23303, FH23304, FH23200, FH23201, FH23202 Check valve service kit
					
		3944455S	DAVCO 102408 Harness Kit for Diesel Pro and Fuel Pro		
					
		3944456S	DAVCO 102176 Heater Kit for Diesel Pro and Fuel Pro		
					

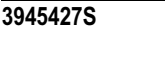
E. PRODUCT GUIDE

3945063S  Used with FH23302, FH23303, FH23304, FH23200, FH23201, FH23202 Drain valve	3945136S  DAVCO 102168 Used with 3952119S Diesel Pro and Fuel Pro Unit Fuel Heater Assembly	3945160S DAVCO 101440 Heater Wire Harness for Davco Fuel Pro and Diesel Pro Units
3945064S  Thermostat Assembly	3945137S DAVCO L4057 Diesel Pro and Fuel Pro Unit Decal Label	3945163S DAVCO 102097 Heater Wire Harness for Davco Fuel Pro and Diesel Pro Units
3945065S  Thermostat Assembly	3945140S  DAVCO 382029SVCB Diesel Pro and Fuel Pro Unit Mounting Plate	3945164S DAVCO 101707 O-ring for Davco Fuel Pro and Diesel Pro Units
3945120S  DAVCO 102455 Used with 3952119S Diesel Pro and Fuel Pro Unit Heater Wire Harness	3945141S Diesel Pro and Fuel Pro Unit Stud	3945182S  DAVCO 101480 Diverter Cap for Davco Fuel Pro and Diesel Pro Units. 1"-14
3945121S DAVCO 102145 Diesel Pro and Fuel Pro Unit Fuel Heater Assembly	3945144S DAVCO 102271 Diesel Pro and Fuel Pro Unit Housing Bracket	3945183S  DAVCO 101589 Diverter Cap for Davco Fuel Pro and Diesel Pro Units. 1"-14 x4
3945123S  DAVCO 102220 Used with 3952119S Diesel Pro and Fuel Pro Unit Heater Wire Harness	3945145S DAVCO 102376 Diesel Pro and Fuel Pro Unit Heater Wire Harness	3945184S  DAVCO 102226 Diverter Cap for Davco Fuel Pro and Diesel Pro Units. M16 x 1.5
3945124S DAVCO 102412 Diesel Pro and Fuel Pro Unit Harness Kit	3945146S DAVCO 101017 Sensor for Davco Fuel Pro and Diesel Pro Units	3945185S  DAVCO 101466 Diverter Cap for Davco Fuel Pro and Diesel Pro Units. 3/4"-16
3945125S Diesel Pro and Fuel Pro Unit Service package	3945147S  DAVCO 101312 Maintenance Kit for Davco Fuel Pro and Diesel Pro Units	3945186S  DAVCO 101492 Diverter Cap for Davco Fuel Pro and Diesel Pro Units. 7/8"-14
3945126S  DAVCO 101868 Diesel Pro and Fuel Pro Unit Heater Cord	3945148S  DAVCO 232010, DAVCO 320620 Body Housing for Davco Fuel Pro and Diesel Pro Units	3945187S  DAVCO 101721 Diverter Cap for Davco Fuel Pro and Diesel Pro Units. M18-1.5
3945127S DAVCO 102456 Diesel Pro and Fuel Pro Unit Heater Wire Harness	3945153S  DAVCO 101814 Fuel Heater Assembly for Davco Fuel Pro and Diesel Pro Units	3945188S  DAVCO 101492 Diverter Cap for Davco Fuel Pro and Diesel Pro Units. 7/8"-14
3945128S DAVCO 101966 Diesel Pro and Fuel Pro Unit Service Package	3945154S DAVCO 101439 WIF Wire Harness for Davco Fuel Pro and Diesel Pro Units	3945189S  DAVCO 101570 Diverter Cap for Davco Fuel Pro and Diesel Pro Units. M16 x 1.5 with 2 Studs
3945129S DAVCO 102359 Diesel Pro and Fuel Pro Unit Heater Wire Harness	3945155S DAVCO 101815 WIF Wire Harness for Davco Fuel Pro and Diesel Pro Units	3945190S DAVCO 102436 Diesel Pro and Fuel Pro Unit Heater Wire Harness
3945130S  DAVCO 101923 Diesel Pro and Fuel Pro Unit Stud	3945156S DAVCO 100457 Heater Wire Harness for Davco Fuel Pro and Diesel Pro Units	3945191S DAVCO 102437 Diesel Pro and Fuel Pro Unit Heater Wire Harness
3945131S DAVCO 380638 Diesel Pro and Fuel Pro Unit Body Housing	3945157S DAVCO 102445 WIF Wire Harness for Davco Fuel Pro and Diesel Pro Units	
3945133S DAVCO 102414 Diesel Pro and Fuel Pro Unit WIF Wire Harness	3945158S DAVCO 100278 Heater Wire Harness for Davco Fuel Pro and Diesel Pro Units	
3945134S DAVCO L4084 Diesel Pro and Fuel Pro Unit Decal Label	3945159S DAVCO 230068 Heater Kit for Davco Fuel Pro and Diesel Pro Units	

E. PRODUCT GUIDE

3945207S  DAVCO 560016 Replacement Glass Window for REN Product	3945343 CUMMINS POWER GENERATION LTD 541100302	3945563S  DAVCO 560026 Regulator to Mounting Plate Gasket- REN product
3945208S  DAVCO 560021 Inlet Sediment Bowl Screen for REN product	3945358S CUMMINS POWER GENERATION LTD 140340703	3945565S  DAVCO 57013370 1-Piece Isoplast Front Window Kit- REN product
3945209S  DAVCO 560028 Plexiglas Front Window Gasket (2 Required)-REN product	3945359S CUMMINS POWER GENERATION LTD 140352703	3945567S  DAVCO 560027 Valve Base Gasket- REN product
3945210S  DAVCO 560030 Inlet Sediment Bowl Gasket-REN product	3945360S CUMMINS POWER GENERATION LTD 140340801	3945568S  DAVCO 560029 Glass Front Window Gasket (2 Required)-REN product
3945211S  DAVCO 560340 REN product gasket	3945367S Special Tubing	3945569S  DAVCO 560031 Screw- REN product
3945215S REN gasket	3945375S Reducer 	3945570S  DAVCO 560032 Screw- REN product
3945217S  DAVCO 57013343 REN Regulator Gasket	3945376 CUMMINS POWER GENERATION LTD 541100301	3945572S  DAVCO 560199 Fitting- REN Product
3945218S  DAVCO 57013348 REN Valve Without Float	3945400S Reducer 	3945573S  DAVCO 560331 REN Product
3945219S  DAVCO 57023342 REN Float Assembly	3945404 CUMMINS POWER GENERATION LTD 541100303	3945581S  DAVCO 571303 Pressure Regulator Meter Kit- REN
3945220S  DAVCO 57023343 REN Meter Gasket Kit	3945425S  DAVCO 102517 Installation Kit for Davco Fuel Pro and Diesel Pro Units. LED Installation (WIF)	3945630S  DAVCO 103033 Thermo Switch- REN
3945222S  DAVCO 5710032601 Conversion Kit MRA to MRA-E with Cover (remote applications)	3945426S  DAVCO 102491 Installation Kit for Davco Fuel Pro and Diesel Pro Units	3945821  INGERSOLL-RAND 57047300 Starter Kit, same as 259371 without Indicator Switch
3945300S  Reducer	3945427S  DAVCO 102492 Installation Kit for Davco Fuel Pro and Diesel Pro Units	3945852S  DAVCO 560394 Counter Cover Gasket- REN Product
	3945498 CUMMINS POWER GENERATION LTD 5410846	3945960S  DAVCO 910016 REN Manifold Kit
	3945541S Head and Insert Pack 	
	3945560S  DAVCO 560100 Hose Nipples (4 required)- REN Product	
	3945561S  DAVCO 57311606 Sight Gauge Install Kit (inserts & ferrules)- REN Product	
	3945562S  DAVCO 57013334 Safety Cut-off Kit- REN Product	

E. PRODUCT GUIDE

3946045	CUMMINS POWER GENERATION LTD 5411111	3946090S	SY-KLONE 9002SC Screen	3946107S	Adaptor
3946047	CUMMINS POWER GENERATION LTD 5411112			3946108S	SY-KLONE 68013 Adaptor
3946049S	SY-KLONE 901K4 Self-cleaning precleaner adaptor package	3946091S	SY-KLONE 9001SC Screen	3946109S	Adaptor
3946050S	SY-KLONE 901K16 Self-cleaning precleaner adaptor package	3946092S	SY-KLONE 70RA625 Adaptor		
		3946093S	SY-KLONE 70R65 Flanged Insert	3946110S	SY-KLONE 64060 Adaptor
3946051S	SY-KLONE 902K13 Self-cleaning precleaner adaptor package	3946094S	SY-KLONE 70R625 Flanged insert		
		3946095S	SY-KLONE 70R60 Flanged insert	3946111S	SY-KLONE SYK20015 Adaptor Kit
3946053S	SY-KLONE 902K15 Self-cleaning precleaner adaptor package			3946112S	SY-KLONE 9001SCKIT Screen
3946054S	Reducer	3946097S	SY-KLONE 50R40 Flanged insert		
3946055S	SY-KLONE 902K8 Self-cleaning precleaner adaptor package			3946248S	Fuel Filter Head
3946056S	SY-KLONE 903K14 Self-cleaning precleaner adaptor package	3946098S	SY-KLONE 45RA425 Flanged insert		
		3946099S	SY-KLONE 40R323 Flanged insert	3946273S	Restriction Indicator
3946057S	SY-KLONE 903K17 Self-cleaning precleaner adaptor package				
3946058S	SY-KLONE 904K20 Self-cleaning precleaner adaptor package	3946100S	SY-KLONE 40R30 Flanged insert	3946322S	OptiAir 6" Weatherhood
3946080S	Expansion Plug				
3946084S	SY-KLONE DB18008 Dust seal	3946101S	SY-KLONE 40R275 Flanged insert	3946323S	Restriction Indicator
3946085S	SY-KLONE DB12004 Dust seal			3946324S	Restriction Indicator
3946086S	SY-KLONE DB11007 Dust seal	3946102S	SY-KLONE 40R25 Flanged insert		
3946087S	SY-KLONE DB11006 Dust seal			3946326S	Restriction Indicator
		3946103S	Flanged insert		
3946088S	Flanged insert	3946104S	Flanged insert	3946327S	Restriction Indicator
		3946105S	SY-KLONE 80012 Adaptor		
3946089S	SY-KLONE 9003SC Screen				
		3946106S	SY-KLONE 78016 Adaptor		
					











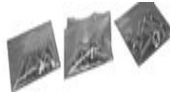

E. PRODUCT GUIDE

3946328S  Restriction Indicator	3946458S  OptiAir 8" Weatherhood	3946668S  DAVCO 382023 Wire Display Rack for Diesel Pro and Fuel Pro
3946329S  Restriction Indicator	3946459S  Used with AH19474, AH19485, AH19496, AH19484 OptiAir 4" Cover Assembly Kit	3946670S  DAVCO 103041 LED WIF Assembly Light for Diesel Pro and Fuel Pro
3946330S Restriction Indicator	3946460S  Used with AH19483, AH19487, AH19482, AH19486 OptiAir 5" Cover Assembly Kit	3946673S  DAVCO 102454 Used with 3952119S Thermostat Switch for Diesel Pro and Fuel Pro
3946331S Restriction Indicator	3946461S  Used with AH19476, AH19477, AH19489, AH19488 OptiAir 6" Cover Assembly Kit	3946677S  DAVCO 382027SVCB Mounting Plate for Diesel Pro and Fuel Pro
3946332S Restriction Indicator	3946462S  Used with AH19261, AH19260, AH19491, AH19490 OptiAir 8" Cover Assembly Kit	3946704S  DAVCO 102146 Hex Head Bolt for Diesel Pro and Fuel Pro
3946369 CUMMINS POWER GENERATION LTD 32859600	3946463S  Used with AH19478, AH19479 OptiAir 10" Cover Assembly Kit	3946705S  DAVCO 102420 Housing Cover for the Fuel Pro and Diesel Pro Units
3946379S CUMMINS POWER GENERATION LTD 140340702	3946464S  OptiAir 10" Weatherhood	3946706S  DAVCO 102425 Collar for the Fuel Pro and Diesel Pro Units
3946385 Electric Valve	3946465S  Used with AH19333, AH19334 OptiAir 11" Cover Assembly Kit	3946707S  DAVCO 102463 Fuel Heater Assembly for Diesel Pro and Fuel Pro
3946389S DAVCO 570811 Used with RN24015 Universal Mounting Bracket for the 15 Gallon (56.8 liter) Oil Supply Reservoir and Stand.	3946466S  OptiAir 11" Weatherhood	3946708S  DAVCO 102464 Fuel Heater Assembly for Diesel Pro and Fuel Pro
3946390S DAVCO 570812 Used with RN24017 Universal Mounting Bracket for the 30 Gallon (113.6 liter) Oil Supply Reservoir and Stand.	3946467S  Used with AH19480, AH19481 OptiAir 13" Cover Assembly Kit	3946711S  DAVCO 910007 Fitting and O-ring for Diesel Pro and Fuel Pro
3946411S CUMMINS 4937489 Used with FS19511N Bowl Assembly	3946468S  OptiAir 13" Weatherhood	3946712S  DAVCO 910009 Fitting for Diesel Pro and Fuel Pro
3946447  Head and Switch Assembly	3946512S DAVCO 57020525 LCD Readout for Diesel Pro and Fuel Pro	3946714S DAVCO 102493 Installation Kit for Diesel Pro and Fuel Pro
3946456S  OptiAir 10" Metal Bracket Assembly	3946662S DAVCO 100311 Wiring Harness for Diesel Pro and Fuel Pro	3946715S DAVCO 101798 Heater Hose for Diesel Pro and Fuel Pro
3946457S  OptiAir Dust Ejection Valve	3946667S DAVCO 102424 Conversion Kit for Diesel Pro and Fuel Pro	



E. PRODUCT GUIDE

3946716S  DAVCO 102015 Electric Cord for Diesel Pro and Fuel Pro	3947034S  Fuel Filter Head	3948239S  Used with FF5421 Gasket is used as a thread seal Overall Height: 0.08 (2) Largest OD: 1.30 (33) Cross Section: Rectangular Largest ID: 0.78 (20)
3946905S  DAVCO 20909 Plug for REN Product	3947114S  DAVCO 101935 Diesel Pro and Fuel Pro Unit Valve Assembly	3948395S  RACOR RK211131311 Used with FS19532, FS19753, FS19736, FS19551, FS19687, FS1287, FS19734 Replacement Bowl
3946906S  DAVCO 57103352 Maintenance Kit for REN Product	3947136S  CUMMINS 4928763 Thread Adaptor Insert	3948495S Special Tubing
3946907S Plug for REN Product	3947145  Hydraulic Filter Head	3948496S Service Part- Bracket
3946908S  DAVCO 560092 Mounting Plate for REN Product	3947315S  DAVCO 102536 Upgrade Kits for the Fuel Pro Units. Contains a 7 micron plus size filter, cover, and a collar to install a standard or plus size filter element.	3948497S Service Part- Bracket
3946909S  DAVCO 560099 Regulator Bracket for REN Product	3947337S  DAVCO 102537 Upgrade Kits for the Fuel Pro Units. Contains a 25 micron plus size filter, cover, and a collar to install a standard or plus size filter element.	3948504 CUMMINS POWER GENERATION LTD 1403756
3946910S  DAVCO 571302 Assembly Valve for REN Product	3947502S  DAVCO 920002 Mounting Plate for Davco Industrial Pro Units	3948505 CUMMINS POWER GENERATION LTD 1403757
3946911S  DAVCO 57013349 Screw for REN Product	3947503S  DAVCO 920003 Housing Bracket for Industrial Pro Unit	3948558S Service Part
3946951S  Used with FS19624 O-Ring	3947504S  DAVCO 101423 Fitting for Davco Industrial Pro Units	3948644S  DAVCO 560019 REN Flange Ring
3946989S  CUMMINS 4924295 Fuel Tube Kit	3947505S  DAVCO 101424 Fitting for Davco Industrial Pro Unit	3948645S  DAVCO 560311 REN Gasket
3946990S  CUMMINS 4924296 Fuel Tube Kit	3947508S  CUMMINS 4924702 Kit containing one fuel tube (short, inlet)	3948665 CUMMINS POWER GENERATION LTD 1403825
3946991S  CUMMINS 4924297 Vibration Isolator Kit	3947509S  CUMMINS 4924703 Kit containing one fuel tube (long, outlet)	3948667 CUMMINS POWER GENERATION LTD 1403827
3946993S  CUMMINS 4924298 Drain Plug & Oring Kit	3947658S Used with AK15 Hump Hose	3948669S Clamp
3946995S  CUMMINS 4924192 Electrical Fuel Pump Kit	3947659S Used with AK14 Hump Hose	3948670S Clamp
3946996S Electric Fuel Pump Kit	3948196  CUMMINS POWER GENERATION LTD 541060201	3948671S Clamp
	3948198S Special Tubing	3948672S Clamp
		3948673S Clamp
		3948674S Clamp
		3948675S Clamp
		3948676S CUMMINS POWER GENERATION LTD 503187104

E. PRODUCT GUIDE

3948714S	CUMMINS 4917751		3949066S	OptiAir 700 Series Bracket		3950140	CUMMINS POWER GENERATION LTD 541119303
3948731S	Reducer		3949067S	Restriction Indicator		3950253	Filter Cart
3948732S	CUMMINS 4097964					3950311	CUMMINS POWER GENERATION LTD 541119302
3948733S	CUMMINS 4924392					3950365S	Dual Fuel Head for Fuel Island Filtration.
3948734S	CUMMINS 4924394					3950385S	DAVCO 57023549 REN Slow Flow Meter Screw
3948735S	CUMMINS 4924396		3949127	CUMMINS 4925089			
3948736S	CUMMINS 4924398		3949134S	CUMMINS 4917962		3950386S	DAVCO 560017 REN Flange Ring
3948737S	CUMMINS 4924381		3949135S	CUMMINS 4917963			
3948738S	CUMMINS 4924391		3949136S	CUMMINS 4917729		3950387S	DAVCO 560020 REN Metal Bowl
3948739S	CUMMINS 4924405		3949137S	CUMMINS 4917730			
3948740S	CUMMINS 4924406		3949138S	CUMMINS 4917723			
3948741S	CUMMINS 4098638		3949139S	CUMMINS 4917722			
3948752	CUMMINS POWER GENERATION LTD 4925124		3949140S	CUMMINS 4917721			
3948764S	DAVCO 57013564 REN Safety Cut-Off Switch		3949141S	CUMMINS 4917720		3950388S	DAVCO 560310 REN Endplate
3948951S	CUMMINS POWER GENERATION LTD 1403860		3949148S	CUMMINS 4917724			
3948952	CUMMINS POWER GENERATION LTD 5411113		3949149S	CUMMINS 4917706		3950389S	DAVCO 560319 REN Spring
3948963	CUMMINS POWER GENERATION LTD 5411150		3949163S	DAVCO 102005 Wire Rack which will hold Diesel Pro 232 and Diesel Pro 233.			
3948967	CUMMINS POWER GENERATION LTD 5411151		3949165S	Non-Operational Fuel Pro Unit		3950390S	DAVCO 560324 REN Spring
3948978S	Service Kit for FH21010B4		3949166S	Non-Operational Diesel Pro Unit			
3949015S	Weatherhood for 6" ID Inlet OptiAir Systems		3949293	CUMMINS POWER GENERATION LTD 5411194		3950391S	DAVCO 560326 REN O-ring
			3949411	CUMMINS 4925090			
			3949848S	Brace		3950392S	DAVCO 560355 REN Gasket
			3949851S	CUMMINS 4917718			
			3949853S	CUMMINS 4917719			
			3949855S	CUMMINS 4917717			
			3949871S	CUMMINS 4917716			

E. PRODUCT GUIDE

<p>3950393S DAVCO 560365 REN C Spring</p> 	<p>3950450S Reducer</p> <hr/> <p>3950491 CUMMINS POWER GENERATION LTD 5411203</p> <hr/> <p>3950600S Used with AP5000 Expansion Adaptor FOR AP0500</p> <hr/> <p>3950622S Threaded insert with loctite kit</p> 	<p>3950887 CUMMINS POWER GENERATION LTD 179354401</p> <hr/> <p>3950889 CUMMINS POWER GENERATION LTD 179354501</p> <hr/> <p>3950891 CUMMINS POWER GENERATION LTD 179354502</p> <hr/> <p>3950893 CUMMINS POWER GENERATION LTD 179354503</p> <hr/> <p>3950895 CUMMINS POWER GENERATION LTD 179354601</p> <hr/> <p>3950897 CUMMINS POWER GENERATION LTD 179354602</p>
<p>3950394S DAVCO 560371 REN Ratchet Wheel</p> 	<p>3950689S Used with CH41111, CH41113 Base and Shaft</p> <hr/> <p>3950690S Used with CH41114, CH41112 Base and Shaft</p>	<p>3950899 CUMMINS POWER GENERATION LTD 541108601</p> 
<p>3950395S DAVCO 560389 REN Gasket</p> 	<p>3950729S DAVCO 102600 Replaces 3945151S WIF Harness for Diesel Pro Fuel Housing</p> <hr/> <p>3950786S CUMMINS POWER GENERATION LTD 1403552</p>	<p>3950899 CUMMINS POWER GENERATION LTD 541108601</p> 
<p>3950396S DAVCO 560393 REN Meter Counter Cover</p> 	<p>3950787S CUMMINS POWER GENERATION LTD 1403601</p> <hr/> <p>3950789S Special Tubing</p>	<p>3950911S Rubber Accessories</p> <hr/> <p>3951006S Head and Filter Assembly</p>
<p>3950397S DAVCO 57020326 REN LCD Meter Readout</p> 	<p>3950790S Special Tubing</p> <hr/> <p>3950792S CUMMINS POWER GENERATION LTD 1403551</p>	<p>3951024 CUMMINS POWER GENERATION LTD 541119301</p> <hr/> <p>3951083S Restriction Indicator</p> 
<p>3950400S Reducer</p>	<p>3950794S CUMMINS POWER GENERATION LTD 1403605</p> <hr/> <p>3950817 CUMMINS POWER GENERATION LTD 179354201</p>	<p>3951084S Remount Mounting Kit</p> 
<p>3950444S Used with FH23200, FH23201, FH23202, FH23209M, FH23210M, FH23211M, FH23302, FH23303, FH23304, FH23308, FH23315M, FH23316M, FH23317M, FH23321 Gasket package for Diesel Pro FH232 and FH233 Series. Consists of 3952163, 3952164, and 3952165.</p> 	<p>3950827S CUMMINS POWER GENERATION LTD 1403555</p> <hr/> <p>3950828S CUMMINS POWER GENERATION LTD 5032466</p> <hr/> <p>3950855S Flexible hose</p>	<p>3951133 Fuel Reservoir Cummins ISB</p> <p>Overall Height: 5.58 (142) Largest OD: 3.02 (77) Thread Size: M16 X 1.5-6H INT</p>
<p>3950445S Used with FH23027, FH23028, FH23029, FH23030, FH23031, FH23032, FH23038, FH23039, FH23040, FH23041, FH23042, FH23045, FH23049, FH23050, FH23054, FH23060, FH23061, FH23067M, FH23068M, FH23069M, FH23070, FH23400, FH23401, FH23402, FH23435, FH23438, FH23439, FH23440, FH23441, FH23453 Gasket package for Fuel Pro FH230 and Industrial Pro FH234 Series. Consists of 3952163, 3952164, and 3952207.</p> 	<p>3950857S Flexible hose</p> <hr/> <p>3950859 CUMMINS POWER GENERATION LTD 1403645</p> <hr/> <p>3950861S CUMMINS POWER GENERATION LTD 1403646</p> <hr/> <p>3950883 CUMMINS POWER GENERATION LTD 179354202</p> <hr/> <p>3950885 CUMMINS POWER GENERATION LTD 179354203</p>	<p>3951210S DAVCO 102599 WIF Harness/WIF LED Light Kit for Davco Bullet Style WIF. Contains 3946662S & 3946670S.</p>  <hr/> <p>3951337S Hump Hose</p> <hr/> <p>3951338S CUMMINS POWER GENERATION LTD 1403882</p>





E. PRODUCT GUIDE

3951339 CUMMINS POWER GENERATION LTD 179354402	3952025S Housing used with LF500 Bypass housing vertical mount assembly	3952238S CUMMINS POWER GENERATION LTD 140388603
3951359S Heater with Thermostat and O-Ring Kit 	3952026S Housing used with LF500 Bypass Mounting- Vertical or horizontal mount.	3952239S CUMMINS POWER GENERATION LTD 140388602
3951360S CUMMINS 4934880 Heater Kit 	3952027S Uses service part: LF750A, LF750B, LF750D Inverted 750 housing assembly 	3952241S CUMMINS POWER GENERATION LTD 140388503
3951366S Housing used with CH41111	3952028S Used with LF750A, LF750B, LF750D Bypass housing vertical mount assembly 	3952242S CUMMINS POWER GENERATION LTD 140388502
3951367S Housing used with CH41112	3952029S Used with LF750A, LF750B, LF750D Vertical or Horizontal Mount	3952332S DAVCO 571003 REN Slow Flow Meter Piston Valve Kit 
3951391S Used with AH19036	3952119S Uses service part: 3945120S, 3945123S, 3945136S, 3946673S Heater Kit for Fuel Pro Units	3952334S SY-KLONE 620175 Scavenger Adapter used in Dual Stage and Series 9000 Ejective Air Precleaners 
3951438S Service Kit for FH21010B4 	3952201 CUMMINS 4931690	3952349S SY-KLONE 67011 Expansion Adapter used in Dual Stage and Series 9000 Ejective Air Precleaners 
3951841S DAVCO 101813 Used with FH23200, FH23201, FH23202, FH23302, FH23303, FH23304, FH23308 120 V AC / 37W Heater for the Diesel Pro FH232/FH233 Housings 	3952221 CUMMINS POWER GENERATION LTD 179434004	3952350S SY-KLONE 68011 Expansion Adapter used in Dual Stage and Series 9000 Ejective Air Precleaners 
3951843S CUMMINS POWER GENERATION LTD 140337102	3952222 CUMMINS POWER GENERATION LTD 179434001	3952351S 7"x7" Hump House used in Dual Stage and Series 9000 Ejective Air Precleaners 
3951844S CUMMINS POWER GENERATION LTD 140336902	3952226S CUMMINS POWER GENERATION LTD 140346803	3952352S SY-KLONE 911100 Clamp used in Dual Stage and Series 9000 Ejective Air Precleaners 
3951845S CUMMINS POWER GENERATION LTD 140336702 Left Brace	3952227S CUMMINS POWER GENERATION LTD 140346802	3952353S SY-KLONE 91200 Clamp used in Dual Stage and Series 9000 Ejective Air Precleaners 
3951847S CUMMINS POWER GENERATION LTD 140336802 Right Brace	3952229S CUMMINS POWER GENERATION LTD 140346403	3952354S SY-KLONE 91588 Clamp used in Dual Stage and Series 9000 Ejective Air Precleaners 
3951848S CUMMINS POWER GENERATION LTD 140340202	3952230S CUMMINS POWER GENERATION LTD 140346402	3952355S SY-KLONE 91600 Clamp used in Dual Stage and Series 9000 Ejective Air Precleaners 
3951849S CUMMINS POWER GENERATION LTD 140336602 Left Bracket	3952232S CUMMINS POWER GENERATION LTD 140346303	
3951850S CUMMINS POWER GENERATION LTD 140336502 Right Bracket	3952233S CUMMINS POWER GENERATION LTD 140346302	
3951929S DONALDSON P603476 Mack Waste Control Equipment Overall Height: 8.08 (205) Overall OD: 5.09 (129)	3952235S CUMMINS POWER GENERATION LTD 140346703	
	3952236S CUMMINS POWER GENERATION LTD 140346702	

E. PRODUCT GUIDE

<p>3952356S SY-KLONE 91688 Clamp used in Dual Stage and Series 9000 Ejective Air Precleaners</p> 	<p>3953480S DAVCO 560267 REN Slow Flow Meter Sensor</p> 	<p>3953524S SY-KLONE D9ROPTIB Chamber used in Dual Stage and Series 9000 Ejective Air Precleaners</p> 
<p>3952357S SY-KLONE 91800 Clamp used in Dual Stage and Series 9000 Ejective Air Precleaners</p> 	<p>3953507S SY-KLONE 70012 Pipe Extension used in Dual Stage and Series 9000 Ejective Air Precleaners</p> 	<p>3953525S SY-KLONE STD60PTIB Chamber used in Dual Stage and Series 9000 Ejective Air Precleaners</p> 
<p>3952358S SY-KLONE 91900 Clamp used in Dual Stage and Series 9000 Ejective Air Precleaners</p> 	<p>3953517S CHRYSLER 5093128AA, CUMMINS 3949958 Used with FS1022, FS19616</p> 	<p>3953526S SY-KLONE STD60PTIBS2 Chamber used in Dual Stage and Series 9000 Ejective Air Precleaners</p> 
<p>3952359S SY-KLONE FH20003 2"x10" Rubber Flex Hose used in Dual Stage and Series 9000 Ejective Air Precleaners</p> 	<p>3953518S SY-KLONE 836COPTIB Chamber used in Dual Stage and Series 9000 Ejective Air Precleaners</p> 	<p>3953527S SY-KLONE STD70PTIB Chamber used in Dual Stage and Series 9000 Ejective Air Precleaners</p> 
<p>3952360S SY-KLONE OA09004 Elbow Hose used in Dual Stage and Series 9000 Ejective Air Precleaners</p> 	<p>3953519S SY-KLONE 836GOPTIB Chamber used in Dual Stage and Series 9000 Ejective Air Precleaners</p> 	<p>3953528S SY-KLONE STD70PTIBS2 Chamber used in Dual Stage and Series 9000 Ejective Air Precleaners</p> 
<p>3952361S SY-KLONE OA09008 Disposal Hose used in Dual Stage and Series 9000 Ejective Air Precleaners</p> 	<p>3953520S SY-KLONE D6ROPTIB Chamber used in Dual Stage and Series 9000 Ejective Air Precleaners</p> 	<p>3953529S Rubber Reducer used in Dual Stage and Series 9000 Ejective Air Precleaners</p> 
<p>3952362S SY-KLONE OA09009 Disposal Hose used in Dual Stage and Series 9000 Ejective Air Precleaners</p> 	<p>3953521S SY-KLONE D7ROPTIB Chamber used in Dual Stage and Series 9000 Ejective Air Precleaners</p> 	<p>3953530S SY-KLONE DB18011 Dust Boot used in Dual Stage and Series 9000 Ejective Air Precleaners</p> 
<p>3952363S SY-KLONE OA11002 Metal Adapter used in Dual Stage and Series 9000 Ejective Air Precleaners</p> 	<p>3953522S SY-KLONE D8NOPTIB Chamber used in Dual Stage and Series 9000 Ejective Air Precleaners</p> 	<p>3953531S SY-KLONE HEATSHD001 Heat Shield used in Dual Stage and Series 9000 Ejective Air Precleaners</p> 
<p>3952436S DAVCO 57023557 REN Slow Flow Meter Cycling Valve Kit</p> 	<p>3953523S SY-KLONE D8ROPTIB Chamber used in Dual Stage and Series 9000 Ejective Air Precleaners</p> 	<p>3953532S SY-KLONE OA09001 Mounting Bracket used in Dual Stage and Series 9000 Ejective Air Precleaners</p> 
<p>3952575 CUMMINS POWER GENERATION LTD 1793851</p> 	<p>3953524S SY-KLONE D9ROPTIB Chamber used in Dual Stage and Series 9000 Ejective Air Precleaners</p> 	<p>3953533S SY-KLONE OA11003 Mounting Bracket used in Dual Stage and Series 9000 Ejective Air Precleaners</p> 
<p>3952578S CUMMINS POWER GENERATION LTD 140373902</p> 	<p>3953525S SY-KLONE D8ROPTIB Chamber used in Dual Stage and Series 9000 Ejective Air Precleaners</p> 	<p>3953534S SY-KLONE OA11004 Mounting Bracket used in Dual Stage and Series 9000 Ejective Air Precleaners</p> 
<p>3952581S CUMMINS POWER GENERATION LTD 140374102</p> 	<p>3953526S SY-KLONE D9ROPTIB Chamber used in Dual Stage and Series 9000 Ejective Air Precleaners</p> 	<p>3953535S SY-KLONE OA11005 Mounting Bracket used in Dual Stage and Series 9000 Ejective Air Precleaners</p> 

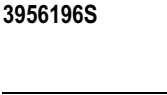







E. PRODUCT GUIDE

3953535S	SY-KLONE OA09007 Valve Check used in Dual Stage and Series 9000 Ejective Air Precleaners		3955640S	Housing used with CH41113 Cover Housing	3956944S	Special Tubing		
3953544S	SY-KLONE 9003SCR2 Screen used in Dual Stage and Series 9000 Ejective Air Precleaners		3955641S	Housing used with CH41114 Cover Housing	3956945S	Special Tubing		
3953725S	Hump Hose		3955879S	Overall Height: 0.14 (4) Largest OD: 2.76 (70) Cross Section: Round Largest ID: 2.48 (63)	3956946S	Special Tubing		
3954128S	Cover and Support for Sea Pro 7		3956011S	Industrial Pro Bottom Plate	3956947	CUMMINS POWER GENERATION LTD 22657625		
3954130S	Bowl for Sea Pro 7			3957113	CUMMINS 4959288			
3954131S	Drain Valve for Sea Pro 7		3956072S	Check Valve Assembly	3957141S	CUMMINS POWER GENERATION LTD 1306713		
3954132S	Sealing Plate for Sea Pro 7		3956093S	24DVC, 250W high temperature heater for FH230 Series Applications		3957300	CUMMINS 4940648 Head and Filter Assembly	
3954136S	DAVCO 910101 M26 Metric Adaptor Kit for Fuel Processors		3956191	Head and Filter Assembly	3957300S	CUMMINS 4990861 Head and Filter Assembly		
3954138S	DAVCO 910102 M33 Metric Adaptor Kit for Fuel Processors		3956191S	CUMMINS 4939058 Head and Filter Assembly	3957451S	Head and Filter Assembly		
3954139S	DAVCO 102381 Check Valve for use with the Industrial Pro & Sea Pro Dual/Duplex/Triple/Triplex Assemblies		3956192	Head and Filter Assembly	3957503S	CHRYSLER 680239774AB Fuel Line Kit		
3954619	JOHN DEERE F0070016 Head used with FS19511N Uses service part: 3954620S, 3954621S		3956192S	CUMMINS 4939059 Head and Filter Assembly	3957737	Aluminum Head		
3954620S	Used with 3954619, FS19511N Insert		3956193	Head and Filter Assembly	3957738	CUMMINS 4943201 Includes: FS19732 filter, 3944287 head with priming pump, 3951359 24V Heater		
3954621S	Head used with FS19511N Used with 3954619 Replacement Head Assembly		3956193S	CUMMINS 4939060 Head and Filter Assembly	3957830	Pump Assembly used on Cummins ISB07		
3954750S	Hump Hose		3956196	Head and Filter Assembly Cummins ISB07	3958111S	Service Part		
3955168S	SCANIA 1475433 Gasket		3956196S	CUMMINS 4990860 Head and Filter Assembly Cummins ISB07	3958180	Head and Filter Assembly		
			3956561S	Metric Adaptor Kit for Industrial Pro Units	3958180S	CUMMINS 4942666		
			3956562S	Heater Spacer for Industrial Pro Triple/Triplex	3958181S	CUMMINS 4942665		
				3956687	CUMMINS POWER GENERATION LTD 5411296	3958392S	Used with WF2126, WF2127, LF3703, LF3941 Gasket service pack	
				3956688	CUMMINS POWER GENERATION LTD 5411299	3958438	CUMMINS POWER GENERATION LTD 1795025	
			3956687	CUMMINS POWER GENERATION LTD 5411296	3956897	CUMMINS POWER GENERATION LTD 179354504	3958441S	CUMMINS POWER GENERATION LTD 140407902
			3956888	CUMMINS POWER GENERATION LTD 5411299	3956900S	Elbow	3958442S	CUMMINS POWER GENERATION LTD 1307324
			3956897	CUMMINS POWER GENERATION LTD 179354504	3956943S	Special Tubing	3958443S	CUMMINS POWER GENERATION LTD 503187007
			3956900S	Elbow		3958444S	Screw kit	





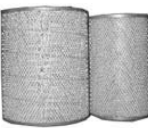

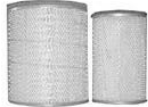



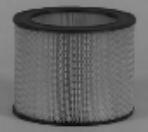







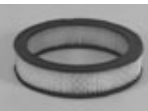

E. PRODUCT GUIDE

3958448 CUMMINS POWER GENERATION LTD 1795027	3959508S FORD D90Z6A666A PCV Mexico only 	3959520S FORD E1DZ6A666A PCV Mexico only 
3958451S CUMMINS POWER GENERATION LTD 140404102	3959509S CHRYSLER 4777240 PCV Mexico only 	3959521S CHRYSLER 5214088 PCV Mexico only 
3958452S CUMMINS POWER GENERATION LTD 5032853	3959510S Safety Element used with 8995284 PCV Mexico only 	3959522S HONDA E63Z6A666A PCV Mexico only 
3958484S CUMMINS 4898876 Upgrade of 3935185S High Performing Gasket for use in Bio-Diesel Applications Overall Height: 0.14 (4) Largest OD: 2.76 (70) Cross Section: Round Largest ID: 2.48 (63)	3959512S GMC 6487936 PCV Mexico only 	3959524S NISSAN 1181057Y00 PCV Mexico only 
3958485S Upgrade of 3834185S High Performing Gasket for use in Bio-Diesel Applications Overall Height: 0.17 (4) Largest OD: 2.74 (70) Cross Section: Rectangular Largest ID: 2.46 (62)	3959513S FORD D9ZZ6A666A PCV Mexico only 	3959525S CHRYSLER 53041134 PCV Mexico only 
3959125S Upgrade of 3925469S High Performing Gasket for use in Bio-Diesel Applications	3959514S FORD E5ZZ6A666A PCV Mexico only 	3959527S CHRYSLER 53030564 PCV Mexico only 
3959447S FS Element	3959515S GMC 25097214 PCV Mexico only 	3959745S DAVCO 102551 Metric Check Valve Fitting for Industrial Pro Series 
3959448S CUMMINS 3942466, CHRYSLER 5015585AB Heater	3959517S FORD D90Z6A666A PCV Mexico only 	3959747S NISSAN 11810F0500 PCV Mexico only 
3959449S CHRYSLER 5015578AC, CUMMINS 3937175, CUMMINS 3892545 Lid	3959518S GMC 6487778 PCV Mexico only 	3959748S DAVCO 102688 Fuel Heater kit for use with Fuel Housings 
3959452S WIF Sensor	3959519S NISSAN 1181060U00 PCV Mexico only 	3959749S DAVCO 102689 Fuel Heater Kit for use with Fuel Housings 
3959453S Drain Valve	3959505 Head and Filter Assembly 	3959750S DAVCO 102690 Fuel Heater Kit for use with Fuel Housings 
3959454S CUMMINS 3942468, CHRYSLER 5015582AB WIF Sensor	3959506S FORD D9ZZ6A666A PCV Mexico only 	3959505S CUMMINS 4945471
3959502S CHRYSLER 3671076 PCV Mexico only 	3959506S FORD D9ZZ6A666A PCV Mexico only 	3959505S CUMMINS 4945471
3959505 Head and Filter Assembly	3959507S GMC 6487778 PCV Mexico only 	3959505S CUMMINS 4945471
3959505S CUMMINS 4945471	3959507S GMC 6487778 PCV Mexico only 	3959505S CUMMINS 4945471
3959506S FORD D9ZZ6A666A PCV Mexico only 	3959507S GMC 6487778 PCV Mexico only 	3959505S CUMMINS 4945471
3959507S GMC 6487778 PCV Mexico only 	3959507S GMC 6487778 PCV Mexico only 	3959505S CUMMINS 4945471

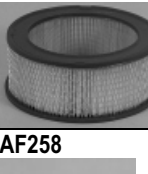

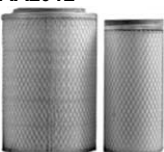









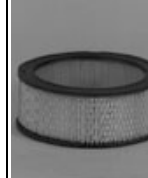

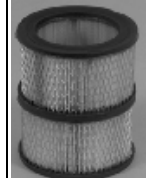





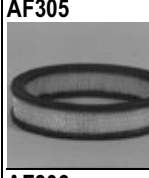

E. PRODUCT GUIDE

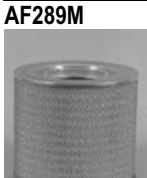
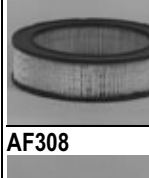
3959751S	DAVCO 102691 Fuel Heater Kit for use with Fuel Housings		3960826S	DAVCO 102756 Metal WIF for Sea Pro		3962607S	Purchase Complete from Davco, their p/n 102660FGD-92. WIF harness length is 92".
3959752S	DAVCO 102693 Fuel Heater Kit for use with Fuel Housings		3960827S	Plastic PSR lid		3962763	Uses service part: 3928013S PTC heater kit - 12V
3959753S	DAVCO 102694 Fuel Heater Kit for use with Fuel Housings		3960976S	24 Volt DC, with Biodiesel Preheater for FH233 Diesel Pro Units		3964006S	Replaces ST2023BDKIT kit
3959754S	DAVCO 102695 Fuel Heater Kit for use with Fuel Housings		3961245	LEYLAND AENB543 Fuel Water Separator Head Assembly for Cummins ISB 2007 Engines		3965311S	DAVCO 571102 Metal Bowl
3959755S	DAVCO 102696 Fuel Heater Kit for use with Fuel Housings		3961283S	Primer Pump Fitting Set for Industrial Pro Single.		3965752S	Head and Heater Package
3959771	CUMMINS POWER GENERATION LTD PN70522602		3961284S	Primer Pump Fitting Set for Industrial Pro Dual/Duplex.		3965753S	Head and Heater Package
3959836	CUMMINS POWER GENERATION LTD 5411419		3961285S	Primer Pump Fitting Set for Industrial Pro Triple/Triplex.		CPG019	CUMMINS 4933107 Exhaust Riser Assembly for Cummins B330/B370 Marine engines. Sourced from Australia.
3959961	banded seal gasket		3961286S	DAVCO 910051CEG IP single primer assembly. The primer pump assembly consists of a primer pump, bracket, hoses, vibration isolators, and all fittings.		L327009S	Dipstick for L333029S and L328471S power steering reservoirs.
3959962	copper gasket		3961287S	DAVCO 910053ICEG IP Double/Duplex/Triple/Triplex primer pump assembly. The primer pump assembly consists of a primer pump, bracket, hoses, vibration isolators, and all fittings.		L333034S	Hold down assembly for L333029S power steering reservoir.
3959962S	IRISBUS 5003062008 Copper Washer		3961293S	DAVCO 390063CEG SP single primer pump assembly. The primer pump assembly consists of a primer pump, bracket, hoses, vibration isolators, and all fittings.		S1914S	Gasket Used with LF516 Copper asbestos ring
3959963	aluminium gasket		3961294S	DAVCO 390064CEG SP Double/Duplex/Triple/Triplex primer pump assembly. The primer pump assembly consists of a primer pump, bracket, hoses, vibration isolators, and all fittings.			
3960200S	Replacement Lid & Wingnut for AP0200.		3961295S	Primer Pump Fitting Set for Sea Pro		Dual Pack Air Kits	
3960274S	PURFLUX P250 Used with FF5303, FF5354		3961296S	Primer Pump Fitting Set for Sea Pro Single.		AA2900	Kit Containing (1) AF851 and (1) AF883
3960293	CUMMINS 4959286		3962017S	Filter head for ISC engine			Overall Height: 18.49 (470) End 1 OD: 9.49 (241) End 2 OD: 13.72 (348) End 1 ID: 9.43 (239) End 2 ID: 13.76 (349)
3960300S	Replacement Lid & Wingnut for AP0300.		3962018S	CUMMINS 3944987 Head used with FS1000, FS1022		AA2901	Kit Containing (1) AF873M and (1) AF4516
3960450S	Replacement Lid & Wingnut for AP0450.		3962319S	Head Package Service Kit			
3960461S	CUMMINS 3954906 Head used with FF5421, FS20000 Replaces 3940777S		3962484S	Head Package		AA2902	Kit Containing (1) AF424 and (1) AF820M
3960500S	Replacement Lid & Wingnut for AP0500.						
3960502S	Used with HF7999					AA2903	Kit Containing (1) AF4605M and (1) AF4603
3960670S	Assembly made up of parts 3831871 (bowl) and 3834624 (oring).						
3960737	CUMMINS POWER GENERATION LTD 5411461					AA2904	Kit Containing (1) AF875M and (1) AF4514
							

E. PRODUCT GUIDE

AA2905  Kit Containing (1) AF1605M and (1) AF1604	AA2954 Kit containing (1) AF25691 and (1) AF25690	AF260 FORD B8Q9601A  Overall Height: 7.16 (182) End 1 OD: 9.46 (240) End 2 OD: 9.16 (233) End 1 ID: 6.75 (171)
AA2906 Kit Containing (1) AF879 and (1) AF857	Air Filters AF250  CUMMINS 255963 Uses service part: 154272S, 156779S, 250024S Breather For Naturally Aspirated Engines Only Overall Height: 2.73 (69) Overall OD: 2.99 (76) End 1 ID: 1.35 (34)	AF262 CUMMINS 299262  Overall Height: 15.03 (382) Overall OD: 11.94 (303) End 1 ID: 7.32 (186)
AA2907  Kit Containing (1) AF899 and (1) AF880	AF251  CUMMINS 155065, CUMMINS 256837 Filter used with 147669S Uses service part: 257014S Air Compressor Breather Overall Height: 1.28 (33) Overall OD: 4.92 (125) End 1 ID: 3.00 (76)	AF263 ALLIS-CHALMERS 4052520  Overall Height: 16.39 (416) Overall OD: 12.08 (307)) End 1 ID: 7.94 (202)
AA2907M  Kit Containing (1) AF899M and (1) AF880	AF252  CUMMINS 299252 Pre-Cleaner Blanket is AF1844 Overall Height: 10.06 (256) End 1 OD: 9.23 (234) End 2 OD: 9.21 (234) End 1 ID: 0.40 (10) End 2 ID: 6.61 (168)	AF264  CUMMINS 299264 Safety Element used with AF936 Overall Height: 12.04 (306) Overall OD: 10.21 (259) End 1 ID: 5.54 (141)
AA2908 Kit Containing (1) AF421 and (1) AF821M	AF253  CUMMINS 299253 Uses service part: 3835841S, 3835842S Optional Gaskets For Fram Housing Overall Height: 12.06 (306) Overall OD: 10.40 (264) End 1 ID: 7.80 (198) End 2 ID: 0.40 (10)	AF265  CUMMINS 124721, CUMMINS 299265 Overall Height: 10.06 (255) Overall OD: 8.99 (228) End 1 ID: 4.33 (110)
AA2909 Ford (Outer Element) Ford (Inner Element) Elements Not Available Separately	AF255  CHRYSLER 1929429 Overall Height: 3.67 (93) End 1 OD: 3.30 (84) End 2 OD: 3.28 (83) End 1 ID: 1.97 (50)	AF267  FORD C1KE9601A Overall Height: 2.26 (57) Overall OD: 9.76 (248) End 1 ID: 7.94 (202)
AA2910  Kit Containing (1) AF911 and (1) AF910 Overall Height: 24.00 (609) Overall OD: 12.77 (324) End 1 ID: 8.36 (212)	AF257  FORD B7A9601C Overall Height: 3.62 (92) End 1 OD: 9.43 (240) End 2 OD: 9.14 (232) End 1 ID: 6.88 (175)	AF269  CHRYSLER 2120933 Overall Height: 6.00 (152) Overall OD: 10.21 (259) End 1 ID: 5.54 (141)
AA2912  Kit containing (1) AF1768M and (1) AF1767	AF258  CASE 150868R91 Overall Height: 7.62 (194) Overall OD: 8.09 (205) End 1 ID: 0.44 (11) End 2 ID: 5.75 (146)	AF277  CASE 156073C91 Overall Height: 8.56 (217) Overall OD: 6.06 (154) End 1 ID: 4.56 (116)
AA2920  Kit containing (1) AF4504M and (1) AF1791	AF259  CUMMINS 106836, CUMMINS 299259 Fram FA-210PL Series Overall Height: 7.95 (202) Overall OD: 6.68 (170) End 1 ID: 4.19 (106) End 2 ID: 0.30 (8)	
AA2921 Kit containing (1) AF434KM and (1) AF804M		
AA2948 Kit Containing (1) AF25277 and (1) AF25276		
AA2950 Kit containing (1) AF928M and (1) AF26380M		
AA2951 Kit containing (1) AF26410 and (1) AF26411		
AA2952 Kit containing (1) AF26412 and (1) AF26414		
AA2953 Kit containing (1) AF26413 and (1) AF26414		

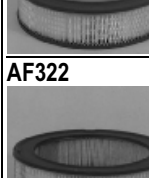
E. PRODUCT GUIDE

AF278  CUMMINS 299278, CASE 301659R91 Overall Height: 18.50 (470) Overall OD: 8.08 (205) End 1 ID: 5.69 (145)	AF297  PUROLATOR AF2 Overall Height: 4.00 (102) Overall OD: 8.08 (205) End 1 ID: 5.77 (147) End 2 ID: 0.25 (6)	AF324  FORD C2OZ9601A Overall Height: 3.26 (83) Overall OD: 8.40 (213) End 1 ID: 6.59 (167)
AF281  GMC 2308840 Overall Height: 2.50 (64) Overall OD: 3.00 (76) End 1 ID: 1.62 (41)	AF303  CUMMINS 299303, CATERPILLAR 2M2626 for Magnum Version use AF303M Overall Height: 10.50 (267) End 1 OD: 10.46 (266) End 2 OD: 10.40 (264) End 1 ID: 5.25 (133) End 2 ID: 7.80 (198)	AF329  GMC 5647033 Primary Air; Two Elements Required Overall Height: 3.16 (80) Overall OD: 5.28 (134) End 1 ID: 3.88 (99)
AF284  CLARK 880044 Overall Height: 7.00 (178) Overall OD: 4.38 (111) End 1 ID: 3.00 (76)	AF303M  DONALDSON P119596 Extended Life Version of AF303 Overall Height: 10.50 (267) End 1 OD: 10.46 (266) End 2 OD: 10.40 (264) End 1 ID: 5.25 (133) End 2 ID: 7.80 (198)	AF331  CATERPILLAR 4L9851 Overall Height: 8.31 (211) Overall OD: 10.40 (264) End 1 ID: 6.05 (154)
AF285  CUMMINS 133739, CUMMINS 299285 250806 Bolt Seal Included Overall Height: 9.04 (230) End 1 OD: 8.41 (214) End 2 OD: 8.40 (213) End 1 ID: 5.79 (147) End 2 ID: 0.54 (14)	AF304M  CUMMINS 150449, CUMMINS 299304, CATERPILLAR 1M3424, CATERPILLAR 1S6079 Overall Height: 10.50 (267) End 1 OD: 11.64 (296) End 2 OD: 11.58 (294) End 1 ID: 6.18 (157) End 2 ID: 8.98 (228)	AF332  CATERPILLAR 4L9852 Overall Height: 12.31 (313) Overall OD: 10.40 (264) End 1 ID: 6.05 (154)
AF289  CUMMINS 299289, CATERPILLAR 2M7941, CATERPILLAR 2S5648 For Magnum Version, Use AF289M Overall Height: 11.54 (293) End 1 OD: 12.83 (326) End 2 OD: 12.77 (324) End 1 ID: 5.94 (151) End 2 ID: 8.36 (212)	AF305  GMC 6422866, GMC 5649797 Overall Height: 2.04 (52) Overall OD: 9.68 (246) End 1 ID: 8.12 (206)	AF333  CATERPILLAR 4L4718 Overall Height: 12.21 (310) Overall OD: 13.83 (351) End 1 ID: 9.49 (241)
AF289M  DONALDSON P119417 Extended Life Version of AF289 Overall Height: 11.54 (293) End 1 OD: 12.83 (326) End 2 OD: 12.77 (324) End 1 ID: 5.94 (151) End 2 ID: 8.36 (212)	AF306  GMC 6422880 Overall Height: 3.06 (78) Overall OD: 11.44 (291) End 1 ID: 8.61 (219)	AF335M  CATERPILLAR 4M9334 Primary Air Filter used with AF338, AF959 Overall Height: 13.48 (342) End 1 OD: 11.08 (281) End 2 OD: 11.08 (281) End 1 ID: 6.73 (171)
AF290  TOWMOTOR 333660 Overall Height: 3.01 (76) End 1 OD: 6.69 (170) End 2 OD: 6.41 (163) End 1 ID: 5.00 (127)	AF308  CHRYSLER 1739548 Overall Height: 3.02 (77) End 1 OD: 8.31 (211) End 2 OD: 8.00 (203) End 1 ID: 6.50 (165)	AF336M  CATERPILLAR 7M9045, CAMECO INDUSTRIES 60010832 Primary Air Filter used with AF340, AF4769 For Inner Air use AF340 or AF4769 depending on the application Overall Height: 16.48 (418) End 1 OD: 11.08 (281) End 2 OD: 11.08 (281) End 1 ID: 6.73 (171)
AF291  AMERICAN MOTORS 8991012 Overall Height: 3.00 (76) End 1 OD: 6.68 (170) End 2 OD: 6.37 (162) End 1 ID: 4.12 (105)	AF311  CHRYSLER 1739547 Overall Height: 2.75 (70) Overall OD: 10.00 (254) End 1 ID: 7.54 (192)	AF337  CATERPILLAR 4M9378 Primary Air Filter used with AF341 Overall Height: 10.49 (266) Overall OD: 8.39 (213) End 1 ID: 4.00 (102)
	AF322  FORD C3AZ9601B Overall Height: 2.58 (66) Overall OD: 9.69 (246) End 1 ID: 7.44 (189)	

E. PRODUCT GUIDE

AF338



CATERPILLAR 2S1286,
CATERPILLAR 4M9335,
CATERPILLAR 4M9339 Safety
Element used with AF335M
Fleetguard Airkit Option
AF4513 + AK2

Overall Height: 13.09 (333)
Flange Diameter: 9.06 (230)
End 2 OD: 6.28 (160)
End 1 ID: 4.63 (117)

AF340



CATERPILLAR 2S1287 Safety
Element used with AF336M
Fleetguard Airkit Option
AF4526 + AK00004

Overall Height: 16.15 (410)
End 1 OD: 9.06 (230)
End 2 OD: 6.28 (160)
End 2 ID: 4.62 (117)

AF341



CATERPILLAR 2S1284,
CATERPILLAR 4M9379 Safety
Element used with AF337

Overall Height: 11.41 (290)
Flange Diameter: 6.72 (171)
End 2 OD: 3.75 (95)
End 1 ID: 2.63 (67)

AF343



CATERPILLAR 2S1285,
CATERPILLAR 4M8048 Safety
Element used with AF344M
Fleetguard Airkit Option
AF4512 + AK00001

Overall Height: 13.22 (336)
Flange Diameter: 7.31 (186)
End 2 OD: 4.75 (121)
End 1 ID: 3.66 (93)

AF344M



CATERPILLAR 4M8047
Primary Air Filter used with
AF343, AF4639

Overall Height: 12.40 (315)
End 1 OD: 9.22 (234)
End 1 ID: 4.86 (123)

AF345



CATERPILLAR 7M8183

Overall Height: 3.86 (98)
Overall OD: 2.99 (76)
End 1 ID: 1.52 (39)

AF346K



CUMMINS 158879, CUMMINS
299346 For Magnum Version
use AF346KM 250806 Bolt
Seal Included

Overall Height: 14.51 (369)
Fin Diameter: 15.80 (401)
End 1 OD: 15.80 (401)
End 2 OD: 12.08 (307)
End 1 ID: 7.73 (196)
End 2 ID: 0.54 (14)

AF346KM



DONALDSON P117332,
DONALDSON P117639,
DONALDSON XLP182001
Extended Life version of
AF346K 250806 Bolt Seal
Included

Overall Height: 14.51 (369)
Fin Diameter: 15.80 (401)
End 2 OD: 12.08 (307)
End 1 ID: 7.73 (196)
End 2 ID: 0.54 (14)

AF347M



FIAT-ALLIS 74055092,
CUMMINS 150785, CUMMINS
299347 250806 Bolt Seal
Included

Overall Height: 13.06 (332)
Overall OD: 12.08 (307)
End 1 ID: 7.73 (196)
End 2 ID: 0.54 (14)

AF348



CUMMINS 299348 For filter
with gasket use AF414M, for
Magnum Version use AF348M
250806 Bolt Seal Included

Overall Height: 10.06 (256)
Overall OD: 12.08 (307)
End 1 ID: 7.73 (196)
End 2 ID: 0.54 (14)

AF348M



DONALDSON P117811,
DONALDSON P119241,
DONALDSON XLP182032
Extended Life Version of
AF348 250806 Bolt Seal
Included

Overall Height: 10.06 (256)
Overall OD: 12.08 (307)
End 1 ID: 7.73 (196)
End 2 ID: 0.54 (14)

AF349

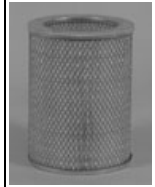

CUMMINS 150778, CUMMINS
299349 For Magnum Version
use AF349M 250806 Bolt Seal
Included

Overall Height: 11.05 (281)
End 1 OD: 8.41 (214)
End 2 OD: 8.40 (213)
End 1 ID: 5.79 (147)
End 2 ID: 5.35 (136)

AF349M



DONALDSON P118340,
DONALDSON XLP182071
Extended Life Version of
AF349 250806 Bolt Seal
Included

Overall Height: 11.06 (281)
End 1 OD: 8.41 (214)
End 2 OD: 8.40 (213)
End 1 ID: 5.79 (147)
End 2 ID: 0.54 (14)

AF350K



CUMMINS 158876, CUMMINS
299350 For Magnum Version
use AF350KM 250806 Bolt
Seal Included

Overall Height: 10.56 (268)
Fin Diameter: 10.08 (256)
End 2 OD: 7.93 (201)
End 1 ID: 3.60 (91)
End 2 ID: 0.54 (14)

AF350KM



DONALDSON P118159,
DONALDSON P119247,
DONALDSON XLP182045
Extended Life Version Of
AF350K 250806 Bolt Seal
Included

Overall Height: 10.56 (268)
Fin Diameter: 10.08 (256)
End 2 OD: 7.93 (201)
End 1 ID: 3.60 (91)
End 2 ID: 0.54 (14)

AF351K



CUMMINS 158878, CUMMINS
299351 For Magnum Version
use AF351KM 250806 Bolt
Seal Included

Overall Height: 12.44 (316)
Fin Diameter: 13.80 (351)
End 1 OD: 13.80 (351)
End 2 OD: 11.08 (281)
End 1 ID: 6.73 (171)
End 2 ID: 0.54 (14)

AF351KM



DONALDSON P117331,
DONALDSON XLP182000
Extended Life Version of
AF351K 250806 Bolt Seal
Included

Overall Height: 12.44 (316)
Fin Diameter: 13.80 (351)
End 1 OD: 13.80 (351)
End 2 OD: 11.08 (281)
End 1 ID: 6.73 (171)
End 2 ID: 0.54 (14)

AF352M



CUMMINS 151807, CUMMINS
299352

Overall Height: 9.02 (229)
End 1 OD: 6.85 (174)
End 2 OD: 6.83 (174)
End 2 ID: 4.23 (107)

AF353K

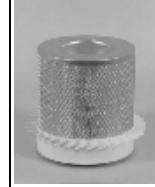

CUMMINS 158877, CUMMINS
299353 For Magnum Version
use AF353KM 250806 Bolt
Seal Included

Overall Height: 10.56 (268)
Fin Diameter: 11.70 (297)
End 2 OD: 9.21 (234)
End 1 ID: 4.86 (123)
End 2 ID: 0.54 (14)

AF353KM

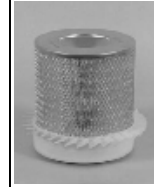

DONALDSON P117431,
DONALDSON P119234,
DONALDSON XLP182035
Extended Life Version of
AF353K 250806 Bolt Seal
Included

Overall Height: 10.56 (268)
Fin Diameter: 11.70 (297)
End 2 OD: 9.21 (234)
End 1 ID: 4.86 (123)
End 2 ID: 0.54 (14)























AF354

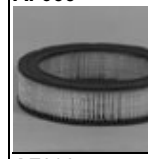

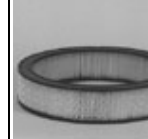
CUMMINS 150749, CUMMINS
299354 Same as AF4529 w/o
gasket For Magnum Version
use AF354M 250806 Bolt Seal
Included

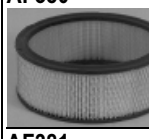
Overall Height: 9.06 (230)
Overall OD: 10.40 (264)
End 1 ID: 6.05 (154)
End 2 ID: 0.54 (14)

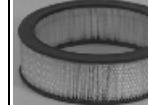

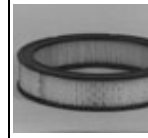
E. PRODUCT GUIDE

<p>AF354M DONALDSON P118158, DONALDSON P119245, DONALDSON XLP184033 Extended Life Version of AF354 250806 Bolt Seal Included</p>  <p>Overall Height: 9.06 (230) Overall OD: 10.40 (264) End 1 OD: 10.40 (264) End 1 ID: 6.05 (154) End 2 ID: 0.54 (14)</p>	<p>AF364 CUMMINS 299364</p>  <p>Overall Height: 1.40 (36) Overall OD: 2.99 (76) End 1 ID: 1.35 (34)</p>	<p>AF384 DONALDSON P102183 For Magnum Version use AF384M 250806 Bolt Seal Included</p>  <p>Overall Height: 7.56 (192) Overall OD: 13.83 (351) End 1 ID: 11.23 (285) End 2 ID: 0.54 (14)</p>
<p>AF355 PUROLATOR AF71</p>  <p>Overall Height: 4.00 (102) Overall OD: 5.94 (151) End 1 ID: 3.25 (83) End 2 ID: 0.25 (6)</p>	<p>AF371 WHITE 3103029 Safety Element used with AF360</p>  <p>Overall Height: 15.38 (391) Overall OD: 8.08 (205) End 1 ID: 5.75 (146)</p>	<p>AF384M DONALDSON P119184 Extended Life Version of AF384. 250806 Bolt Seal Included</p>  <p>Overall Height: 7.56 (192) Overall OD: 13.83 (351) End 1 ID: 11.23 (285) End 2 ID: 0.54 (14)</p>
<p>AF360 WHITE 3103028 Primary Air Filter used with AF371</p>  <p>Overall Height: 16.05 (408) Overall OD: 14.18 (360) End 1 ID: 9.79 (249)</p>	<p>AF373 VORTOX VF120A 250806 Bolt Seal Included</p>  <p>Overall Height: 10.31 (262) End 1 OD: 8.89 (226) End 1 ID: 4.98 (127) End 2 ID: 0.44 (11)</p>	<p>AF386 CUMMINS 209892</p>  <p>Overall Height: 6.38 (162) Overall OD: 9.62 (244) End 1 ID: 5.00 (127)</p>
<p>AF361 MACK 2191P102090 Same as AF1871M w/o gasket. For Magnum Version use AF361M 250806 Bolt Seal Included</p>  <p>Overall Height: 16.05 (408) End 1 OD: 13.83 (351) End 1 ID: 9.48 (241) End 2 ID: 0.54 (14)</p>	<p>AF374 VORTOX VF160A 250806 Bolt Seal Included</p>  <p>Overall Height: 13.51 (343) Overall OD: 11.87 (301) End 1 ID: 7.13 (181) End 2 ID: 0.44 (11)</p>	<p>AF387 CUMMINS 209890</p>  <p>Overall Height: 7.88 (200) Overall OD: 9.62 (244) End 1 ID: 5.00 (127)</p>
<p>AF361M DONALDSON P117808, DONALDSON P119238, DONALDSON XLP182036 Extended Life Version of AF361.250806 Bolt Seal Included</p>  <p>Overall Height: 16.06 (408) Overall OD: 13.83 (351) End 1 ID: 9.48 (241) End 2 ID: 0.54 (14)</p>	<p>AF376 VORTOX VF135A 250806 Bolt Seal Included</p>  <p>Overall Height: 10.56 (268) Overall OD: 10.39 (264) End 1 ID: 5.49 (139) End 2 ID: 0.44 (11)</p>	<p>AF388 FORD C4ZF9601B, FORD C5Z29601B</p>  <p>Overall Height: 2.36 (60) Overall OD: 10.00 (254) End 1 ID: 7.54 (192)</p>
<p>AF362 CUMMINS 151688, CUMMINS 299362 w/ gasket use AF413 For Magnum Version use AF362M. 250806 Bolt Seal Included</p>  <p>Overall Height: 14.05 (357) Overall OD: 13.83 (351) End 1 ID: 9.48 (241) End 2 ID: 0.54 (14)</p>	<p>AF378 VORTOX VF100A 250806 Bolt Seal Included</p>  <p>Overall Height: 10.56 (268) End 1 OD: 7.39 (188) End 1 ID: 3.49 (89) End 2 ID: 0.44 (11)</p>	<p>AF390 GMC 6421746</p>  <p>Overall Height: 3.05 (77) Overall OD: 13.88 (353) End 1 ID: 11.62 (295)</p>
<p>AF362M DONALDSON P117809, DONALDSON P119239, DONALDSON XLP182031 Extended Life Version of AF362. 250806 Bolt Seal Included</p>  <p>Overall Height: 14.06 (357) Overall OD: 13.83 (351) End 1 ID: 9.48 (241) End 2 ID: 0.54 (14)</p>	<p>AF380 GMC 6419892, GMC 6420934</p>  <p>Overall Height: 3.50 (89) Overall OD: 9.71 (247) End 1 ID: 8.18 (208)</p>	<p>AF399 GMC 6483644</p>  <p>Overall Height: 2.64 (67) Overall OD: 12.62 (321) End 1 ID: 10.84 (275)</p>
	<p>AF381 CLARK 1800562, ONAN 140B495</p>  <p>Overall Height: 3.31 (84) Overall OD: 4.25 (108) End 1 ID: 3.00 (76)</p>	<p>AF400 GMC 6484235</p>  <p>Overall Height: 3.47 (88) Overall OD: 12.00 (305) End 1 ID: 9.88 (251)</p>
	<p>AF383 CUMMINS 299383</p>  <p>Overall Height: 9.04 (230) End 1 OD: 8.41 (214) End 2 OD: 8.40 (213) End 1 ID: 5.79 (147)</p>	<p>AF401 GMC 6483645</p>  <p>Overall Height: 2.48 (63) Overall OD: 12.00 (305) End 1 ID: 9.88 (251)</p>











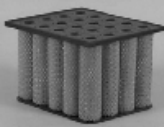

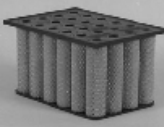

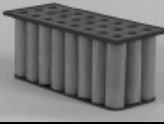
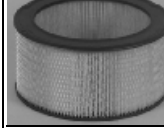

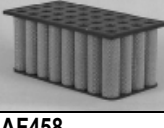

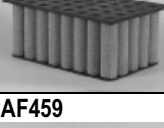
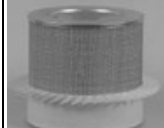

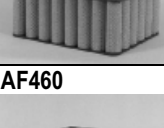

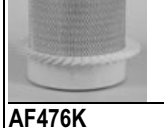
E. PRODUCT GUIDE

AF402  CHRYSLER 2863349 Overall Height: 2.75 (70) Overall OD: 12.80 (325) End 1 ID: 11.04 (280)	AF409K  Primary Air Filter used with AF1980, AF4813 Filter used with AH19110 Some European applications use AF1980. For Magnum Version use AF409KM. 3311624 Bolt Seal Included Overall Height: 12.43 (316) Fin Diameter: 7.85 (200) End 2 OD: 6.08 (154) End 1 ID: 3.48 (88) End 2 ID: 0.67 (17)	AF416  FORD C5TZ9601A, DONALDSON P106510 This element to be used only after Donaldson FWB-12-0009 kit has been installed. 250806 Bolt Seal Included Overall Height: 10.46 (266) Overall OD: 9.21 (234) End 1 ID: 4.86 (123) End 2 ID: 0.54 (14)
AF403  FORD C8AF9601A Overall Height: 2.81 (71) Overall OD: 13.00 (330) End 1 ID: 11.22 (285)	AF409KM  DONALDSON P118160, DONALDSON XLP182054 Filter used with AH19110 Extended Life Version of AF409K. 3311624 Bolt Seal Included Overall Height: 12.43 (316) Fin Diameter: 7.85 (200) End 2 OD: 6.08 (154) End 1 ID: 3.48 (88) End 2 ID: 0.67 (17)	AF417K  FIAT-ALLIS 73040631 3311624 Bolt Seal Included Overall Height: 13.56 (344) Fin Diameter: 11.70 (297) End 2 OD: 9.21 (234) End 1 ID: 4.86 (123) End 2 ID: 0.67 (17)
AF405  AC A331C Overall Height: 2.58 (66) Overall OD: 10.75 (273) End 1 ID: 8.61 (219)	AF410  FORD C8T29601A Overall Height: 2.15 (55) Overall OD: 10.88 (276) End 1 ID: 8.95 (227)	AF418  FIAT-ALLIS 73050258, FIAT-ALLIS 70660360, FRANKLIN 1513159 Primary Air Filter used with AF490M For element w/ fin use AF489K. For Magnum Version use AF418M. 3311624 Bolt Seal Included Overall Height: 13.56 (344) Overall OD: 9.21 (234) End 1 ID: 4.86 (123) End 2 ID: 0.67 (17)
AF406  GMC 2493708, CASE 303642C91 Overall Height: 3.00 (76) Overall OD: 13.00 (330) End 1 ID: 10.50 (267)	AF411  FORD C9Z29601A Overall Height: 2.11 (54) Overall OD: 11.75 (298) End 1 ID: 9.56 (243)	AF418M  DONALDSON P117439, DONALDSON XLP182034 Primary Air Filter used with AF490M Filter used with AH19070 Extended Life Version of AF418. 3311624 Bolt Seal Included Overall Height: 13.56 (344) Overall OD: 9.21 (234) End 1 ID: 4.86 (123) End 2 ID: 0.67 (17)
AF407  WHITE 3107361 For Magnum Version use AF407M. 3311624 Bolt Seal Included Overall Height: 13.56 (344) Overall OD: 11.08 (281) End 1 ID: 6.73 (171) End 2 ID: 0.67 (17)	AF413  CASE 346779R91 w/gasket w/o gasket use AF362. 250806 Bolt Seal Included Gasket: 3309167 (1) Overall Height: 14.56 (370) Overall OD: 13.83 (351) End 1 ID: 9.48 (241) End 2 ID: 0.54 (14)	AF420KM  DONALDSON P106822, DONALDSON P108786, DONALDSON P118746 3311624 Bolt Seal Included Overall Height: 6.07 (154) Fin Diameter: 11.70 (297) End 2 OD: 9.21 (234) End 1 ID: 0.67 (17) End 2 ID: 4.86 (123)
AF407M  DONALDSON P119720 Extended Life Version of AF407. 3311624 Bolt Seal Included Overall Height: 13.56 (344) Overall OD: 11.08 (281) End 1 ID: 6.73 (171) End 2 ID: 0.67 (17)	AF414M  CASE 346777R91 w/gasket w/o gasket use AF348. 250806 Bolt Seal Included Overall Height: 10.51 (267) Overall OD: 12.08 (307) End 1 ID: 7.73 (196) End 2 ID: 0.54 (14)	AF421M  EUCLID 9035429 Primary Air Filter used with AF821M Extended Life Version of AF421 Overall Height: 16.46 (418) Overall OD: 12.08 (307) End 1 ID: 7.73 (196)
AF408  WHITE 545249 Primary Air Filter used with AF920 For Magnum Version use AF408M 3311624 Bolt Seal Included Overall Height: 13.56 (344) End 1 OD: 7.77 (197) End 2 OD: 11.93 (303) End 1 ID: 7.73 (196) End 2 ID: 12.02 (305)	AF415K  For Magnum Version use AF415KM. 250806 Bolt Seal Included Overall Height: 10.62 (270) Fin Diameter: 11.70 (297) End 2 OD: 9.21 (234) End 1 ID: 0.54 (14) End 2 ID: 4.86 (123)	AF422  MACK 2MD49303A Primary Air 250806 Bolt Seal Included Overall Height: 12.38 (314) Overall OD: 12.08 (307) End 1 ID: 7.73 (196) End 2 ID: 0.54 (14)
AF408M  DONALDSON P117327 Extended Life Version of AF408. 3311624 Bolt Seal Included Overall Height: 13.56 (344) End 1 OD: 7.77 (197) End 2 OD: 11.93 (303) End 1 ID: 7.72 (196) End 2 ID: 12.02 (305)	AF415KM  DONALDSON P118343 Extended Life Version of AF415KM. 250806 Bolt Seal Included Overall Height: 10.62 (270) Fin Diameter: 11.70 (297) End 2 OD: 9.21 (234) End 1 ID: 0.54 (14) End 2 ID: 4.86 (123)	

E. PRODUCT GUIDE

<p>AF423K</p>  <p>MACK 2MD3110, WHITE 3891H21 250806 Bolt Seal Included</p> <p>Overall Height: 8.44 (214) Fin Diameter: 13.80 (351) End 2 OD: 11.08 (281) End 1 ID: 6.73 (171) End 2 ID: 0.54 (14)</p>	<p>AF434KM</p>  <p>ALLIS-CHALMERS 654409, CUMMINS 196677 Primary Air Filter used with AF4589, AF804M Filter used with AH19067, AH19068 For inner air on some applications use AF804M, AF4589. 3311624 Bolt Seal Included</p> <p>Overall Height: 16.58 (421) Fin Diameter: 10.08 (256) End 2 OD: 7.93 (201) End 1 ID: 5.33 (135) End 2 ID: 0.67 (17)</p>	<p>AF439</p>  <p>HOUGH 214349H1, UNITED AIR CLEANER 250C14S</p> <p>Overall Height: 9.50 (241) End 1 OD: 6.94 (176) End 2 OD: 6.92 (176) End 1 ID: 4.88 (124) End 2 ID: 4.44 (113)</p>
<p>AF424</p>  <p>CASE 702322C1 Primary Air Filter used with AF820M For Magnum Version use AF424M 3311624 Bolt Seal Included</p> <p>Overall Height: 16.56 (421) End 1 OD: 11.09 (282) End 2 OD: 11.08 (281) End 1 ID: 0.67 (17) End 2 ID: 6.73 (171)</p>	<p>AF435KM</p>  <p>DONALDSON SMP181050 Primary Air Filter used with AF4660, AF4850. 3311624 Bolt Seal Included</p> <p>Overall Height: 10.43 (265) Fin Diameter: 5.16 (131) End 2 OD: 4.08 (104) End 1 ID: 2.56 (65) End 2 ID: 0.67 (17)</p>	<p>AF444</p>  <p>FARR P4, CARRIER 300031600, TRANSICOLD 300031600 Inside-Out Flow(2 x 2)</p> <p>Height: 8.18 (208) Length: 8.13 (207) Width: 5.97 (152)</p>
<p>AF424M</p>  <p>DONALDSON P117437, DONALDSON XLP182046 Filter used with AH19072 Extended Life Version of AF424. 3311624 Bolt Seal Included</p> <p>Overall Height: 16.56 (421) Overall OD: 11.08 (281) End 1 ID: 6.73 (171)</p>	<p>AF436M</p>  <p>DONALDSON P19175, DONALDSON P118342</p> <p>Overall Height: 8.06 (205) Overall OD: 5.24 (133) End 1 ID: 2.71 (69)</p>	<p>AF445</p>  <p>FARR P6 (2 x 3) Inside-Out Flow</p> <p>Height: 8.18 (208) Length: 8.25 (210) Width: 5.97 (152)</p>
<p>AF426</p>  <p>DONALDSON P109685 250806 Bolt Seal Included</p> <p>Overall Height: 8.94 (227) Overall OD: 13.83 (351) End 1 ID: 9.48 (241) End 2 ID: 0.54 (14)</p>	<p>AF437K</p>  <p>DONALDSON P101222, DONALDSON SMP181052 Primary Air Filter used with AF4510 Filter used with AH19109 For Magnum Version use AF437KM. For Flame Retardant version use AF4545K. 3311624 Bolt Seal Included</p> <p>Overall Height: 11.43 (290) Fin Diameter: 6.34 (161) End 2 OD: 5.24 (133) End 1 ID: 2.71 (69) End 2 ID: 0.67 (17)</p>	<p>AF446</p>  <p>FARR P9 (3 x 3) Inside-Out Flow</p> <p>Height: 8.18 (208) Length: 8.25 (210) Width: 8.25 (210)</p>
<p>AF427M</p>  <p>DONALDSON P109200, DONALDSON P117433, DONALDSON SMP181044, CAMECO INDUSTRIES 60019277 Primary Air Filter used with AF822M, AF938 830497 Bolt Seal Included</p> <p>Overall Height: 14.55 (370) Overall OD: 10.40 (264) End 1 ID: 6.05 (154) End 2 ID: 0.91 (23)</p>	<p>AF437KM</p>  <p>DONALDSON P119775, DONALDSON XLP182052 Primary Air Filter used with AF4510 Filter used with AH19109 Extended Life Version of AF437K. 3311624 Bolt Seal Included</p> <p>Overall Height: 11.43 (290) Fin Diameter: 6.34 (161) End 2 OD: 5.24 (133) End 1 ID: 2.71 (69) End 2 ID: 0.67 (17)</p>	<p>AF447</p>  <p>FARR P12 (3 x 4) Inside-Out Flow</p> <p>Height: 8.18 (208) Length: 10.56 (268) Width: 8.25 (210)</p>
<p>AF429</p>  <p>BUCYRUS-ERIE 362538</p> <p>Overall Height: 9.00 (229) Overall OD: 10.40 (264) End 1 ID: 7.80 (198)</p>	<p>AF438</p>  <p>UNITED AIR CLEANER 250C6S</p> <p>Overall Height: 20.27 (515) End 1 OD: 7.05 (179) End 2 OD: 6.99 (178) End 2 ID: 4.42 (112)</p>	<p>AF448</p>  <p>FARR P1226 (2 x 6) Inside-Out Flow</p> <p>Height: 8.18 (208) Length: 15.19 (386) Width: 5.97 (152)</p>
<p>AF433K</p>  <p>FIAT-ALLIS 73038733, FIAT-ALLIS 73039921 . 250806 Bolt Seal Included</p> <p>Overall Height: 13.56 (344) Fin Diameter: 10.70 (272) End 2 OD: 7.93 (201) End 1 ID: 3.58 (91) End 2 ID: 0.54 (14)</p>	<p>AF438</p>  <p>UNITED AIR CLEANER 250C6S</p> <p>Overall Height: 20.27 (515) End 1 OD: 7.05 (179) End 2 OD: 6.99 (178) End 2 ID: 4.42 (112)</p>	<p>AF449</p>  <p>FARR P16 (4 x 4) Inside-Out Flow</p> <p>Height: 8.18 (208) Length: 10.56 (268) Width: 10.56 (268)</p>
		<p>AF450</p>  <p>FARR P1628 (2 x 8) Inside-Out Flow</p> <p>Height: 8.18 (208) Length: 5.97 (152) Width: 19.81 (503)</p>

E. PRODUCT GUIDE

<p>AF452 FARR P20 (4 x 5) Inside-Out Flow</p>  <p>Height: 8.18 (208) Length: 12.88 (327) Width: 10.56 (268)</p>	<p>AF462KM DONALDSON P119112 3311624 Bolt Seal Included</p>  <p>Overall Height: 10.62 (270) Fin Diameter: 13.80 (351) End 2 OD: 11.08 (281) End 1 ID: 0.67 (17) End 2 ID: 6.73 (171)</p>	<p>AF472M DONALDSON P117443, DONALDSON XLP182002, NEW HOLLAND 70659387 Extended Life Version of AF472. 3311624 Bolt Seal Included</p>  <p>Overall Height: 18.50 (470) Overall OD: 12.09 (307) End 1 ID: 7.72 (196)</p>
<p>AF453 FARR P24 (4 x 6) Inside-Out Flow</p>  <p>Height: 8.18 (208) Length: 15.19 (386) Width: 10.56 (268)</p>	<p>AF463 FORD C8HZ9601C . 3311624 Bolt Seal Included</p>  <p>Overall Height: 11.44 (290) Overall OD: 9.21 (234) End 1 ID: 4.86 (123) End 2 ID: 0.67 (17)</p>	<p>AF473K FORD D0HZ9601C For Magnum Version use AF473KM. 3311624 Bolt Seal Included</p>  <p>Overall Height: 14.50 (368) Fin Diameter: 13.80 (351) End 2 OD: 11.08 (281) End 1 ID: 6.73 (171) End 2 ID: 0.67 (17)</p>
<p>AF454 FARR P2438 (3 x 8) Inside-Out Flow</p>  <p>Height: 8.18 (208) Length: 19.81 (503) Width: 8.25 (210)</p>	<p>AF465 GMC 6421161, GMC 6423239</p>  <p>Overall Height: 5.55 (141) Overall OD: 11.43 (290) End 1 ID: 8.61 (219)</p>	<p>AF473KM DONALDSON P119113 Extended Life Version of AF473K. 3311624 Bolt Seal Included</p>  <p>Overall Height: 14.50 (368) Fin Diameter: 13.80 (351) End 2 OD: 11.08 (281) End 1 ID: 0.67 (17) End 2 ID: 6.73 (171)</p>
<p>AF456 FARR P32 (4 x 8) Inside-Out Flow</p>  <p>Height: 8.18 (208) Length: 19.81 (503) Width: 10.56 (268)</p>	<p>AF467K MACK 2191P112188</p>  <p>Overall Height: 13.56 (344) Fin Diameter: 13.80 (351) End 2 OD: 11.08 (281) End 1 ID: 6.73 (171)</p>	<p>AF474K DONALDSON P134741, DONALDSON SMP181067 For Magnum Version use AF474KM. 3311624 Bolt Seal Included</p>  <p>Overall Height: 16.44 (417) Fin Diameter: 15.80 (401) End 2 OD: 12.09 (307) End 1 ID: 7.73 (196) End 2 ID: 0.67 (17)</p>
<p>AF458 FARR P40 (5 x 8) Inside-Out Flow</p>  <p>Height: 8.18 (208) Length: 19.81 (503) Width: 12.88 (327)</p>	<p>AF468KM GMC 643276</p>  <p>Overall Height: 11.44 (290) Fin Diameter: 15.80 (401) End 2 OD: 12.08 (307) End 1 ID: 7.73 (196) End 2 ID: 0.54 (14)</p>	<p>AF474KM DONALDSON P117185 3311624 Bolt Seal Included</p>  <p>Overall Height: 16.44 (417) Fin Diameter: 15.80 (401) End 2 OD: 12.09 (307) End 1 ID: 7.73 (196) End 2 ID: 0.67 (17)</p>
<p>AF459 FARR P48 (6 x 8) Inside-Out Flow</p>  <p>Height: 8.18 (208) Length: 19.81 (503) Width: 15.19 (386)</p>	<p>AF471 FIAT-ALLIS 70197588 Safety Element used with AF4506M, AF472 For Outer Air use AF472 or AF4506M depending on the application. For Magnum Version use AF471M. 3311624 Bolt Seal Included</p>  <p>Overall Height: 17.73 (450) End 1 OD: 8.43 (214) End 2 OD: 7.26 (185) End 1 ID: 6.23 (158) End 2 ID: 0.67 (17)</p>	<p>AF474M DONALDSON P117185 3311624 Bolt Seal Included</p>  <p>Overall Height: 16.44 (417) Fin Diameter: 15.80 (401) End 2 OD: 12.09 (307) End 1 ID: 7.73 (196) End 2 ID: 0.67 (17)</p>
<p>AF460 FARR P64 (8 x 8) Inside-Out Flow</p>  <p>Height: 8.18 (208) Length: 19.81 (503) Width: 19.81 (503)</p>	<p>AF471M DONALDSON P119372 Extended Life Version of AF471. 3311624 Bolt Seal Incl.</p>  <p>Overall Height: 17.73 (450) End 1 OD: 8.43 (214) End 2 OD: 7.26 (185) End 1 ID: 6.23 (158) End 2 ID: 0.67 (17)</p>	<p>AF476K FORD D0HZ9601A For Magnum Version use AF476KM. 3311624 Bolt Seal Included</p>  <p>Overall Height: 16.50 (419) Fin Diameter: 13.80 (351) End 2 OD: 11.08 (281) End 1 ID: 0.67 (17) End 2 ID: 6.73 (171)</p>
<p>AF461 CASE 317702R91</p>  <p>Overall Height: 12.62 (321) Overall OD: 4.49 (114) End 1 ID: 2.26 (58)</p>	<p>AF472 Primary Air Filter used with AF471 For Magnum Version use AF472M. 3311624 Bolt Seal Included</p>  <p>Overall Height: 18.49 (470) Overall OD: 12.08 (307) End 1 ID: 7.72 (196) End 2 ID: 0.67 (17)</p>	<p>AF476KM DONALDSON P119114 Extended Life Version of AF476K. 3311624 Bolt Seal Included</p>  <p>Overall Height: 16.50 (419) Fin Diameter: 13.80 (351) End 2 OD: 11.08 (281) End 1 ID: 0.67 (17) End 2 ID: 6.73 (171)</p>
<p>AF462K FORD D0HZ9601B For Magnum Version use AF462KM. 3311624 Bolt Seal Included</p>  <p>Overall Height: 10.62 (270) Fin Diameter: 13.80 (351) End 2 OD: 11.08 (281) End 1 ID: 0.67 (17) End 2 ID: 6.73 (171)</p>	<p>AF472M Primary Air Filter used with AF471 For Magnum Version use AF472M. 3311624 Bolt Seal Included</p>  <p>Overall Height: 18.49 (470) Overall OD: 12.08 (307) End 1 ID: 7.72 (196) End 2 ID: 0.67 (17)</p>	<p>AF476M Primary Air Filter used with AF471 For Magnum Version use AF476M. 3311624 Bolt Seal Included</p>  <p>Overall Height: 18.49 (470) Overall OD: 12.08 (307) End 1 ID: 7.72 (196) End 2 ID: 0.67 (17)</p>

E. PRODUCT GUIDE

AF477K FORD C8HZ9601A For Magnum Version use AF477KM. 3311624 Bolt Seal Included



Overall Height: 8.57 (218)
 Fin Diameter: 11.70 (297)
 End 2 OD: 9.21 (234)
 End 1 ID: 0.67 (17)
 End 2 ID: 4.86 (123)

AF477KM DONALDSON P119183, DONALDSON XLP182024 For Magnum Version use AF477K 3311624 Bolt Seal Included



Overall Height: 8.57 (218)
 Fin Diameter: 11.70 (297)
 End 2 OD: 9.21 (234)
 End 1 ID: 0.67 (17)
 End 2 ID: 4.86 (123)

AF478K For Magnum Version use AF478KM



Overall Height: 10.50 (267)
 Fin Diameter: 15.80 (401)
 End 2 OD: 12.08 (307)
 End 1 ID: 0.67 (17)
 End 2 ID: 7.73 (196)

AF478KM DONALDSON P127918 Extended Life Version of AF478K



Overall Height: 10.50 (267)
 Fin Diameter: 15.80 (401)
 End 2 OD: 12.08 (307)
 End 1 ID: 0.67 (17)
 End 2 ID: 7.73 (196)

AF479 TOYOTA 1780124010

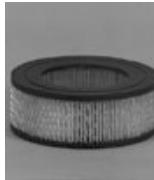

Overall Height: 2.76 (70)
 Overall OD: 7.12 (181)
 End 1 ID: 4.94 (125)

AF484 TOYOTA 1780131010



Overall Height: 2.27 (58)
 Overall OD: 9.69 (246)
 End 1 ID: 6.94 (176)

AF485 TOYOTA 1780141050



Overall Height: 1.95 (50)
 Overall OD: 12.25 (311)
 End 1 ID: 9.38 (238)

AF486K JOHN DEERE AR45784 3311624 Bolt Seal Included



Overall Height: 16.55 (420)
 Fin Diameter: 10.70 (272)
 End 2 OD: 7.93 (201)
 End 1 ID: 5.33 (135)
 End 2 ID: 0.67 (17)

AF487 JOHN DEERE AT27823 Safety Element used with AF1917M, AF4541KM, AF489K, AF932 . 3311624 Bolt Seal Included



Overall Height: 11.23 (285)
 End 1 OD: 0.67 (17)
 End 2 OD: 4.62 (117)
 End 1 ID: 3.51 (89)

AF488 JOHN DEERE AR45785 Safety Element used with AF1732K . 3311624 Bolt Seal Incl.



Overall Height: 11.23 (285)
 End 1 OD: 0.67 (17)
 End 2 OD: 5.21 (132)
 End 1 ID: 4.16 (106)
 End 2 ID: 5.21 (132)

AF489K JOHN DEERE AT27824 Primary Air Filter used with AF487 For element w/o fin use AF418. 3311624 Bolt Seal Included



Overall Height: 13.38 (340)
 Fin Diameter: 11.70 (297)
 End 2 OD: 9.21 (234)
 End 1 ID: 4.86 (123)
 End 2 ID: 0.67 (17)

AF490M FIAT-ALLIS 70662609, JOHN DEERE AR46004, FRANKLIN 1513160 Safety Element used with AF418, AF4567, AF418M Filter used with AH19070 . 3311624 Bolt Seal Included



Overall Height: 13.05 (332)
 End 1 OD: 5.80 (147)
 End 2 OD: 4.61 (117)
 End 1 ID: 3.56 (90)
 End 2 ID: 0.67 (17)

AF491 FORD D2AZ9601A

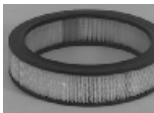

Overall Height: 2.61 (66)
 Overall OD: 11.22 (285)
 End 1 ID: 9.03 (229)

AF492 ALLIS-CHALMERS 7237395, CASE 313964R91 Primary Air Filter used with AF1687



Overall Height: 10.87 (276)
 Overall OD: 4.49 (114)
 End 1 ID: 2.26 (58)

AF493 CASE 391852R91



Overall Height: 10.78 (274)
 End 1 OD: 3.56 (90)
 End 2 OD: 3.52 (89)
 End 1 ID: 2.07 (53)
 End 2 ID: 2.24 (57)

AF494 CASE 338744R91, GMC 6485497, KOMATSU 338744R91



Overall Height: 17.32 (440)
 End 1 OD: 5.55 (141)
 End 2 OD: 5.53 (140)
 End 1 ID: 3.17 (80)

AF498 CATERPILLAR 4S8340 Safety Element used with AF801 Fleetguard Airtkit Option AF4514 + AK00005



Overall Height: 13.38 (340)
 Flange Diameter: 10.20 (259)
 End 2 OD: 7.66 (195)
 End 1 ID: 6.00 (152)

AF800 CATERPILLAR 3S4745 Safety Element used with AF803 Fleetguard Airtkit Option AF4516 + AK00008



Overall Height: 15.28 (388)
 Flange Diameter: 12.00 (305)
 End 2 OD: 8.66 (220)
 End 1 ID: 7.00 (178)

AF801 CATERPILLAR 4S8337 Primary Air Filter used with AF498



Overall Height: 14.48 (368)
 End 1 OD: 14.40 (366)
 End 2 OD: 12.77 (324)
 End 1 ID: 0.93 (23)
 End 2 ID: 8.36 (212)

AF802 CATERPILLAR 4S8833



Overall Height: 9.80 (249)
 End 1 OD: 14.40 (366)
 End 2 OD: 12.77 (324)
 End 1 ID: 0.93 (23)
 End 2 ID: 8.36 (212)

AF803 CATERPILLAR 5S4282 Primary Air Filter used with AF800



Gasket: 3309167 (1)
 Overall Height: 16.15 (410)
 End 1 OD: 16.40 (417)
 End 2 OD: 13.83 (351)
 End 1 ID: 0.93 (23)
 End 2 ID: 9.48 (241)

AF804M Safety Element used with AF1929, AF434KM Filter used with AH19068 . 3311624 Bolt Seal Included



Overall Height: 15.71 (399)
 End 1 OD: 5.81 (148)
 End 2 OD: 4.61 (117)
 End 1 ID: 3.51 (89)
 End 2 ID: 0.67 (17)

AF805K CASE 381344R91, CASE 381344R92 . 3311624 Bolt Seal Included













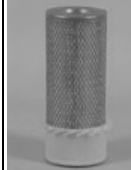









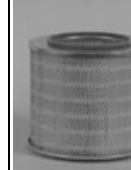

Overall Height: 10.10 (256)
 Fin Diameter: 6.40 (163)
 End 2 OD: 5.24 (133)
 End 1 ID: 2.71 (69)
 End 2 ID: 0.67 (17)

AF806K CASE 675410R91 3311624 Bolt Seal Included

















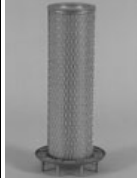







Overall Height: 7.25 (184)
 Fin Diameter: 6.40 (163)
 End 2 OD: 5.24 (133)
 End 1 ID: 2.71 (69)
 End 2 ID: 0.67 (17)







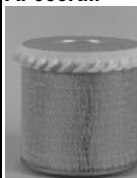













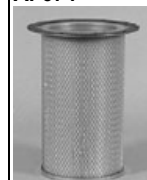

E. PRODUCT GUIDE

AF807K  CASE 384812R93 3311624 Bolt Seal Included Overall Height: 11.25 (286) Fin Diameter: 8.03 (204) End 2 OD: 5.24 (133) End 1 ID: 2.71 (69) End 2 ID: 0.64 (16)	AF816K  CASE A42224 3311624 Bolt Seal Included Overall Height: 13.25 (337) Fin Diameter: 6.40 (163) End 2 OD: 5.24 (133) End 1 ID: 2.71 (69) End 2 ID: 0.67 (17)	AF824K  ALLIS-CHALMERS 2565687 250806 Bolt Seal Included Overall Height: 9.50 (241) Fin Diameter: 10.70 (272) End 2 OD: 7.93 (201) End 1 ID: 3.58 (91) End 2 ID: 0.54 (14)
AF808K  CASE 383731R93 3311624 Bolt Seal Included Overall Height: 14.30 (363) Fin Diameter: 6.40 (163) End 2 OD: 5.24 (133) End 1 ID: 2.71 (69) End 2 ID: 0.67 (17)	AF817K  JOHN DEERE AH19848 3311624 Bolt Seal Incl. Overall Height: 9.25 (235) Fin Diameter: 6.40 (163) End 2 OD: 5.24 (133) End 1 ID: 2.71 (69) End 2 ID: 0.67 (17)	AF825  CASE A17742, GMC 6484156 Safety Element used with AF827 Overall Height: 9.52 (242) Overall OD: 6.83 (174) End 1 ID: 4.23 (107)
AF809K  CASE 343731R91 250806 Bolt Seal Included Overall Height: 16.50 (419) Fin Diameter: 10.70 (272) End 2 OD: 7.93 (201) End 1 ID: 3.58 (91) End 2 ID: 0.54 (14)	AF818K  JOHN DEERE AR39798 Primary Air Filter used with AF4817 3311624 Bolt Seal Included Overall Height: 10.38 (264) Fin Diameter: 7.80 (198) End 2 OD: 6.08 (154) End 1 ID: 3.48 (88) End 2 ID: 0.67 (17)	AF826  CASE A14417 Overall Height: 8.54 (217) Overall OD: 10.21 (259) End 1 ID: 5.54 (141)
AF810K  CASE 392517R91 Primary Air Filter used with AF815 Overall Height: 14.39 (366) Fin Diameter: 10.70 (272) End 2 OD: 7.95 (202) End 1 ID: 5.33 (135)	AF819KM  DONALDSON P108736 3311624 Bolt Seal Incl. Overall Height: 9.41 (239) Fin Diameter: 5.16 (131) End 2 OD: 4.08 (104) End 1 ID: 2.56 (65) End 2 ID: 0.67 (17)	AF827  CASE A17741 Primary Air Filter used with AF825 Overall Height: 10.79 (274) Overall OD: 11.94 (303) End 1 ID: 7.32 (186)
AF811  FARR R150 Height: 14.00 (356) Length: 22.88 (581) Width: 6.19 (157)	AF820M  JOHN DEERE U44956 Safety Element used with AF424, AF25284M, AF4583M, AF25249M Filter used with AH19072 . 3311624 Bolt Seal Incl. Overall Height: 16.13 (410) End 1 OD: 7.59 (193) End 2 OD: 6.40 (163) End 1 ID: 5.28 (134) End 2 ID: 0.67 (17)	AF828  JOHN DEERE AT25219 Safety Element used with AF945K 3311624 Bolt Seal Included Overall Height: 7.46 (189) Overall OD: 4.08 (104) End 1 ID: 2.56 (65) End 2 ID: 0.67 (17)
AF813  CASE 383732R93 3311624 Bolt Seal Incl. Overall Height: 11.31 (287) End 1 OD: 6.10 (155) End 2 OD: 6.08 (154) End 1 ID: 0.67 (17) End 2 ID: 3.48 (88)	AF821M  CAMECO INDUSTRIES 60034315 Safety Element used with AF421M 3830497 Bolt Seal Included Overall Height: 15.40 (391) End 1 OD: 7.65 (194) End 2 OD: 7.64 (194) End 1 ID: 0.88 (22) End 2 ID: 6.05 (154)	AF829  JOHN DEERE AR46481 3311624 Bolt Seal Included Overall Height: 12.31 (313) End 1 OD: 6.10 (155) End 2 OD: 6.08 (154) End 1 ID: 0.67 (17) End 2 ID: 3.48 (88)
AF814  CASE 383711R93 3311624 Bolt Seal Incl. Overall Height: 16.31 (414) End 1 OD: 6.10 (155) End 2 OD: 6.08 (154) End 1 ID: 0.67 (17) End 2 ID: 3.48 (88)	AF822M  DONALDSON P119371 Safety Element used with AF427M 3830497 Bolt Seal Included Overall Height: 12.44 (316) Overall OD: 5.96 (151) End 1 ID: 4.85 (123) End 2 ID: 0.87 (22)	AF830  JOHN DEERE AR46976 3311624 Bolt Seal Included Overall Height: 14.51 (369) End 1 OD: 6.85 (174) End 2 OD: 6.83 (174) End 1 ID: 0.68 (17) End 2 ID: 3.48 (88)
AF815  CASE 392516R91 Safety Element used with AF810K 3311624 Bolt Seal Incl. Overall Height: 13.28 (337) End 1 OD: 0.67 (17) End 2 OD: 5.21 (132) End 1 ID: 4.16 (106) End 2 ID: 5.21 (132)	AF823KM  DONALDSON P114207 3311624 Bolt Seal Included Overall Height: 5.32 (135) Fin Diameter: 11.70 (297) End 2 OD: 9.21 (234) End 1 ID: 0.67 (17) End 2 ID: 4.86 (123)	AF833  CASE 390642R91 Primary Air Filter used with AF848 Overall Height: 16.50 (419) Overall OD: 9.21 (234) End 1 ID: 4.86 (123)

E. PRODUCT GUIDE

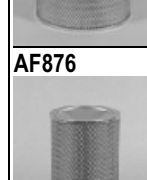
<p>AF834K CASE 537336R1</p>  <p>Overall Height: 15.49 (393) Fin Diameter: 10.70 (272) End 2 OD: 7.95 (202) End 1 ID: 5.33 (135)</p>	<p>AF846 CASE 401269R1 Primary Air Filter used with AF844</p>  <p>Overall Height: 12.87 (327) Overall OD: 6.63 (168) End 1 ID: 4.19 (106)</p>	<p>AF852M DONALDSON P116918, DONALDSON XLP182008 Uses service part: 3301159S, 3312554S, 3317765S Extended Life Version of AF852</p>  <p>Overall Height: 23.00 (584) End 1 OD: 12.77 (324) End 1 ID: 8.36 (212) End 2 ID: 12.73 (323)</p>
<p>AF835K ALLIS-CHALMERS 239622, CASE A59586 3311624 Bolt Seal Incl.</p>  <p>Overall Height: 14.38 (365) Fin Diameter: 7.80 (198) End 2 OD: 6.08 (154) End 1 ID: 3.48 (88) End 2 ID: 0.67 (17)</p>	<p>AF847 CASE 401270R1 Primary Air Filter used with AF845</p>  <p>Overall Height: 15.37 (391) End 1 OD: 6.88 (175) End 2 OD: 6.63 (168) End 1 ID: 4.19 (106)</p>	<p>AF853 DONALDSON P134743, DONALDSON SMP181007 Uses service part: 3312556S</p>  <p>Overall Height: 22.36 (568) Overall OD: 10.39 (264)</p>
<p>AF839 WHITE 3108661 250806 Bolt Seal Included</p>  <p>Overall Height: 15.50 (394) End 1 OD: 9.63 (245) End 2 OD: 9.18 (233) End 1 ID: 4.04 (103) End 2 ID: 0.40 (10)</p>	<p>AF848 CASE 390643R91 Safety Element used with AF833</p>  <p>Overall Height: 15.84 (402) Flange Diameter: 7.00 (178) End 2 OD: 4.61 (117) End 1 ID: 3.44 (87)</p>	<p>AF853M DONALDSON P117797 Uses service part: 3312556S Optional Cover Gasket: Extended Life Version of AF853</p>  <p>Overall Height: 22.37 (568) End 1 OD: 10.40 (264) End 2 OD: 10.00 (254) End 1 ID: 6.05 (154)</p>
<p>AF841 WHITE 3107025 250806 Bolt Seal Included</p>  <p>Overall Height: 12.75 (324) End 1 OD: 11.18 (284) End 2 OD: 10.74 (273) End 1 ID: 0.40 (10) End 2 ID: 5.62 (143)</p>	<p>AF849 WHITE 27074664, FARR T519 Single Inlet Also See AF850</p>  <p>Height: 5.00 (127) Length: 19.00 (483) Width: 19.00 (483)</p>	<p>AF854K DONALDSON P118675 250806 Bolt Seal Included</p>  <p>Overall Height: 15.56 (395) Fin Diameter: 15.70 (399) End 2 OD: 12.08 (307) End 1 ID: 0.54 (14) End 2 ID: 7.73 (196)</p>
<p>AF842 CASE 619652C1 250806 Bolt Seal Included</p>  <p>Overall Height: 13.16 (334) Overall OD: 10.02 (255) End 1 ID: 5.48 (139) End 2 ID: 0.40 (10)</p>	<p>AF850 FARR T519D Dual Inlet Also See AF849</p>  <p>Height: 5.00 (127) Length: 19.00 (483) Width: 19.00 (483)</p>	<p>AF855M DONALDSON P119587</p>  <p>Overall Height: 18.05 (458) Overall OD: 10.40 (264) End 1 ID: 6.05 (154)</p>
<p>AF843 CASE 385168R1</p>  <p>Overall Height: 1.95 (50) Overall OD: 6.07 (154) End 1 ID: 4.68 (119)</p>	<p>AF851M DONALDSON P117441 Primary Air Filter used with AF883M, AF943 For Inner Air use AF883M or AF943 depending on application. 256282 Bolt Seal Included</p>  <p>Overall Height: 18.49 (470) Overall OD: 13.83 (351) End 1 ID: 9.48 (241) End 2 ID: 0.91 (23)</p>	<p>AF856M WHITE 27000805, CASE 447417C1 311624 Bolt Seal Included</p>  <p>Overall Height: 19.99 (508) Overall OD: 12.08 (307) End 1 ID: 7.73 (196) End 2 ID: 0.67 (17)</p>
<p>AF844 CASE 401267R1 Safety Element used with AF846</p>  <p>Overall Height: 12.31 (313) Overall OD: 4.12 (105) End 1 ID: 0.44 (11) End 2 ID: 3.00 (76)</p>	<p>AF852 MACK 57MD33 Uses service part: 3312554S, 3317765S Optional Cover Gaskets: Donaldson Hsg. 3312554S Fram Hsg. 3317765S For Magnum Version use AF852M</p>  <p>Overall Height: 23.00 (584) End 1 OD: 12.77 (324) End 1 ID: 8.36 (212)</p>	<p>AF857 DONALDSON P115070 Safety Element used with AF879, AF879M 3830497 Bolt Seal Included</p>  <p>Overall Height: 22.15 (563) Overall OD: 10.88 (276) End 1 ID: 8.16 (207) End 2 ID: 0.90 (23)</p>
<p>AF845 CASE 401268R1 Safety Element used with AF847</p>  <p>Overall Height: 14.50 (368) Overall OD: 4.12 (105) End 1 ID: 0.41 (10) End 2 ID: 3.00 (76)</p>	<p>AF858KM WHITE 27077560 311624 Bolt Seal Included</p>  <p>Overall Height: 12.62 (321) Fin Diameter: 13.80 (351) End 2 OD: 12.10 (307) End 1 ID: 0.67 (17) End 2 ID: 5.69 (145)</p>	<p>AF858KM WHITE 27077560 311624 Bolt Seal Included</p>  <p>Overall Height: 12.62 (321) Fin Diameter: 13.80 (351) End 2 OD: 12.10 (307) End 1 ID: 0.67 (17) End 2 ID: 5.69 (145)</p>

E. PRODUCT GUIDE

<p>AF859KM WHITE 27077372 311624 Bolt Seal Included</p>  <p>Overall Height: 10.56 (268) Fin Diameter: 15.50 (394) End 2 OD: 13.85 (352) End 1 ID: 0.67 (17) End 2 ID: 7.44 (189)</p>	<p>AF865 DONALDSON P134745 Uses service part: 3301159S For Magnum Version use AF865M</p>  <p>Gasket: 3312554 Overall Height: 27.00 (686) Overall OD: 12.77 (324) End 1 ID: 8.36 (212)</p>	<p>AF872 CASE 420051C1 Filter used with AH19327 For Upgrade, use AF872M</p>  <p>Overall Height: 18.48 (469) Cover Diameter: 16.41 (417) End 2 OD: 13.83 (351) End 2 ID: 9.48 (241)</p>
<p>AF860 DONALDSON SMP181010 For Magnum Version use AF860M 3311624 Bolt Seal Included</p>  <p>Overall Height: 14.51 (368) End 1 OD: 12.10 (307) End 1 ID: 5.69 (145) End 2 ID: 0.67 (17)</p>	<p>AF865M DONALDSON P128299 Extended Life Version of AF865</p>  <p>Overall Height: 27.00 (686) Overall OD: 12.77 (324) End 1 ID: 10.09 (256)</p>	<p>AF872M DONALDSON P118047, DONALDSON XLP182006 Upgrade of AF872 For Magnum Version use AF872M</p>  <p>Overall Height: 18.48 (469) Cover Diameter: 16.41 (417) End 2 OD: 13.83 (351) End 2 ID: 9.48 (241)</p>
<p>AF860M DONALDSON XLP182010 Extended Life Version of AF860 3311624 Bolt Seal Included</p>  <p>Overall Height: 14.48 (368) End 1 OD: 12.10 (307) End 1 ID: 5.69 (145) End 2 ID: 0.67 (17)</p>	<p>AF867M CASE 472099C1 3311624 Bolt Seal Included</p>  <p>Overall Height: 17.77 (451) End 1 OD: 12.10 (307) End 1 ID: 5.69 (145) End 2 ID: 0.67 (17)</p>	<p>AF873M CATERPILLAR 1P8483 Primary Air Filter used with AF1833, AF874</p>  <p>Overall Height: 15.47 (393) End 1 OD: 12.49 (317) End 2 ID: 9.11 (231)</p>
<p>AF861M DONALDSON P121075</p>  <p>Gasket: 3309167 (1), 3311624(1) Overall Height: 18.62 (473) End 1 OD: 13.85 (352) End 1 ID: 7.44 (189) End 2 ID: 0.67 (17)</p>	<p>AF869M CASE 606860C91 Primary Air Filter used with AF1654</p>  <p>Overall Height: 18.49 (470) Overall OD: 9.21 (234) End 1 ID: 4.86 (123)</p>	<p>AF874 CATERPILLAR 1P8482 Safety Element used with AF873M For Magnum Version use AF874M Fleetguard Airkit Option AF4516 + AK0007</p>  <p>Overall Height: 15.03 (382) End 1 OD: 11.40 (289) End 2 OD: 8.63 (219) End 1 ID: 7.00 (178)</p>
<p>AF862KM WHITE 27077288 3311624 Bolt Seal Included</p>  <p>Overall Height: 12.60 (320) Fin Diameter: 15.50 (394) End 2 OD: 13.85 (352) End 1 ID: 0.67 (17) End 2 ID: 7.44 (189)</p>	<p>AF870 WHITE 27092086 For Magnum Version use AF870M</p>  <p>Overall Height: 19.42 (493) End 1 OD: 16.26 (413) End 2 OD: 12.75 (324) End 2 ID: 7.36 (187)</p>	<p>AF874M CATERPILLAR 7N1308 Extended Life Version of AF874 Fleetguard Air kit Option AF4516M + AK00007</p>  <p>Overall Height: 15.03 (382) End 1 OD: 11.40 (289) End 2 OD: 8.63 (219) End 1 ID: 7.00 (178)</p>
<p>AF863M DONALDSON P117092</p>  <p>Gasket: 3312554 Overall Height: 21.00 (533) End 1 OD: 12.79 (325) End 2 OD: 12.77 (324) End 2 ID: 8.36 (212)</p>	<p>AF870M DONALDSON P122079 Extended Life Version of AF870</p>  <p>Overall Height: 19.42 (493) End 1 OD: 16.26 (413) End 2 OD: 12.75 (324) End 2 ID: 7.36 (187)</p>	<p>AF875M CATERPILLAR 1P7716 Primary Air Filter used with AF876</p>  <p>Overall Height: 13.51 (343) Overall OD: 11.50 (292) End 1 ID: 8.08 (205)</p>
<p>AF864 DONALDSON P119297 For Upgrade, use AF864M For Magnum Version use AF864M 3830497 Bolt Seal Included</p>  <p>Gasket: 3830497 Overall Height: 7.69 (195) Overall OD: 17.60 (447) End 1 ID: 11.10 (282) End 2 ID: 0.90 (23)</p>	<p>AF871 CASE 425534C1 For Magnum Version use AF871M</p>  <p>Overall Height: 21.52 (547) End 1 OD: 16.26 (413) End 2 OD: 13.83 (351) End 2 ID: 9.48 (241)</p>	<p>AF876 CATERPILLAR 1P7360 Safety Element used with AF875M Fleetguard Airkit Option AF4514 + AK00005</p>  <p>Overall Height: 13.50 (343) Flange Diameter: 10.25 (260) End 2 OD: 7.62 (194) End 1 ID: 6.00 (152) End 2 ID: 1.72 (44)</p>
<p>AF864M DONALDSON P124307 Upgrade of AF864 3830497 Bolt Seal Included</p>  <p>Gasket: 3830497 Overall Height: 7.69 (195) Overall OD: 17.60 (447) End 1 ID: 11.10 (282) End 2 ID: 0.90 (23)</p>	<p>AF871M DONALDSON P118039 Extended Life Version of AF871</p>  <p>Overall Height: 21.52 (547) End 1 OD: 16.26 (413) End 2 OD: 13.83 (351) End 2 ID: 9.48 (241)</p>	<p>AF877M DONALDSON P124726</p>  <p>Overall Height: 19.77 (502) Overall OD: 10.40 (264) End 1 ID: 6.05 (154)</p>

E. PRODUCT GUIDE

AF878M DONALDSON P124907



Overall Height: 17.93 (455)
Overall OD: 12.77 (324)
End 1 ID: 8.36 (212)

AF879 WABCO VS2186 Primary Air Filter used with AF857 For Upgrade, use AF879M 3630497 Bolt Seal Included



Gasket: 3308026
Overall Height: 23.62 (600)
Boot Diameter: 18.60 (472)
End 2 OD: 17.60 (447)
End 1 ID: 0.90 (23)
End 2 ID: 11.10 (282)

AF879M DONALDSON P115069, DONALDSON XLP182038 Primary Air Filter used with AF857 Upgrade of AF879 3830497 Bolt Seal Included



Gasket: 3308026
Overall Height: 23.62 (600)
End 1 OD: 18.43 (468)
End 2 OD: 17.64 (448)
End 1 ID: 0.91 (23)
End 2 ID: 11.12 (283)

AF880 WABCO VJ5176 Safety Element used with AF899, AF899M 3830497 Bolt Seal Included



Overall Height: 22.50 (572)
End 1 OD: 11.92 (303)
End 1 ID: 10.22 (259)
End 2 ID: 0.90 (23)

AF881 FIAT-ALLIS 70690304, DRESSTA 1200455H1 Safety Element used with AF882M, AF1849M 3830497 Bolt Seal Included



Overall Height: 21.13 (537)
End 1 OD: 0.90 (23)
End 2 OD: 8.63 (219)
End 1 ID: 7.11 (181)

AF882M FIAT-ALLIS 70690305 Primary Air Filter used with AF881 3830497 Bolt Seal Included



Overall Height: 22.68 (576)
End 1 OD: 14.60 (371)
End 2 OD: 13.83 (351)
End 1 ID: 0.90 (23)
End 2 ID: 9.48 (241)

AF883M EUCLID 9035993 Safety Element used with AF4606M, AF851M Extended Life Version of AF883. 3830497 Bolt Seal Included



Gasket: 3830497
Overall Height: 17.11 (435)
Overall OD: 8.63 (219)
End 1 ID: 7.05 (179)
End 2 ID: 0.91 (23)

AF884K JOY 1224974 3311624 Bolt Seal Included



Overall Height: 18.55 (471)
Fin Diameter: 15.80 (401)
End 2 OD: 12.08 (307)
End 1 ID: 0.67 (17)
End 2 ID: 7.73 (196)

AF885M FORD D5HZ9601C



Overall Height: 20.96 (532)
Overall OD: 10.40 (264)
End 1 ID: 6.05 (154)

AF886 FORD D5HZ9601D For Magnum Version use AF886M



Gasket: 3312556
Overall Height: 16.00 (406)
End 1 OD: 10.40 (264)
End 1 ID: 6.05 (154)

AF886M DONALDSON XLP182014 Extended Life Version Of AF886



Gasket: 3312556
Overall Height: 16.00 (406)
End 1 OD: 10.40 (264)
End 1 ID: 6.05 (154)

AF887KM DONALDSON P120117, LUBERFINER LAF1868, CHAMP LAF1868 250806 Bolt Seal Included



Overall Height: 14.56 (370)
Fin Diameter: 15.85 (402)
End 1 ID: 9.48 (241)
End 2 ID: 0.54 (14)

AF888M WHITE 27088627 3830497 Bolt Seal Included



Overall Height: 17.64 (448)
Boot Diameter: 13.50 (343)
End 2 OD: 12.77 (324)
End 1 ID: 0.93 (23)
End 2 ID: 8.36 (212)

AF889 NEW HOLLAND 614104, IHC HOUSINGS 923611C91 Safety Element used with AF901 3311624 Bolt Seal Included



Overall Height: 20.05 (509)
End 1 OD: 0.67 (17)
End 2 OD: 6.41 (163)
End 1 ID: 5.27 (134)
End 2 ID: 6.40 (163)

AF890 INGERSOLL-RAND 35123520 Safety Element used with AF891 3830497 Bolt Seal Included



Overall Height: 22.44 (570)
Overall OD: 8.24 (209)
End 1 ID: 7.12 (181)
End 2 ID: 0.93 (24)

AF891 DONALDSON P145706 Primary Air Filter used with AF890 For Magnum Version use AF891M 3830497 Bolt Seal Included



Overall Height: 24.65 (626)
End 1 OD: 13.80 (351)
End 2 OD: 12.77 (324)
End 1 ID: 0.93 (23)
End 2 ID: 8.36 (212)

AF891M INGERSOLL-RAND 35123512 3830497 Bolt Seal Included



Overall Height: 24.62 (625)
End 1 OD: 13.80 (351)
End 2 OD: 12.77 (324)
End 1 ID: 0.93 (24)
End 2 ID: 8.36 (212)

AF892 AC A866C Safety Element used with AF893 250806 Bolt Seal Included



Overall Height: 13.55 (344)
Overall OD: 5.07 (129)
End 1 ID: 3.83 (97)
End 2 ID: 0.42 (11)

AF893 KOMATSU 6112837610 Primary Air Filter used with AF892 250806 Bolt Seal Included



Overall Height: 15.57 (395)
Overall OD: 9.65 (245)
End 1 ID: 5.25 (133)
End 2 ID: 0.42 (11)

AF894 KOMATSU 6001819120 Safety Element used with AF895



Overall Height: 11.72 (298)
End 1 OD: 0.63 (16)
End 2 OD: 4.10 (104)
End 1 ID: 2.92 (74)
End 2 ID: 4.10 (104)

AF895 KOMATSU 6001819220 Primary Air Filter used with AF894



Overall Height: 12.94 (329)
End 1 OD: 8.27 (210)
End 2 OD: 8.26 (210)
End 1 ID: 0.40 (10)
End 2 ID: 4.17 (106)

AF896 KOMATSU 6003000121 Safety Element used with AF897



























Overall Height: 16.86 (428)
Flange Diameter: 6.72 (171)
End 2 OD: 4.13 (105)
End 1 ID: 2.84 (72)

AF897 KOMATSU 6003000110 Primary Air Filter used with AF896























Overall Height: 16.81 (427)
Overall OD: 8.48 (215)
End 1 ID: 4.17 (106)











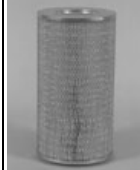





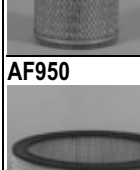

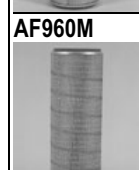

E. PRODUCT GUIDE

<p>AF898M CASE 433324C1 IH 1600-1800 Trucks w/ Dd 6V-53</p>  <p>Overall Height: 7.54 (192) End 1 OD: 16.26 (413) End 2 OD: 13.85 (352) End 2 ID: 7.44 (189)</p>	<p>AF904 CASE 627934C1 Primary Air Filter used with AF905 3311624 Bolt Seal Included</p>  <p>Overall Height: 12.50 (318) Overall OD: 10.40 (264) End 1 ID: 6.05 (154) End 2 ID: 0.68 (17)</p>	<p>AF911 MACK 57MD31 For Magnum Version use AF911M</p>  <p>Gasket: 3312554 Overall Height: 15.00 (381) Overall OD: 12.77 (324) End 1 ID: 8.36 (212)</p>
<p>AF899 DONALDSON SMP181040, WABCO VJ0075, WABCO VJ5175 Primary Air Filter used with AF880 For Magnum Version use AF899M. 3830497 Bolt Seal Included</p>  <p>Gasket: 3825893 Overall Height: 23.62 (600) End 1 OD: 18.60 (472) End 2 OD: 17.60 (447) End 1 ID: 0.90 (23) End 2 ID: 12.23 (311)</p>	<p>AF905 CASE A47146 Safety Element used with AF4636, AF904 3311624 Bolt Seal Included</p>  <p>Overall Height: 10.44 (265) End 1 OD: 5.97 (152) End 1 ID: 4.83 (123)</p>	<p>AF911M DONALDSON P142448 Extended Life Version of AF911</p>  <p>Gasket: 3312554 Overall Height: 15.00 (381) Overall OD: 12.77 (324) End 1 ID: 8.36 (212)</p>
<p>AF899M WABCO VJ0075, WABCO VJ5175 Primary Air Filter used with AF880 Extended Life Version of AF899. 3830497 Bolt Seal Included</p>  <p>Gasket: 3825893 Overall Height: 23.62 (600) Boot Diameter: 18.60 (472) End 2 OD: 17.60 (447) End 1 ID: 0.90 (23) End 2 ID: 12.23 (311)</p>	<p>AF906 CASE 627127C1 Primary Air Filter used with AF907 3830497 Bolt Seal Included</p>  <p>Overall Height: 16.60 (422) Boot Diameter: 11.40 (290) End 2 OD: 10.40 (264) End 1 ID: 0.90 (23) End 2 ID: 6.05 (154)</p>	<p>AF915 VERSATILE 22935 Safety Element used with AF916</p>  <p>Overall Height: 18.32 (465) End 1 OD: 0.55 (14) End 2 OD: 7.06 (179) End 2 ID: 5.85 (149)</p>
<p>AF900 CASE 702848C1 Primary Air Filter used with AF902</p>  <p>Overall Height: 23.00 (584) Overall OD: 8.50 (216) End 1 ID: 5.39 (137) End 2 ID: 0.44 (11)</p>	<p>AF907 JOHN DEERE AE30507, CASE 624978C91 Safety Element used with AF1887M, AF906 3830497 Bolt Seal Included</p>  <p>Overall Height: 14.35 (364) End 1 OD: 0.88 (22) End 2 OD: 5.98 (152) End 1 ID: 4.83 (123) End 2 ID: 5.96 (151)</p>	<p>AF916 VERSATILE 22934 Primary Air Filter used with AF915</p>  <p>Overall Height: 20.37 (517) Cover Diameter: 13.91 (353) End 2 ID: 7.73 (196)</p>
<p>AF901 IHC HOUSINGS 640968C91, JOHN DEERE AT49022, NEW HOLLAND 614103 Primary Air Filter used with AF889 3311624 Bolt Seal Included</p>  <p>Overall Height: 20.45 (519) End 1 OD: 11.09 (282) End 1 ID: 0.67 (17) End 2 ID: 6.73 (171)</p>	<p>AF908 CASE 702672C1 Primary Air Filter used with AF909 3302302 Bolt Seal Included</p>  <p>Overall Height: 27.41 (696) Overall OD: 12.56 (319) End 1 ID: 7.57 (192) End 2 ID: 0.77 (20)</p>	<p>AF917 VERSATILE 22930 Primary Air Filter used with AF918</p>  <p>Overall Height: 20.47 (520) Overall OD: 10.47 (266) End 1 ID: 6.88 (175)</p>
<p>AF902 CASE 702847C1 Safety Element used with AF900 3311624 Bolt Seal Included</p>  <p>Overall Height: 21.46 (545) End 1 OD: 0.68 (17) End 2 OD: 5.26 (134) End 1 ID: 4.16 (106) End 2 ID: 5.21 (132)</p>	<p>AF909 CASE 702673C1 Safety Element used with AF908 3302302 Bolt Seal Included</p>  <p>Overall Height: 25.72 (653) End 1 OD: 6.16 (156) End 2 OD: 7.35 (187) End 1 ID: 6.16 (156) End 2 ID: 7.35 (187)</p>	<p>AF918 VERSATILE 17444 Safety Element used with AF917, AF927</p>  <p>Overall Height: 18.42 (468) End 1 OD: 6.13 (156) End 1 ID: 0.50 (13) End 2 ID: 4.73 (120)</p>
<p>AF903M CUMMINS 3013205 3311624 Bolt Seal Included</p>  <p>Overall Height: 18.41 (468) End 1 OD: 13.85 (352) End 1 ID: 7.44 (189) End 2 ID: 0.67 (17)</p>	<p>AF910 MACK 57MD21 For Upgrade, use AF910M Used With AF911 or AF967M depending on application</p>  <p>Gasket: 3312554 Overall Height: 9.00 (229) Overall OD: 12.77 (324) End 1 ID: 8.36 (212)</p>	<p>AF919 CASE 680587C2 Primary Air Filter used with AF929 3311624 Bolt Seal Included</p>  <p>Overall Height: 18.49 (470) Overall OD: 12.08 (307) End 1 ID: 7.73 (196) End 2 ID: 0.67 (17)</p>
<p>AF910M DONALDSON P142449, DONALDSON XLP182005 Upgrade of AF910</p>  <p>Gasket: 3312554 Overall Height: 9.00 (229) Overall OD: 12.77 (324) End 1 ID: 8.36 (212)</p>	<p>AF920 Safety Element used with AF408 3311624 Bolt Seal Included</p>  <p>Overall Height: 12.43 (316) Overall OD: 7.64 (194) End 1 ID: 6.05 (154) End 2 ID: 0.67 (17)</p>	<p>AF920 Safety Element used with AF408 3311624 Bolt Seal Included</p>  <p>Overall Height: 12.43 (316) Overall OD: 7.64 (194) End 1 ID: 6.05 (154) End 2 ID: 0.67 (17)</p>

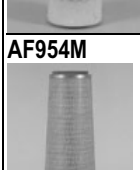
E. PRODUCT GUIDE

<p>AF921M</p>  <p>CATERPILLAR 4N0326 Primary Air Filter used with AF922 3311624 Bolt Seal Included</p> <p>Overall Height: 12.48 (317) End 1 OD: 6.85 (174) End 2 OD: 6.83 (174) End 1 ID: 0.67 (17) End 2 ID: 3.48 (88)</p>	<p>AF928M</p>  <p>DONALDSON XLP182056, CUMMINS 3022209 Primary Air Filter used with AF26380M Filter used with AH19325, AH19326 Extended Life Version of AF928</p> <p>Overall Height: 15.67 (398) End 1 OD: 12.09 (307) End 2 OD: 12.07 (307) End 1 ID: 7.74 (197) End 2 ID: 0.67 (17)</p>	<p>AF934</p>  <p>EUCLID 9039992 Safety Element used with AF935M 3830497 Bolt Seal Included</p> <p>Overall Height: 18.13 (460) End 1 OD: 11.92 (303) End 1 ID: 10.22 (259) End 2 ID: 0.90 (23)</p>
<p>AF922</p>  <p>CATERPILLAR 4N0313 Safety Element used with AF921M 3311624 Bolt Seal Included</p> <p>Overall Height: 10.37 (263) Overall OD: 3.37 (86) End 1 ID: 2.24 (57) End 2 ID: 0.67 (17)</p>	<p>AF929</p>  <p>IHC HOUSINGS 681911C91 Safety Element used with AF919 3311624 Bolt Seal Included</p> <p>Overall Height: 17.30 (439) End 1 OD: 0.68 (17) End 2 OD: 7.65 (194) End 1 ID: 6.02 (153)</p>	<p>AF935M</p>  <p>EUCLID 9039993 Primary Air Filter used with AF4862, AF934 . 3830497 Bolt Seal Included</p> <p>Gasket: 3308026 Overall Height: 19.60 (498) Boot Diameter: 18.58 (472) End 1 OD: 18.60 (472) End 2 OD: 17.60 (447) End 1 ID: 0.90 (23) End 2 ID: 12.23 (311)</p>
<p>AF923M</p>  <p>CASE 537337R1 Primary Air Filter used with AF924</p> <p>Overall Height: 15.53 (394) End 1 OD: 9.50 (241) End 2 OD: 8.48 (215) End 2 ID: 4.51 (115)</p>	<p>AF930M</p>  <p>FORD D2HZ9601C .250806 Bolt Seal Included</p> <p>Overall Height: 9.50 (241) End 1 OD: 12.00 (305) End 2 OD: 10.23 (260) End 1 ID: 0.54 (14) End 2 ID: 4.83 (123)</p>	<p>AF936</p>  <p>INGERSOLL-RAND 40070 Primary Air Filter used with AF264</p> <p>Overall Height: 16.06 (408) Overall OD: 16.64 (423) End 1 ID: 11.99 (305)</p>
<p>AF924</p>  <p>CASE 537338R2 Safety Element used with AF923M</p> <p>Overall Height: 14.38 (365) Overall OD: 4.47 (114) End 1 ID: 0.44 (11) End 2 ID: 3.41 (87)</p>	<p>AF931M</p>  <p>DONALDSON P129472</p> <p>Gasket: 3309314 Overall Height: 28.90 (734) End 1 OD: 8.66 (220) End 2 OD: 5.72 (145) End 1 ID: 5.21 (132)</p>	<p>AF937</p>  <p>STEIGER 71010 Safety Element used with AF4628M, AF939 . 3311624 Bolt Seal Included</p> <p>Overall Height: 16.41 (417) End 1 OD: 0.65 (17) End 2 OD: 5.97 (152) End 1 ID: 4.83 (123)</p>
<p>AF925</p>  <p>CASE 925761C1 Primary Air Filter used with AF926 250806 Bolt Seal Included</p> <p>Overall Height: 21.03 (534) Overall OD: 10.02 (255) End 1 ID: 5.48 (139) End 2 ID: 0.40 (10)</p>	<p>AF932</p>  <p>JOHN DEERE AT35155 Primary Air Filter used with AF487 3311624 Bolt Seal Included</p> <p>Overall Height: 12.50 (318) Overall OD: 7.93 (201) End 1 ID: 5.33 (135) End 2 ID: 0.67 (17)</p>	<p>AF938</p>  <p>STEIGER 45212 Safety Element used with AF427M 3311624 Bolt Seal Included</p> <p>Overall Height: 12.44 (316) End 1 OD: 4.89 (124) End 2 OD: 5.97 (152) End 1 ID: 4.83 (123) End 2 ID: 5.96 (151)</p>
<p>AF926</p>  <p>CASE 925762C1 Safety Element used with AF925 3311624 Bolt Seal Incl.</p> <p>Overall Height: 19.28 (490) End 1 ID: 4.02 (102) End 2 ID: 5.43 (138)</p>	<p>AF933</p>  <p>DONALDSON P181021 For Magnum Version use AF933M</p> <p>Overall Height: 10.50 (267) Overall OD: 10.40 (264) End 1 ID: 6.05 (154) End 2 ID: 0.33 (8) Thread Size: 5/16-18 UNC-2A</p>	<p>AF939</p>  <p>STEIGER 71011 Primary Air Filter used with AF937 3830497 Bolt Seal Included</p> <p>Overall Height: 18.49 (470) Overall OD: 10.40 (264) End 1 ID: 6.05 (154) End 2 ID: 0.90 (23)</p>
<p>AF927</p>  <p>VERSATILE 15803 Primary Air Filter used with AF918</p> <p>Overall Height: 20.38 (518) End 1 OD: 11.56 (294) End 2 OD: 9.63 (244) End 1 ID: 6.19 (157)</p>	<p>AF933M</p>  <p>DONALDSON XLP182021 Extended Life Version Of AF933</p> <p>Overall Height: 10.50 (267) Overall OD: 10.40 (264) End 1 ID: 6.05 (154) End 2 ID: 0.33 (8)</p>	<p>AF940K</p>  <p>MASSEY-FERGUSON 1428739M91 Primary Air Filter used with AF988 3311624 Bolt Seal Incl.</p> <p>Overall Height: 15.41 (391) Fin Diameter: 6.34 (161) End 2 OD: 5.24 (133) End 1 ID: 3.66 (93) End 2 ID: 0.67 (17)</p>

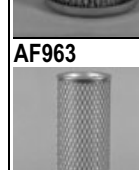
E. PRODUCT GUIDE

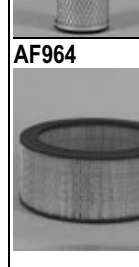
<p>AF941 CASE 466400C1</p>  <p>Overall Height: 8.64 (219) Overall OD: 12.59 (320) End 1 ID: 8.19 (208)</p>	<p>AF947 CUMMINS 4099423, JOHN DEERE AR61967, CAMECO INDUSTRIES AR79679 Primary Air Filter used with AF963 Filter used with 1403112, AH1148, AH19040, AH19322 250806 Bolt Seal Included</p>  <p>Overall Height: 17.11 (435) Overall OD: 9.10 (231) End 1 ID: 4.79 (122) End 2 ID: 0.38 (10)</p>	<p>AF956M FIAT-ALLIS 70671838 Primary Air Filter used with AF955 Extended Life Version of AF956. 3830497 Bolt Seal Included</p>  <p>Overall Height: 23.73 (603) End 1 OD: 12.80 (325) End 2 OD: 12.08 (307) End 1 ID: 0.90 (23) End 2 ID: 7.73 (196)</p>
<p>AF942 CASE 478974C1 For Magnum Version use AF942M</p>  <p>Overall Height: 12.34 (313) End 2 OD: 10.36 (263) End 1 ID: 6.02 (153)</p>	<p>AF948 KOMATSU 6001817210</p>  <p>Overall Height: 12.44 (316) Overall OD: 7.06 (179) End 1 ID: 3.94 (100) End 2 ID: 0.40 (10)</p>	<p>AF958M FORD D5HZ9601A</p>  <p>Overall Height: 16.55 (420) Cover Diameter: 14.12 (359) End 2 OD: 12.10 (307) End 2 ID: 6.69 (170)</p>
<p>AF942M Extended Life Version of AF942</p>  <p>Overall Height: 12.34 (313) End 1 OD: 10.36 (263) End 1 ID: 6.02 (153)</p>	<p>AF950 CHRYSLER 3614353</p>  <p>Overall Height: 3.51 (89) Overall OD: 10.88 (276) End 1 ID: 8.95 (227)</p>	<p>AF959 CATERPILLAR 9S9972 Safety Element used with AF335M Fleetguard Airkit Option AF4513 + AK00003</p>  <p>Overall Height: 13.11 (333) Cover Diameter: 9.04 (230) End 2 OD: 6.28 (160) End 1 ID: 4.61 (117)</p>
<p>AF943 STEIGER 45253 Safety Element used with AF851M . 3311624 Bolt Seal Included</p>  <p>Overall Height: 17.05 (433) End 1 OD: 8.65 (220) End 1 ID: 7.09 (180) End 2 ID: 0.65 (17)</p>	<p>AF951M FORD D5HZ9601B 3311624 Bolt Seal Included</p>  <p>Overall Height: 16.50 (419) Overall OD: 12.08 (307) End 1 ID: 7.73 (196) End 2 ID: 0.67 (17)</p>	<p>AF960 DONALDSON SMP181017 For Magnum Version use AF960M. 3308844S gasket is optional.</p>  <p>Overall Height: 29.01 (737) End 1 OD: 8.85 (225) End 2 OD: 8.83 (224) End 1 ID: 7.20 (183) End 2 ID: 5.82 (148)</p>
<p>AF944 CASE 433127C91, UNITED ENGINE LIFE 507D1</p>  <p>Overall Height: 8.49 (216) End 1 OD: 12.10 (307) End 2 OD: 12.08 (307) End 1 ID: 0.49 (12) End 2 ID: 7.73 (196)</p>	<p>AF953K CASE 3124008R91 3311624 Bolt Seal Included</p>  <p>Overall Height: 18.38 (467) Fin Diameter: 7.80 (198) End 2 OD: 6.10 (155) End 1 ID: 3.48 (88) End 2 ID: 0.67 (17)</p>	<p>AF960M DONALDSON XLP182017 Uses service part: 3308844S Extended Life Version of AF960. Gasket is optional.</p>  <p>Overall Height: 29.01 (737) End 1 OD: 8.85 (225) End 2 OD: 8.83 (224) End 1 ID: 7.20 (183) End 2 ID: 5.82 (148)</p>
<p>AF945K JOHN DEERE AT33363, JOHN DEERE AR39799 Primary Air Filter used with AF828</p>  <p>Overall Height: 10.38 (264) Fin Diameter: 8.69 (221) End 2 OD: 6.85 (174) End 1 ID: 4.23 (107) End 2 ID: 0.68 (17)</p>	<p>AF954M GMC 68999 Filter used with AH19099, AH19100</p>  <p>Gasket: 3311160 Overall Height: 28.90 (734) End 1 OD: 10.40 (264) End 2 OD: 7.49 (190) End 1 ID: 6.95 (177)</p>	<p>AF961 GALION D59585</p>  <p>Overall Height: 2.25 (57) Overall OD: 2.06 (52) End 1 ID: 0.88 (22) End 2 ID: 0.98 (25)</p>
<p>AF946M FORD D6HZ9601B 250806 Bolt Seal Included</p>  <p>Overall Height: 8.23 (209) End 1 OD: 12.00 (305) End 2 OD: 10.23 (260) End 1 ID: 0.54 (14) End 2 ID: 4.83 (123)</p>	<p>AF955 FIAT-ALLIS 70671839 Safety Element used with AF956, AF956M 3830497 Bolt Seal Included</p>  <p>Overall Height: 21.46 (545) End 1 OD: 0.90 (23) End 2 OD: 7.65 (194) End 1 ID: 6.02 (153) End 2 ID: 7.64 (194)</p>	<p>AF963 JOHN DEERE AR61968 Safety Element used with AF947, AF4668 Filter used with AH1147, AH1148</p>  <p>Overall Height: 14.20 (361) Overall OD: 4.67 (119) End 1 ID: 0.66 (17) End 2 ID: 4.03 (102)</p>
<p>AF956 Primary Air Filter used with AF955 For Magnum Version use AF956M. 3830497 Bolt Seal Included</p>  <p>Overall Height: 23.72 (602) Boot Diameter: 12.80 (325) End 1 ID: 0.90 (23) End 2 ID: 7.73 (196)</p>	<p>AF964 FORD D5HZ9601A</p>  <p>Overall Height: 5.51 (140) Overall OD: 12.62 (321) End 1 ID: 9.75 (248)</p>	<p>AF964 FORD D5HZ9601A</p>  <p>Overall Height: 5.51 (140) Overall OD: 12.62 (321) End 1 ID: 9.75 (248)</p>

E. PRODUCT GUIDE

AF965 FORD D4HZ9601B



Overall Height: 5.50 (140)
Overall OD: 12.60 (320)
End 1 ID: 8.35 (212)

AF966 MACK 57MD24 Uses service part: 3312553S, 3316953S For Magnum Version use AF966M.



Overall Height: 23.01 (584)
End 1 OD: 8.85 (225)
End 2 OD: 8.83 (224)
End 1 ID: 7.20 (183)
End 2 ID: 5.82 (148)

AF966M MACK 57MD24 Uses service part: 3312553S, 3316953S Extended Life Version of AF966.



Overall Height: 23.00 (584)
End 1 OD: 8.85 (225)
End 2 OD: 8.83 (224)
End 1 ID: 7.20 (183)
End 2 ID: 5.82 (148)

AF967M MACK 57MD29301



Overall Height: 15.03 (382)
Overall OD: 12.77 (324)
End 1 ID: 8.36 (212)

AF968 VOLVO 475386 250806 Bolt Seal Included



Overall Height: 14.54 (369)
Overall OD: 12.21 (310)
End 1 ID: 7.88 (200)
End 2 ID: 0.54 (14)

AF969 VOLVO 347138



Overall Height: 11.40 (290)
Cover Diameter: 9.25 (235)
End 2 OD: 8.39 (213)
End 1 ID: 0.35 (9)
End 2 ID: 4.13 (105)

AF970 MASSEY-FERGUSON 197946201



Overall Height: 19.50 (495)
Cover Diameter: 12.17 (309)
End 2 OD: 9.54 (242)
End 1 ID: 5.21 (132)
End 2 ID: 0.41 (11)

AF971 JOHN DEERE AZ23642 Primary Air Filter used with AF1841



Overall Height: 15.00 (381)
Cover Diameter: 10.95 (278)
End 2 OD: 8.96 (228)
End 1 ID: 0.41 (11)
End 2 ID: 4.61 (117)

AF972KM DONALDSON P132348 Primary Air Filter used with AF974 3311624 Bolt Seal Included



Overall Height: 16.57 (421)
Fin Diameter: 15.70 (399)
End 2 OD: 12.08 (307)
End 1 ID: 0.67 (17)
End 2 ID: 7.73 (196)

AF973 FARR T528



Height: 5.00 (127)
Length: 28.50 (724)
Width: 19.00 (483)

AF974 DONALDSON P132349 Safety Element used with AF972KM 3311624 Bolt Seal Included



Overall Height: 15.79 (401)
End 1 OD: 8.50 (216)
End 2 OD: 7.27 (185)
End 1 ID: 6.23 (158)
End 2 ID: 0.67 (17)

AF975M DONALDSON P124045, DONALDSON XLP182082 Primary Air Filter used with AF976 Is a longer version of AF25763M



Overall Height: 20.50 (521)
Overall OD: 10.86 (276)
End 1 ID: 6.50 (165)
End 2 ID: 0.92 (23)

AF976 DONALDSON P124047 Safety Element used with AF975M Is a longer version of AF25764 3311624 Bolt Seal Included



Overall Height: 19.50 (495)
End 1 OD: 0.67 (17)
End 2 OD: 6.41 (163)
End 1 ID: 5.27 (134)
End 2 ID: 6.39 (162)

AF977 MERCEDES-BENZ 10948304



Overall Height: 10.19 (259)
Cover Diameter: 15.16 (385)
End 2 OD: 12.85 (327)
End 1 ID: 0.41 (11)
End 2 ID: 6.58 (167)

AF978 MERCEDES-BENZ 10949304



Overall Height: 10.13 (257)
Cover Diameter: 13.27 (337)
End 2 OD: 10.87 (276)
End 1 ID: 0.41 (11)
End 2 ID: 5.26 (134)

AF979 DONALDSON SMP181028 Primary Air Filter used with AF987 For Upgrade, use AF979M



Overall Height: 16.51 (419)
Overall OD: 10.40 (264)
End 1 ID: 6.05 (154)

AF979M DONALDSON XLP182028 Primary Air Filter used with AF987 Upgrade of AF979 Extended Life Version Of AF979



Overall Height: 16.50 (419)
Overall OD: 10.40 (264)
End 1 ID: 6.05 (154)

AF980 TOWMOTOR 343008 Primary Air Filter used with AF1687



Overall Height: 10.85 (276)
Overall OD: 3.54 (90)
End 1 ID: 2.26 (58)

AF981 MERCEDES-BENZ 10949404



Overall Height: 8.63 (219)
Cover Diameter: 9.94 (252)
End 2 OD: 8.24 (209)
End 1 ID: 0.34 (9)
End 2 ID: 4.08 (104)

AF982 GMC 25040873, AC A784C, MOTORCRAFT FA709 Primary Air Filter used with AF986 For Upgrade, use AF982M



Overall Height: 18.55 (471)
End 2 OD: 12.04 (306)
End 1 ID: 7.77 (197)

AF982M CASE 476743C1 Primary Air Filter used with AF986 Upgrade of AF982 Extended Life Version of AF982

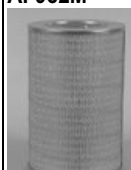

Overall Height: 18.55 (471)
End 2 OD: 12.04 (306)
End 1 ID: 7.77 (197)

AF983 HEIL 75A506 Hydraulic Air



Overall Height: 5.37 (136)
Largest OD: 3.69 (94)
Thread Size: 1-14 UNS-2B

AF984 CASE 530560C1 Safety Element used with AF994 3311624 Bolt Seal Included





















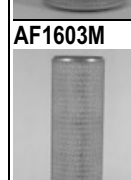



Overall Height: 14.44 (367)
End 1 OD: 0.67 (17)
End 2 OD: 7.21 (183)
End 1 ID: 5.66 (144)

AF986 Safety Element used with AF982, AF982M 3311624 Bolt Seal Included















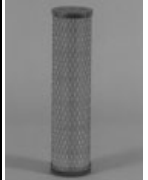





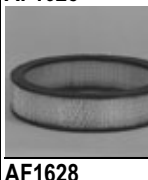
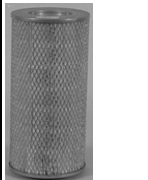

Overall Height: 15.79 (401)
End 1 OD: 0.68 (17)
End 2 OD: 7.65 (194)
End 1 ID: 6.02 (153)
End 2 ID: 7.64 (194)

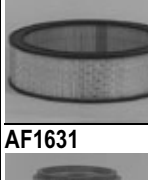





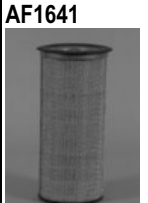



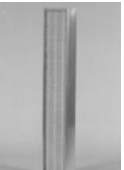
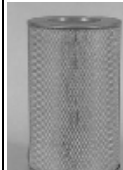
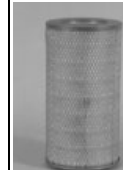

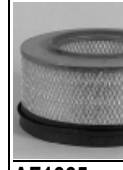

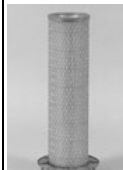
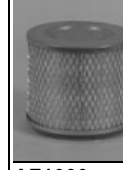

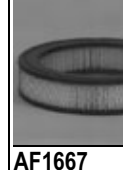
E. PRODUCT GUIDE

<p>AF987 CASE 482644C1 Safety Element used with AF979, AF979M</p>  <p>Overall Height: 13.78 (350) End 1 OD: 4.89 (124) End 2 OD: 5.91 (150) End 1 ID: 4.81 (122) End 2 ID: 5.98 (152)</p>	<p>AF995M GMC 717702 Uses service part: 3312555S</p>  <p>Gasket: 3312555 Overall Height: 19.88 (505) End 1 OD: 13.85 (352) End 2 OD: 13.83 (351) End 1 ID: 7.44 (189)</p>	<p>AF1601M MANN & HUMMEL C20325, KHD(KLOCKNER-HUMBOLDT-DEUTZ) 2241034 Primary Air Filter used with AF1840</p>  <p>Overall Height: 14.75 (375) Cover Diameter: 9.80 (249) End 2 OD: 7.78 (198) End 1 ID: 0.34 (9) End 2 ID: 4.08 (104)</p>
<p>AF988 MASSEY-FERGUSON 1037735M91 Safety Element used with AF1910M, AF940K</p>  <p>Overall Height: 14.04 (356) Overall OD: 3.75 (95) End 1 ID: 2.93 (74) End 2 ID: 0.66 (17)</p>	<p>AF996M VORTEX VF160R 3311624 Bolt Seal Included</p>  <p>Overall Height: 27.00 (686) End 1 OD: 12.79 (325) End 2 OD: 12.77 (324) End 1 ID: 0.67 (17) End 2 ID: 8.36 (212)</p>	<p>AF1602M MANN & HUMMEL C23726, SCANIA 269733</p>  <p>Overall Height: 14.93 (379) Cover Diameter: 10.98 (279) End 2 OD: 8.96 (228) End 1 ID: 0.41 (11) End 2 ID: 4.60 (117)</p>
<p>AF989 ATLAS COPCO 10300979 250806 Bolt Seal Included</p>  <p>Gasket: 3309167 (1) Overall Height: 14.24 (362) Overall OD: 13.83 (351) End 1 ID: 9.48 (241) End 2 ID: 0.54 (14)</p>	<p>AF997M MACK 57MD29305P2 Uses service part: 3312555S</p>  <p>Gasket: 3312555 Overall Height: 15.00 (381) Overall OD: 10.40 (264) End 1 ID: 6.05 (154)</p>	<p>AF1603M GMC 2034764</p>  <p>Overall Height: 28.43 (722) Overall OD: 9.01 (229) End 1 ID: 5.71 (145)</p>
<p>AF990 FENDT F278201090020 Primary Air Filter used with AF25424</p>  <p>Overall Height: 9.40 (239) Overall OD: 6.44 (164) End 1 ID: 3.38 (86)</p>	<p>AF998M MACK 57MD29305P1 Uses service part: 3312555S</p>  <p>Gasket: 3312555 Overall Height: 12.04 (306) Overall OD: 10.40 (264) End 1 ID: 6.95 (177)</p>	<p>AF1604 CUMMINS 3013213, KOMATSU VE1061, CAMECO INDUSTRIES 61380377 Safety Element used with AF1605M, AF4605M 3830497 Bolt Seal Included</p>  <p>Overall Height: 22.50 (572) End 2 OD: 10.25 (260) End 1 ID: 9.12 (232) End 2 ID: 0.88 (22)</p>
<p>AF991 KHD(KLOCKNER-HUMBOLDT-DEUTZ) 2339823 Primary Air Filter used with AF25425, AF4745</p>  <p>Overall Height: 13.08 (332) Overall OD: 6.44 (164) End 1 ID: 3.39 (86)</p>	<p>AF999 AP LOCKHEED AP497A, GMC 25096001, AC A181C, DONALDSON P539487</p>  <p>Overall Height: 8.09 (205) Overall OD: 10.40 (264) End 1 ID: 6.05 (154)</p>	<p>AF1605M CUMMINS 3013212, KOMATSU VE1062, CAMECO INDUSTRIES 61380371 Primary Air Filter used with AF1604</p>  <p>Overall Height: 24.50 (622) End 1 OD: 14.70 (373) End 2 OD: 14.69 (373) End 1 ID: 0.88 (22) End 2 ID: 10.30 (262)</p>
<p>AF992 FENDT F181200091040</p>  <p>Overall Height: 13.91 (353) Overall OD: 6.46 (164) End 1 ID: 3.38 (86)</p>	<p>AF1600 DONALDSON SMP181011 Uses service part: 3312555S For Magnum Version use AF1600M</p>  <p>Gasket: 3312555 Overall Height: 27.00 (686) End 1 OD: 13.76 (349) End 2 OD: 13.74 (349) End 1 ID: 7.40 (188)</p>	<p>AF1606K DONALDSON SMP181062</p>  <p>Overall Height: 15.42 (392) Fin Diameter: 6.40 (163) End 2 OD: 5.24 (133) End 1 ID: 3.25 (83) End 2 ID: 0.67 (17)</p>
<p>AF993 DONALDSON P130115 3830497 Bolt Seal Included</p>  <p>Overall Height: 13.51 (343) End 1 OD: 9.23 (234) End 2 OD: 9.21 (234) End 1 ID: 0.90 (23) End 2 ID: 4.86 (123)</p>	<p>AF1600M DONALDSON P123785, DONALDSON XLP182011 Uses service part: 3312555S Extended Life Version of AF1600</p>  <p>Gasket: 3312555 Overall Height: 27.00 (686) End 1 OD: 13.85 (352) End 2 OD: 13.83 (351) End 1 ID: 7.44 (189)</p>	<p>AF1606KM INGERSOLL-RAND 35291970, DONALDSON XLP182062 Primary Air Filter used with AF1892 Filter used with AH19063, AH19064 3311624 Bolt Seal Included</p>  <p>Overall Height: 15.42 (392) Fin Diameter: 6.34 (161) End 1 OD: 6.40 (163) End 2 OD: 5.24 (133) End 1 ID: 3.17 (81) End 2 ID: 0.67 (17)</p>
<p>AF994 CASE 530561C1 Primary Air Filter used with AF984 3311624 Bolt Seal Included</p>  <p>Overall Height: 15.76 (400) Overall OD: 12.08 (307) End 1 ID: 7.73 (196) End 2 ID: 0.67 (17)</p>		

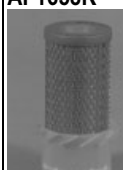
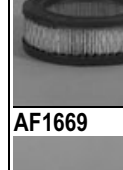



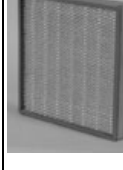





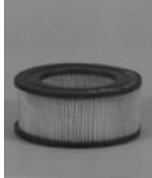

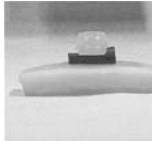



E. PRODUCT GUIDE

<p>AF1609 CATERPILLAR 6P6664 3834340 Wing Nut Included</p>  <p>Overall Height: 12.47 (317) End 1 OD: 6.85 (174) End 2 OD: 6.83 (174) End 2 ID: 4.23 (107)</p>	<p>AF1620 MANN & HUMMEL C241653, KHD(KLOCKNER- HUMBOLDT-DEUTZ) 2102752</p>  <p>Overall Height: 6.47 (164) Overall OD: 9.05 (230) End 1 ID: 6.36 (161)</p>	<p>AF1633 CASE A44804 Primary Air Filter used with AF1632</p>  <p>Overall Height: 9.54 (242) End 1 OD: 13.85 (352) End 2 OD: 13.83 (351) End 1 ID: 7.44 (189) End 2 ID: 0.67 (17)</p>
<p>AF1611M DONALDSON P137982 Available in Australia ONLY3830497 Bolt Seal Included</p>  <p>Overall Height: 16.56 (421) End 1 OD: 11.08 (281) End 1 ID: 6.73 (171) End 2 ID: 0.90 (23)</p>	<p>AF1622 JOHN DEERE AR80652 Primary Air Filter used with AF1623</p>  <p>Overall Height: 19.76 (502) Overall OD: 9.09 (231) End 1 ID: 6.22 (158) End 2 ID: 0.39 (10)</p>	<p>AF1635 MASSEY-FERGUSON 1039045M91 Safety Element used with AF4855, AF1704</p>  <p>Overall Height: 13.44 (341) Overall OD: 3.35 (85) End 1 ID: 0.28 (7) End 2 ID: 2.29 (58)</p>
<p>AF1612M DONALDSON P137981 Primary Air Filter used with AF1749 3830497 Bolt Seal Included</p>  <p>Overall Height: 18.48 (469) Overall OD: 12.08 (307) End 1 ID: 7.73 (196) End 2 ID: 0.90 (23)</p>	<p>AF1623 JOHN DEERE AR80653 Safety Element used with AF1622</p>  <p>Overall Height: 16.15 (410) Overall OD: 5.18 (132) End 1 ID: 4.13 (105) End 2 ID: 0.66 (17)</p>	<p>AF1636 JOHN DEERE AR82915 Primary Air Filter used with AF1637</p>  <p>Overall Height: 19.81 (503) Overall OD: 9.06 (230) End 1 ID: 0.45 (11) End 2 ID: 5.37 (136)</p>
<p>AF1613M GMC 2034763</p>  <p>Overall Height: 22.60 (574) Overall OD: 9.01 (229) End 1 ID: 5.71 (145)</p>	<p>AF1624 GMC 8994941</p>  <p>Overall Height: 5.30 (135) Overall OD: 5.09 (129) End 1 ID: 3.59 (91)</p>	<p>AF1637 JOHN DEERE AR81313 Safety Element used with AF1636</p>  <p>Overall Height: 16.19 (411) Overall OD: 4.70 (119) End 1 ID: 0.63 (16) End 2 ID: 4.04 (103)</p>
<p>AF1614 LEYLAND ACU2889</p>  <p>Overall Height: 11.52 (293) Overall OD: 9.21 (234) End 1 ID: 4.86 (123) End 2 ID: 0.67 (17)</p>	<p>AF1625 GMC 8996587</p>  <p>Overall Height: 2.29 (58) Overall OD: 10.09 (256) End 1 ID: 8.62 (219)</p>	<p>AF1638 JOHN DEERE AR54336 Primary Air Filter used with AF1639 Filter used with AH1146</p>  <p>Overall Height: 15.32 (389) End 1 OD: 7.35 (187) End 2 OD: 7.29 (185) End 1 ID: 0.39 (10) End 2 ID: 4.03 (102)</p>
<p>AF1616 WHITE 220055002 Filter used with AH19104, AH19106 For Magnum Version use AF1616M</p>  <p>Gasket: 3312556 Overall Height: 27.00 (686) Overall OD: 10.40 (264) End 1 ID: 6.05 (154)</p>	<p>AF1628 GMC 8997189 Same As AF1985 Without Foam Pre- Cleaner</p>  <p>Overall Height: 4.00 (102) Overall OD: 13.88 (353) End 1 ID: 11.62 (295)</p>	<p>AF1639 JOHN DEERE AR79942 Safety Element used with AF1638 Filter used with AH1146</p>  <p>Overall Height: 13.25 (337) End 1 OD: 3.88 (98) End 2 OD: 3.81 (97) End 1 ID: 0.63 (16) End 2 ID: 3.19 (81)</p>
<p>AF1616M WHITE 220055002 Extended Life Version Of AF1616</p>  <p>Gasket: 3312556 Overall Height: 27.00 (686) Overall OD: 10.40 (264) End 1 ID: 6.05 (154)</p>	<p>AF1631 MASSEY-FERGUSON 1041845M91 Primary Air Filter used with AF1685</p>  <p>Overall Height: 14.03 (356) End 1 OD: 8.69 (221) End 2 OD: 7.94 (202) End 1 ID: 5.30 (135) End 2 ID: 0.66 (17)</p>	<p>AF1640 FORD D1NN9R500A Safety Element used with AF1641</p>  <p>Overall Height: 13.56 (344) Overall OD: 3.63 (92) End 1 ID: 3.02 (77) End 2 ID: 0.44 (11)</p>
<p>AF1618 FORD D7EF9601AA</p>  <p>Overall Height: 1.75 (44) Overall OD: 11.25 (286) End 1 ID: 9.38 (238)</p>	<p>AF1632 CASE A44805 Safety Element used with AF1633</p>  <p>Overall Height: 8.38 (213) Overall OD: 6.84 (174) End 1 ID: 4.22 (107) End 2 ID: 0.66 (17)</p>	<p>AF1641 FORD D1NN9601A Primary Air Filter used with AF1640</p>  <p>Overall Height: 15.36 (390) Overall OD: 6.69 (170) End 1 ID: 0.54 (14) End 2 ID: 3.76 (96)</p>



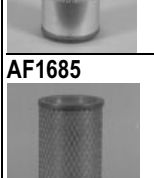
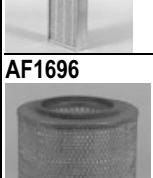
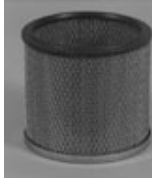
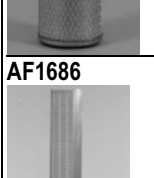
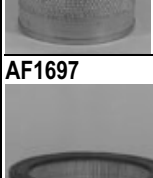

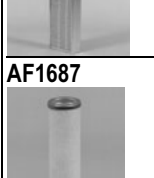
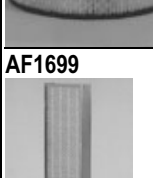
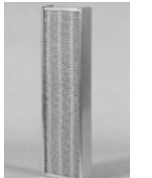

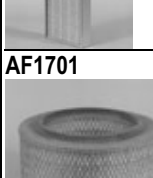





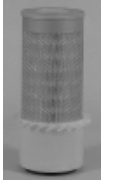



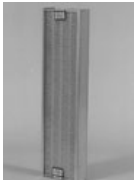
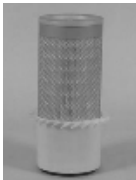

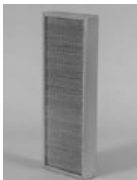

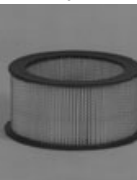

E. PRODUCT GUIDE

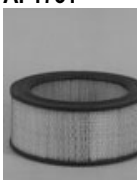
AF1642  CASE 175568C1 Height: 2.19 (56) Length: 32.00 (813) Width: 6.75 (171)	AF1652  JOY 12124040 Overall Height: 18.38 (467) Overall OD: 11.13 (283) End 1 ID: 6.44 (164) End 2 ID: 0.44 (11)	AF1663  JOHN DEERE AR49839 Overall Height: 17.20 (437) Overall OD: 9.06 (230) End 1 ID: 5.39 (137) End 2 ID: 0.38 (10)
AF1643  JOHN DEERE AR70106 Primary Air Filter used with AF1644 Overall Height: 20.38 (518) Overall OD: 10.40 (264) End 1 ID: 6.05 (154) End 2 ID: 0.90 (23)	AF1653  MASSEY-FERGUSON 1026137M91, MASSEY-FERGUSON 1029945M91 Overall Height: 9.25 (235) Overall OD: 4.09 (104) End 1 ID: 2.47 (63) End 2 ID: 0.38 (10)	AF1664  JOHN DEERE AR51431 Primary Air Filter used with AF1665 Overall Height: 7.25 (184) Overall OD: 13.84 (352) End 1 ID: 7.44 (189) End 2 ID: 0.63 (16)
AF1644  JOHN DEERE AR70107 Safety Element used with AF1643 Overall Height: 18.33 (466) End 1 OD: 5.97 (152) End 2 OD: 5.96 (151) End 1 ID: 0.67 (17) End 2 ID: 4.85 (123)	AF1654  CASE 606861C91 Safety Element used with AF869M Overall Height: 17.84 (453) Flange Diameter: 7.00 (178) End 2 OD: 4.61 (117) End 1 ID: 3.44 (87)	AF1665  JOHN DEERE AR51432 Safety Element used with AF1664, AF1693 Overall Height: 6.19 (157) Overall OD: 6.84 (174) End 1 ID: 4.22 (107) End 2 ID: 0.66 (17)
AF1647M  CATERPILLAR 4L4719 Overall Height: 18.26 (464) End 1 OD: 13.89 (353) End 2 OD: 13.83 (351) End 2 ID: 9.48 (241)	AF1655  MASSEY-FERGUSON 1028094M92 Overall Height: 15.38 (391) Overall OD: 6.09 (155) End 1 ID: 3.47 (88) End 2 ID: 0.66 (17)	AF1666  NISSAN 1654618000 Overall Height: 1.94 (49) Overall OD: 9.06 (230) End 1 ID: 6.84 (174)
AF1648  JOHN DEERE AM31000 Overall Height: 4.76 (121) Overall OD: 4.38 (111) End 1 ID: 3.00 (76)	AF1657  WISCONSIN LO173B Overall Height: 4.19 (106) Overall OD: 3.56 (90) End 1 ID: 2.12 (54)	AF1667  CHRYSLER 2402677, MOPAR L141 Height: 3.62 (92) Length: 11.44 (291) Width: 6.56 (167)
AF1649  NISSAN 1654623000, GMC 94020442 Overall Height: 2.41 (61) Overall OD: 10.20 (259) End 1 ID: 8.01 (203)	AF1658K  FIAT-ALLIS 70247060 Filter used with AH19107 Overall Height: 7.36 (187) Fin Diameter: 4.17 (106) End 2 OD: 3.27 (83) End 1 ID: 1.79 (46) End 2 ID: 0.41 (11)	AF1668  BRIGGS & STRATTON 296186, BRIGGS & STRATTON 296188 Overall Height: 1.56 (40) Overall OD: 4.39 (112) End 1 ID: 3.00 (76)
AF1650  Uses service part: 3835841S, 3835842S Allis-Chalmers, Autocar, Brockway, Cummins, FWD, Diamond T, Dodge, Hough, Hyster, IH Primary Air Blanket AF1807 element AF1888. Overall Height: 11.71 (297) Overall OD: 9.61 (244) End 1 ID: 5.20 (132)	AF1659  JOHN DEERE AR43605, JOHN DEERE AR43941 Overall Height: 12.38 (314) Overall OD: 6.85 (174) End 1 ID: 3.45 (88) End 2 ID: 0.88 (22)	AF1669  FRAM CA140PL Overall Height: 2.13 (54) Overall OD: 8.05 (204) End 1 ID: 6.48 (164)
AF1651  JOHN DEERE AM30800 Overall Height: 2.34 (59) Overall OD: 4.39 (112) End 1 ID: 3.00 (76)	AF1660  CATERPILLAR 6L8485 Height: 2.57 (65) Length: 15.00 (381) Width: 15.00 (381)	AF1670  CYCLONE AP250 Overall Height: 4.44 (113) Overall OD: 7.13 (181) End 1 ID: 4.94 (125)





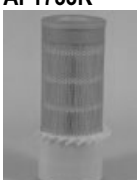











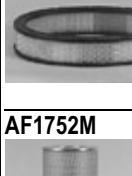

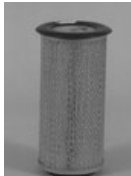

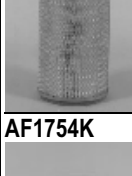
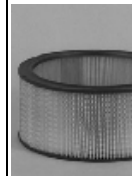

E. PRODUCT GUIDE

AF1671  AUSTIN-HEALY 1H1334 Overall Height: 2.52 (64) Overall OD: 5.94 (151) End 1 ID: 3.56 (90)	AF1680  MITSUBISHI 3083081900, DONALDSON P112212 Safety Element used with AF4059K 3311624 Bolt Seal Included Overall Height: 13.42 (341) Overall OD: 3.37 (86) End 1 ID: 2.24 (57) End 2 ID: 0.67 (17)	AF1690  CASE 67975C1 Safety Element used with AF1847 Overall Height: 15.50 (394) Overall OD: 5.56 (141) End 1 ID: 4.42 (112)
AF1672  GMC 6484966 Height: 1.50 (38) Overall OD: 0.82 (21) Length: 3.90 (99) Width: 1.70 (43)	AF1681  JOHN DEERE AH80920 Height: 2.19 (56) Length: 39.96 (1015) Width: 6.12 (155)	AF1693  CASE A44185 Primary Air Filter used with AF1665 Overall Height: 7.43 (189) End 1 OD: 13.85 (352) End 2 OD: 13.83 (351) End 1 ID: 7.44 (189) End 2 ID: 0.67 (17)
AF1673  FORD D1AZ9D65A For replacement foam see AF1964 Height: 1.30 (33) Overall OD: 0.55 (14) Length: 3.92 (99) Width: 1.68 (43)	AF1682  MASSEY-FERGUSON 1038946M91 Overall Height: 14.28 (363) Overall OD: 6.86 (174) End 1 ID: 4.20 (107)	AF1694  CASE 537334R1 Primary Air Filter used with AF1839 Overall Height: 13.47 (342) Overall OD: 6.08 (154) End 1 ID: 3.48 (88)
AF1674  FORD D3Z29601A Overall Height: 1.94 (49) Overall OD: 11.22 (285) End 1 ID: 9.03 (229)	AF1683  CASE 529851R2 Overall Height: 15.29 (388) Overall OD: 6.08 (154) End 1 ID: 3.48 (88)	AF1695  CASE F84818 Height: 2.19 (56) Length: 28.00 (711) Width: 7.50 (191)
AF1675  CASE A43734 Primary Air Filter used with AF1676 Overall Height: 7.50 (191) Overall OD: 11.72 (298) End 1 ID: 0.44 (11) End 2 ID: 7.16 (182)	AF1685  MASSEY-FERGUSON 1041846M91 Safety Element used with AF1631 Overall Height: 12.25 (311) Overall OD: 5.22 (133) End 1 ID: 4.08 (104) End 2 ID: 0.66 (17)	AF1696  FORD D2H29601A Overall Height: 10.38 (264) Overall OD: 9.19 (233) End 1 ID: 4.84 (123) End 2 ID: 0.53 (13)
AF1676  CASE A43735 Safety Element used with AF1675 Overall Height: 6.13 (156) Overall OD: 6.81 (173) End 1 ID: 0.44 (11) End 2 ID: 5.53 (140)	AF1686  DONALDSON P117109 For Element w/ Clip Use AF1686C Height: 2.19 (56) Length: 33.00 (838) Width: 6.50 (165)	AF1697  MOPAR L539 Overall Height: 2.41 (61) Overall OD: 9.75 (248) End 1 ID: 7.56 (192)
AF1677  JOHN DEERE AR61903 Height: 2.69 (68) Length: 28.00 (711) Width: 7.50 (191)	AF1687  FORD D2NN9R500A, MASSEY-FERGUSON 1094269M91 Safety Element used with AF980, AF1954, AF492 Overall Height: 10.31 (262) End 1 OD: 2.50 (64) End 2 OD: 2.12 (54) End 1 ID: 1.86 (47) End 2 ID: 0.38 (10)	AF1699  MASSEY-FERGUSON 525446M1 Height: 2.19 (56) Length: 28.94 (735) Width: 9.25 (235)
AF1678  CASE T39515 Height: 2.23 (57) Length: 23.50 (597) Width: 7.00 (178)	AF1688  FORD D2NN9601A Overall Height: 14.38 (365) End 1 OD: 9.81 (249) End 2 OD: 7.94 (202) End 1 ID: 0.53 (13) End 2 ID: 4.63 (117)	AF1701  CASE A44694 Primary Air Filter used with AF1702 Overall Height: 7.55 (192) Boot Diameter: 13.13 (334) End 2 OD: 12.08 (307) End 1 ID: 7.73 (196) End 2 ID: 0.67 (17)





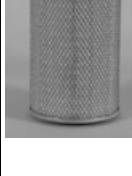









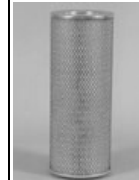

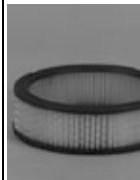



E. PRODUCT GUIDE

<p>AF1702 CASE A44695 Safety Element used with AF1701</p>  <p>Overall Height: 5.26 (134) Overall OD: 6.84 (174) End 1 ID: 4.22 (107)</p>	<p>AF1724 FORD C9NN9R500B, FORD D2NN9R500B</p>  <p>Overall Height: 13.75 (349) Overall OD: 4.56 (116) End 1 ID: 3.47 (88) End 2 ID: 0.53 (13)</p>	<p>AF1733KM DONALDSON XLP182059 Primary Air Filter used with AF4103 Extended Life Version Of AF1733K</p>  <p>Overall Height: 15.54 (395) Fin Diameter: 7.85 (200) End 2 OD: 6.08 (154) End 1 ID: 3.48 (88) End 2 ID: 0.67 (17)</p>
<p>AF1704 MASSEY-FERGUSON 1039044M91 Primary Air Filter used with AF1635</p>  <p>Overall Height: 14.38 (365) Overall OD: 5.31 (135) End 1 ID: 3.44 (87)</p>	<p>AF1726 CATERPILLAR 6P1290</p>  <p>Height: 2.19 (56) Length: 25.50 (648) Width: 6.00 (152)</p>	<p>AF1734 AIR MAZE 125954016</p>  <p>Height: 2.23 (57) Length: 26.00 (660) Width: 7.00 (178)</p>
<p>AF1707 AC A705C, GMC 8995405</p>  <p>Overall Height: 2.61 (66) Overall OD: 9.06 (230) End 1 ID: 6.84 (174)</p>	<p>AF1727 DONALDSON P122115, NEW HOLLAND 73107280</p>  <p>Height: 2.19 (56) Length: 23.50 (597) Width: 6.50 (165)</p>	<p>AF1735K FIAT-ALLIS 70266787 Primary Air Filter used with AF4150 Filter used with AH19269</p>  <p>Overall Height: 16.58 (421) Fin Diameter: 8.88 (226) End 2 OD: 6.85 (174) End 1 ID: 4.23 (108) End 2 ID: 0.67 (17)</p>
<p>AF1708 CASE C15861, IHC 488619R91</p>  <p>Overall Height: 2.06 (52) End 1 OD: 3.81 (97) End 2 OD: 3.00 (76) End 1 ID: 2.41 (61)</p>	<p>AF1728 DONALDSON P113407</p>  <p>Height: 2.19 (56) Length: 20.00 (508) Width: 7.50 (191)</p>	<p>AF1736 FORD 77HB9601AA</p>  <p>Overall Height: 20.50 (521) Flange Diameter: 15.19 (386) End 2 OD: 12.08 (307) End 1 ID: 0.18 (5) End 2 ID: 7.73 (196)</p>
<p>AF1710 GMC 5645381</p>  <p>Overall Height: 3.25 (83) End 1 OD: 7.31 (186) End 2 OD: 6.50 (165) End 1 ID: 4.25 (108)</p>	<p>AF1730 CATERPILLAR 6K9606</p>  <p>Height: 0.95 (24) Length: 23.43 (595) Width: 7.00 (178)</p>	<p>AF1737M GMC 2014573</p>  <p>Gasket: 3312553 Overall Height: 14.97 (380) End 1 OD: 8.85 (225) End 2 OD: 8.83 (224) End 1 ID: 7.20 (183) End 2 ID: 5.82 (148)</p>
<p>AF1712 MASSEY-FERGUSON 1038944M91</p>  <p>Overall Height: 16.43 (417) Overall OD: 7.64 (194) End 1 ID: 4.29 (109)</p>	<p>AF1731 CASE 446661C2 For element with foam wrap use AF1983</p>  <p>Overall Height: 5.00 (127) Overall OD: 11.56 (294) End 1 ID: 8.28 (210)</p>	<p>AF1738 CASE 631422C1 Safety Element used with AF1740 3311624 Bolt Seal Included</p>  <p>Overall Height: 12.11 (308) Overall OD: 3.88 (99) End 1 ID: 2.48 (63) End 2 ID: 0.67 (17)</p>
<p>AF1720 HONDA 17220671000</p>  <p>Overall Height: 2.00 (51) Overall OD: 10.23 (260) End 1 ID: 7.64 (194)</p>	<p>AF1732K CASE A43264 Primary Air Filter used with AF488</p>  <p>Overall Height: 13.38 (340) Fin Diameter: 10.00 (254) End 2 OD: 7.94 (202) End 1 ID: 5.30 (135) End 2 ID: 0.66 (17)</p>	<p>AF1739 DONALDSON P113632 Safety Element used with AF1747K 3311624 Bolt Seal Included</p>  <p>Overall Height: 13.42 (341) Overall OD: 4.08 (104) End 1 ID: 2.56 (65) End 2 ID: 0.67 (17)</p>
<p>AF1722 CASE A42573 For filter with gasket use AF1870</p>  <p>Height: 2.50 (64) Length: 38.00 (965) Width: 6.00 (152)</p>	<p>AF1733K MASSEY-FERGUSON 1093682M91 Primary Air Filter used with AF4103 Filter used with AH19267, AH19268 For Magnum Version use AF1733KM</p>  <p>Overall Height: 15.35 (390) Fin Diameter: 7.85 (200) End 2 OD: 6.08 (154) End 1 ID: 3.48 (88) End 2 ID: 0.67 (17)</p>	<p>AF1740 CASE 631421C1 Primary Air Filter used with AF1738</p>  <p>Overall Height: 14.63 (371) Overall OD: 7.35 (187) End 1 ID: 4.00 (102) End 2 ID: 0.38 (10)</p>

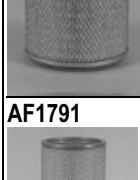
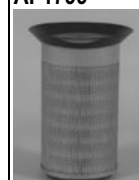

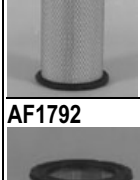

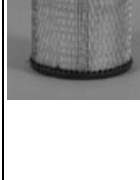





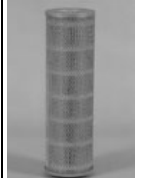











E. PRODUCT GUIDE

AF1741  WHITE 220050004 Height: 5.00 (127) Length: 28.50 (724) Width: 19.00 (483)	AF1749  DONALDSON P138789 Safety Element used with AF1612M 3311624 Bolt Seal Included Overall Height: 16.40 (417) End 1 OD: 6.25 (159) End 1 ID: 6.19 (157) End 2 ID: 0.65 (17)	AF1758M  GMC 2031381 Overall Height: 15.98 (406) End 1 OD: 8.66 (220) End 2 OD: 5.81 (147) End 1 ID: 5.21 (132)
AF1742M  CASE 574845C1 Overall Height: 23.00 (584) End 1 OD: 8.66 (220) End 2 OD: 5.81 (147) End 1 ID: 5.21 (132)	AF1750  GMC 8996555 Rectangular shaped Overall Height: 2.11 (54) End 1 OD: 10.70 (272) End 2 OD: 9.25 (235) End 1 ID: 9.14 (232) End 2 ID: 7.69 (195)	AF1759  QUINCY 125042001 Height: 5.38 (137) Length: 11.50 (292) Width: 15.00 (381)
AF1743M  CASE 574844C1 Gasket: 3311631 (1) Overall Height: 22.90 (582) End 1 OD: 10.40 (264) End 2 OD: 7.49 (190) End 1 ID: 6.95 (177)	AF1751  GMC 8996528 Oval shaped Overall Height: 1.91 (49) End 1 OD: 10.41 (264) End 2 OD: 8.38 (213) End 1 ID: 8.84 (225) End 2 ID: 6.81 (173)	AF1760M  CASE 3242256R1 3830497 Bolt Seal Included Overall Height: 15.31 (389) End 1 OD: 9.23 (234) End 2 OD: 9.21 (234) End 1 ID: 0.90 (23) End 2 ID: 4.86 (123)
AF1744M  FORD D6NN9601A Primary Air Filter used with AF1766 250806 Bolt Seal Included Overall Height: 11.54 (293) End 1 OD: 5.91 (150) End 2 OD: 5.24 (133) End 1 ID: 0.49 (13) End 2 ID: 3.17 (81)	AF1752M  VOLVO 475975 Overall Height: 24.08 (612) Overall OD: 7.87 (200) End 1 ID: 4.54 (115) End 2 ID: 0.41 (10)	AF1761  JOY 1224813 Overall Height: 5.25 (133) Overall OD: 9.88 (251) End 1 ID: 6.06 (154) End 2 ID: 6.02 (153)
AF1746  DONALDSON P114653 Height: 2.13 (54) Length: 30.56 (776) Width: 8.56 (217)	AF1753  DONALDSON P130747 3311624 Bolt Seal Included 3317119 Wing Nut Overall Height: 16.44 (418) Overall OD: 7.93 (201) End 1 ID: 3.58 (91) End 2 ID: 0.67 (17)	AF1762  GMC 8997890 Overall Height: 5.41 (137) Overall OD: 12.00 (305) End 1 ID: 9.82 (249)
AF1747K  DONALDSON P113636 Primary Air Filter used with AF1739 Overall Height: 14.38 (365) Fin Diameter: 8.69 (221) End 2 OD: 6.84 (174) End 1 ID: 4.22 (107) End 2 ID: 0.66 (17)	AF1754K  FORD D0HZ9601D Complete With Reusable Lid. For Element Only Use AF1755. Overall Height: 10.36 (263) Cover Diameter: 12.38 (314) Fin Diameter: 11.47 (291) End 2 OD: 9.04 (230) End 1 ID: 0.54 (14) End 2 ID: 4.93 (125)	AF1763K  DONALDSON P127172 Overall Height: 10.50 (267) Fin Diameter: 10.08 (256) End 2 OD: 7.93 (201) End 1 ID: 0.67 (17) End 2 ID: 3.58 (91)
AF1748  DONALDSON SMP181058 Uses service part: 3312555S For Upgrade, use AF1748M Gasket: 3312555 Overall Height: 24.00 (610) End 1 OD: 13.85 (352) End 2 OD: 13.83 (351) End 1 ID: 7.44 (189)	AF1755  MOTORCRAFT FA1008 250806 Bolt Seal Included Overall Height: 10.61 (269) Overall OD: 8.89 (226) End 1 ID: 4.98 (127)	AF1765M  WHITE 220050009 Overall Height: 16.10 (409) End 1 OD: 16.23 (412) End 2 OD: 13.85 (352) End 2 ID: 7.44 (189)
AF1748M  DONALDSON P132069 Uses service part: 3312555S Upgrade of AF1748 Gasket: 3312555 Overall Height: 24.00 (610) End 1 OD: 13.85 (352) End 2 OD: 13.83 (351) End 1 ID: 7.44 (189)	AF1756M  VOLVO 1517842 Overall Height: 12.67 (322) Overall OD: 8.39 (213) End 1 ID: 4.02 (102)	AF1766  FORD D6NN9R500A Safety Element used with AF1744M Overall Height: 10.08 (256) End 1 OD: 2.87 (73) End 2 OD: 2.84 (72) End 1 ID: 2.32 (59) End 2 ID: 0.43 (11)

















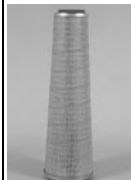

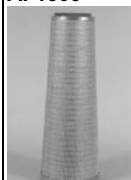
E. PRODUCT GUIDE

AF1767  YALE & TOWNE 408481 Safety Element used with AF1768M, AF4865M 3311624 Bolt Seal Included Overall Height: 12.50 (318) End 1 OD: 5.72 (145) End 1 ID: 4.56 (116) End 2 ID: 5.72 (145)	AF1781M  GMC 717714, GMC 25040535 Uses service part: 3312555S Gasket: 3312555 Overall Height: 26.00 (660) End 1 OD: 13.85 (352) End 2 OD: 13.83 (351) End 2 ID: 7.44 (189)	AF1793  MANN & HUMMEL C246502 Overall Height: 19.50 (495) Cover Diameter: 12.17 (309) End 2 OD: 9.54 (242) End 1 ID: 0.41 (11) End 2 ID: 5.21 (132)
AF1768M  YALE & TOWNE 408480 Primary Air Filter used with AF1767 3830497 Bolt Seal Included Overall Height: 13.44 (341) Overall OD: 9.14 (232) End 1 ID: 5.87 (149) End 2 ID: 0.90 (23)	AF1782  AIR MAZE CD1221B05826 Overall Height: 17.95 (456) Overall OD: 10.00 (254) End 1 ID: 6.69 (170) End 2 ID: 0.43 (11)	AF1795M  VOLVO 6872683 Overall Height: 20.38 (518) Overall OD: 7.87 (200) End 1 ID: 4.54 (115) End 2 ID: 0.41 (10)
AF1769  PERKINS PE322 Overall Height: 2.99 (76) Overall OD: 6.89 (175) End 1 ID: 5.04 (128)	AF1785  GMC 25040881 Overall Height: 2.47 (63) Overall OD: 8.43 (214) End 1 ID: 6.93 (176)	AF1796M  WHITE 220055001 Gasket: 3312554 Overall Height: 19.01 (483) End 1 OD: 12.79 (325) End 2 OD: 12.77 (324) End 2 ID: 8.36 (212)
AF1770  CHRYSLER 5240668 Overall Height: 5.78 (147) Overall OD: 4.39 (112) End 1 ID: 3.00 (76)	AF1788  GMC 25041208 Overall Height: 2.62 (67) Overall OD: 13.88 (353) End 1 ID: 11.62 (295)	AF1797M  FORD E2HZ9601A Gasket: 3309167 Overall Height: 29.03 (737) End 1 OD: 12.77 (324) End 2 OD: 9.81 (249) End 1 ID: 8.33 (212)
AF1771  FORD E1FZ9601A Overall Height: 2.01 (51) End 1 OD: 14.57 (370) End 2 OD: 7.87 (200) End 1 ID: 12.68 (322) End 2 ID: 5.98 (152)	AF1789  GMC 25041646 Overall Height: 1.75 (44) Overall OD: 9.31 (236) End 1 ID: 7.50 (191)	AF1798  M.A.N. 81083040024 Overall Height: 15.06 (383) End 1 OD: 8.98 (228) End 2 ID: 4.60 (117)
AF1773  CHRYSLER 4227087 Height: 1.65 (42) Length: 8.07 (205) Width: 5.26 (134)	AF1790M  MACK 57MD32 3311624 Bolt Seal Included Overall Height: 7.55 (192) Overall OD: 8.85 (225) End 1 ID: 5.45 (138) End 2 ID: 0.67 (17)	AF1799  RENAULT V.I. 5000243970 Overall Height: 12.78 (325) End 1 OD: 9.36 (238) End 2 OD: 7.11 (181) End 1 ID: 0.36 (9) End 2 ID: 4.16 (106)
AF1774  V.A.G. (VOLKSWAGEN, AUDI) 113129620 Height: 1.62 (41) Length: 13.23 (336) Width: 5.26 (134)	AF1791  KOMATSU 6127817413 Safety Element used with AF4504M 3311624 Bolt Seal Included Overall Height: 17.68 (449) End 1 OD: 8.43 (214) End 2 OD: 7.31 (186) End 1 ID: 6.23 (158) End 2 ID: 0.67 (17)	AF1800  RENAULT V.I. 5000559387 Overall Height: 13.45 (342) Cover Diameter: 7.96 (202) End 2 OD: 5.97 (152) End 1 ID: 0.36 (9) End 2 ID: 3.33 (85)
AF1777  FORD D7ZE9601A Overall Height: 2.19 (56) Overall OD: 11.03 (280) End 1 ID: 8.50 (216)	AF1792  LEROI H43651 Overall Height: 4.75 (121) Overall OD: 4.37 (111) End 1 ID: 3.00 (76)	AF1801  MERCEDES-BENZ 10949604 Overall Height: 13.83 (351) Cover Diameter: 7.76 (197) End 2 OD: 6.44 (164) End 1 ID: 0.34 (9) End 2 ID: 3.41 (87)
AF1780  GMC 25040929 Overall Height: 2.82 (72) Overall OD: 9.69 (246) End 1 ID: 8.12 (206)		







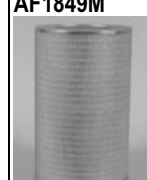



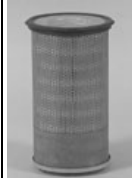

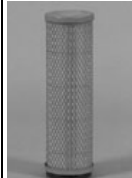

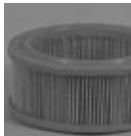



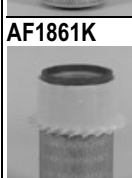

E. PRODUCT GUIDE

<p>AF1802 M.A.N. 81083040044 Primary Air Filter used with AF4523 Seal included.</p>  <p>Overall Height: 18.72 (476) End 1 OD: 11.88 (302) End 2 OD: 11.84 (301) End 1 ID: 7.55 (192) End 2 ID: 0.41 (11)</p>	<p>AF1810 CROSLAND 9608</p>  <p>Overall Height: 18.30 (465) Overall OD: 5.43 (138) End 1 ID: 2.86 (73) End 2 ID: 0.67 (17)</p>	<p>AF1817M DONALDSON P185027 Upgrade of AF1817</p>  <p>Gasket: 3309167 Overall Height: 25.01 (635) End 1 OD: 12.77 (324) End 2 OD: 9.81 (249) End 1 ID: 8.33 (212)</p>
<p>AF1803 VOLVO 1131838, MANN & HUMMEL C23690</p>  <p>Overall Height: 15.13 (384) Cover Diameter: 10.95 (278) End 2 OD: 8.96 (228) End 1 ID: 0.41 (11) End 2 ID: 4.61 (117)</p>	<p>AF1811 FORD 81DB9601TB</p>  <p>Overall Height: 15.37 (391) End 1 OD: 7.01 (178) End 2 OD: 6.06 (154) End 1 ID: 3.54 (90) End 2 ID: 0.67 (17)</p>	<p>AF1819 MASSEY-FERGUSON 1051376M91</p>  <p>Overall Height: 20.68 (525) Overall OD: 11.50 (292) End 1 ID: 7.00 (178) End 2 ID: 0.40 (10)</p>
<p>AF1804 M.A.N. 81083040039, MANN & HUMMEL C247001</p>  <p>Overall Height: 19.62 (498) End 1 OD: 9.56 (243) End 2 OD: 9.54 (242) End 2 ID: 5.21 (132)</p>	<p>AF1812 MERCEDES-BENZ 20942404</p>  <p>Overall Height: 13.91 (353) Cover Diameter: 15.16 (385) End 2 OD: 12.85 (327) End 1 ID: 0.41 (11) End 2 ID: 6.58 (167)</p>	<p>AF1820M CATERPILLAR 7N1225</p>  <p>Overall Height: 9.50 (241) Overall OD: 10.40 (264) End 1 ID: 6.05 (154)</p>
<p>AF1805M CATERPILLAR 1W2516</p>  <p>Overall Height: 19.03 (483) End 1 OD: 12.49 (317) End 2 ID: 9.11 (231)</p>	<p>AF1813 LEYLAND ACU3731</p>  <p>Overall Height: 18.47 (469) End 1 OD: 8.25 (210) End 2 OD: 7.24 (184) End 1 ID: 4.65 (118) End 2 ID: 0.67 (17)</p>	<p>AF1821M FRAM CA2570</p>  <p>Gasket: 3310237 Overall Height: 28.38 (721) End 1 OD: 9.54 (242) End 2 OD: 9.50 (241) End 1 ID: 0.39 (10) End 2 ID: 6.49 (165)</p>
<p>AF1806M WHITE 220050012</p>  <p>Overall Height: 16.05 (408) Overall OD: 12.10 (307) End 1 ID: 6.69 (170)</p>	<p>AF1814M WHITE 220050013</p>  <p>Overall Height: 15.55 (395) End 1 OD: 16.26 (413) End 2 OD: 13.85 (352) End 2 ID: 7.44 (189)</p>	<p>AF1822 NISSAN 16546L3000</p>  <p>Overall Height: 6.72 (171) Overall OD: 4.97 (126) End 1 ID: 2.76 (70) End 2 ID: 0.44 (11)</p>
<p>AF1807 FRAM CA240B Precleaner used with AF1888 Complete Assembly is AF1650</p>  <p>Height: 10.40 (264) Length: 29.00 (737) Width: 1.00 (25)</p>	<p>AF1815 DONALDSON P141284 For Magnum Version use AF1815M</p>  <p>Overall Height: 8.05 (204) Overall OD: 12.08 (307) End 1 ID: 8.69 (221)</p>	<p>AF1823K DONALDSON P120281 Primary Air Filter used with AF1824 Filter used with AH19061, AH19062</p>  <p>Overall Height: 14.39 (365) Fin Diameter: 5.16 (131) End 2 OD: 4.08 (104) End 1 ID: 2.56 (65) End 2 ID: 0.67 (17)</p>
<p>AF1808M FRAM CA2550</p>  <p>Overall Height: 28.38 (721) Overall OD: 9.50 (241) End 1 ID: 6.49 (165)</p>	<p>AF1815M Extended Life Version of AF1815</p>  <p>Overall Height: 8.05 (204) Overall OD: 12.08 (307) End 1 ID: 8.69 (221)</p>	<p>AF1824 DONALDSON P120307 Safety Element used with AF1823K Filter used with AH19062</p>  <p>Overall Height: 13.14 (334) End 1 OD: 4.50 (114) End 2 OD: 2.38 (60) End 1 ID: 2.00 (51) End 2 ID: 0.65 (16)</p>
<p>AF1809 MANN & HUMMEL C30880</p>  <p>Overall Height: 18.72 (476) Cover Diameter: 14.96 (380) End 2 OD: 11.88 (302) End 1 ID: 0.41 (11) End 2 ID: 7.55 (192)</p>	<p>AF1817 DONALDSON P142100 For Upgrade, use AF1817M</p>  <p>Gasket: 3309167 Overall Height: 25.01 (635) End 1 OD: 12.77 (324) End 2 OD: 9.81 (249) End 1 ID: 8.33 (212)</p>	<p>AF1825 COOPERS AZA188T</p>  <p>Overall Height: 18.52 (470) Cover Diameter: 9.37 (238) End 2 OD: 8.25 (210) End 1 ID: 4.65 (118)</p>







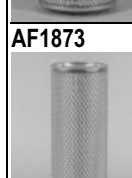



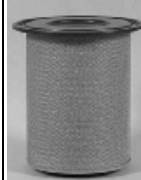
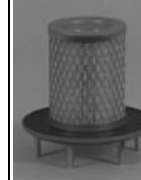

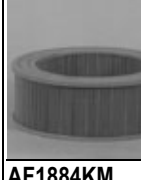
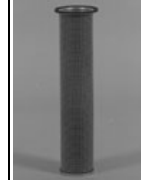







E. PRODUCT GUIDE

<p>AF1826K LEYLAND BAU1475, COOPERS AZA360T</p>  <p>Overall Height: 18.37 (467) Fin Diameter: 6.34 (161) End 2 OD: 5.24 (133) End 1 ID: 2.71 (69) End 2 ID: 0.67 (17)</p>	<p>AF1833 CATERPILLAR 6N6444 Safety Element used with AF873M Fleetguard Airkit Option AF4515 + AK00006</p>  <p>Overall Height: 11.97 (304) Flange Diameter: 11.42 (290) End 2 OD: 8.62 (219) End 1 ID: 7.00 (178) End 2 ID: 7.06 (179)</p>	<p>AF1842 BOMAG 5821015, KHD(KLOCKNER-HUMBOLDT-DEUTZ) 2985037, VOLVO 4765611 Safety Element used with AF4058</p>  <p>Overall Height: 13.56 (345) End 1 OD: 3.54 (90) End 2 OD: 3.31 (84) End 1 ID: 2.74 (70) End 2 ID: 0.67 (17)</p>
<p>AF1827 BENDIX 100783, MIDLAND STEEL 100696A</p>  <p>Overall Height: 1.03 (26) Overall OD: 2.73 (69) End 1 ID: 1.38 (35)</p>	<p>AF1835 FORD D6NN9R500B Safety Element used with AF1855</p>  <p>Overall Height: 13.43 (341) Overall OD: 2.87 (73) End 1 ID: 2.32 (59) End 2 ID: 0.43 (11)</p>	<p>AF1843 VOLVO 4785749 Safety Element used with AF4060</p>  <p>Overall Height: 18.84 (479) End 1 OD: 5.51 (140) End 2 OD: 5.12 (130) End 1 ID: 4.55 (116) End 2 ID: 0.67 (17)</p>
<p>AF1828 DONALDSON P124861 Primary Air Filter used with AF1894M Filter used with AH19259 Is a longer version of AF25762 3830497S Bolt Seal Included</p>  <p>Overall Height: 20.70 (526) Boot Diameter: 12.80 (325) End 1 OD: 12.80 (325) End 2 OD: 12.08 (307) End 1 ID: 0.90 (23) End 2 ID: 7.73 (196)</p>	<p>AF1837 DONALDSON P148044</p>  <p>Gasket: 3309314 Overall Height: 28.90 (734) End 1 OD: 8.66 (220) End 2 OD: 5.81 (147) End 1 ID: 5.21 (132)</p>	<p>AF1844 FRAM CA230B Precleaner used with AF1893, AF1894M, AF252 Precleaner Blanket</p>  <p>Height: 1.00 (25) Length: 25.38 (645) Width: 8.75 (222)</p>
<p>AF1829 MANN & HUMMEL C27585</p>  <p>Overall Height: 9.11 (232) Cover Diameter: 12.99 (330) End 2 OD: 10.39 (264) End 1 ID: 0.41 (11) End 2 ID: 5.20 (132)</p>	<p>AF1838 DONALDSON P148043</p>  <p>Gasket: 3311631 Overall Height: 28.90 (734) End 1 OD: 10.40 (264) End 2 OD: 7.49 (190) End 1 ID: 6.95 (177)</p>	<p>AF1845K J.C.B. 32203702 Primary Air Filter used with AF1851</p>  <p>Overall Height: 12.52 (318) Fin Diameter: 6.34 (161) End 2 OD: 5.24 (133) End 1 ID: 2.82 (72) End 2 ID: 0.67 (17)</p>
<p>AF1830KM CASE 924779C2 Primary Air Filter used with AF1839 3311624 Bolt Seal Included</p>  <p>Overall Height: 12.50 (318) Fin Diameter: 6.34 (161) End 2 OD: 5.24 (133) End 1 ID: 3.35 (85) End 2 ID: 0.67 (17)</p>	<p>AF1839 CASE 537335R1 Safety Element used with AF1694, AF1830KM</p>  <p>Overall Height: 11.08 (282) End 1 OD: 3.62 (92) End 2 OD: 2.95 (75) End 1 ID: 2.42 (62) End 2 ID: 0.67 (17)</p>	<p>AF1846 DONALDSON P150694</p>  <p>Overall Height: 28.40 (721) End 1 OD: 10.40 (264) End 2 OD: 7.49 (190) End 1 ID: 6.95 (177)</p>
<p>AF1831 DONALDSON P138037 3830497 Bolt Seal Included</p>  <p>Overall Height: 16.40 (417) End 1 OD: 0.92 (23) End 2 OD: 8.26 (210) End 1 ID: 7.10 (180) End 2 ID: 8.26 (210)</p>	<p>AF1840 BOMAG 5821014, LIEBHERR 7360733, VOLVO 6644988, FENDT F184230090100 Safety Element used with AF25044M, AF25064, AF1601M</p>  <p>Overall Height: 14.78 (376) End 1 OD: 4.33 (110) End 2 OD: 3.98 (101) End 1 ID: 3.41 (87) End 2 ID: 0.67 (17)</p>	<p>AF1847 CASE 67974C4 Primary Air Filter used with AF1690</p>  <p>Overall Height: 16.58 (421) End 1 OD: 9.60 (244) End 2 OD: 9.01 (229) End 2 ID: 5.71 (145)</p>
<p>AF1832 CASE 505633C1</p>  <p>Overall Height: 19.54 (496) End 1 OD: 16.26 (413) End 2 OD: 12.77 (324) End 2 ID: 8.36 (212)</p>	<p>AF1841 KAEUBLE 34000191, KHD(KLOCKNER-HUMBOLDT-DEUTZ) 2243946, VOLVO 4785746 Safety Element used with AF25065, AF971, AF25043M</p>  <p>Overall Height: 14.96 (380) End 1 OD: 4.76 (121) End 2 OD: 4.49 (114) End 1 ID: 3.92 (100) End 2 ID: 0.67 (17)</p>	<p>AF1848 CASE 494730C91 3311624 Bolt Seal Included</p>  <p>Overall Height: 17.72 (450) Overall OD: 12.08 (307) End 1 ID: 7.73 (196) End 2 ID: 0.67 (17)</p>
		<p>AF1849M STEIGER 13898, DRESSTA 1200454H1 Primary Air Filter used with AF881 3830497 Bolt Seal Included</p>  <p>Overall Height: 22.48 (571) Overall OD: 13.83 (351) End 1 ID: 9.48 (241) End 2 ID: 0.90 (23)</p>



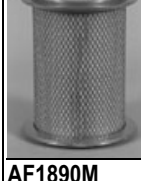

















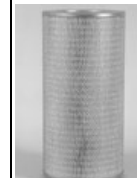

E. PRODUCT GUIDE

<p>AF1850</p>  <p>DONALDSON P150692 For element w/ attached cover use AF4562M</p> <p>Overall Height: 28.40 (721) End 1 OD: 8.66 (220) End 2 OD: 5.82 (148) End 1 ID: 5.21 (132)</p>	<p>AF1858</p>  <p>MASSEY-FERGUSON 1698374M1 Primary Air Filter used with AF1859</p> <p>Overall Height: 12.82 (326) End 1 OD: 7.44 (189) End 2 OD: 6.65 (169) End 1 ID: 0.34 (9) End 2 ID: 3.62 (92)</p>	<p>AF1866M</p>  <p>CASE 932391C1 Primary Air Filter used with AF1873 3311624 Bolt Seal Included</p> <p>Overall Height: 18.48 (469) End 1 OD: 9.20 (234) End 2 OD: 9.14 (232) End 1 ID: 0.67 (17) End 2 ID: 5.87 (149)</p>
<p>AF1851</p>  <p>J.C.B. 32203703 Safety Element used with AF1845K</p> <p>Overall Height: 11.04 (281) End 1 OD: 3.27 (83) End 2 OD: 2.72 (69) End 1 ID: 2.40 (61) End 2 ID: 0.67 (17)</p>	<p>AF1859</p>  <p>MASSEY-FERGUSON 1698375M1 Safety Element used with AF1858</p> <p>Overall Height: 11.65 (296) Overall OD: 3.50 (89) End 1 ID: 2.24 (57) End 2 ID: 0.34 (9)</p>	<p>AF1867</p>  <p>COOPERS AZA250T</p> <p>Overall Height: 19.24 (489) End 1 OD: 9.96 (253) End 2 OD: 8.50 (216) End 1 ID: 6.30 (160) End 2 ID: 0.69 (18)</p>
<p>AF1852</p>  <p>LISTER PETTER 36606227</p> <p>Overall Height: 2.52 (64) Overall OD: 5.79 (147) End 1 ID: 4.17 (106)</p>	<p>AF1860</p>  <p>LEYLAND AAU6096</p> <p>Overall Height: 15.21 (386) Overall OD: 6.65 (169) End 1 ID: 4.17 (106) End 2 ID: 0.41 (11)</p>	<p>AF1868</p>  <p>COOPERS AZA199T</p> <p>Overall Height: 20.54 (522) End 1 OD: 11.48 (292) End 2 OD: 9.21 (234) End 1 ID: 8.10 (206) End 2 ID: 0.67 (17)</p>
<p>AF1853KM</p>  <p>MOTORCRAFT AFA92 3830497 Bolt Seal Included</p> <p>Overall Height: 16.44 (418) Fin Diameter: 15.70 (399) End 2 OD: 12.08 (307) End 1 ID: 0.90 (23) End 2 ID: 7.73 (196)</p>	<p>AF1861K</p>  <p>CASE 3125342R1 Primary Air Filter used with AF4882</p> <p>Overall Height: 11.55 (293) Fin Diameter: 7.85 (200) End 2 OD: 6.08 (154) End 1 ID: 3.48 (88) End 2 ID: 0.67 (17)</p>	<p>AF1869</p>  <p>CATERPILLAR 4N0015</p> <p>Height: 5.54 (141) Length: 15.00 (381) Width: 15.00 (381)</p>
<p>AF1854</p>  <p>STEIGER 13899 3311624 Bolt Seal Included</p> <p>Overall Height: 20.99 (533) End 1 OD: 0.68 (17) End 2 OD: 8.64 (219) End 1 ID: 7.11 (181) End 2 ID: 8.63 (219)</p>	<p>AF1862M</p>  <p>JOHN DEERE T52223 Primary Air Filter used with AF1863M 3830497 Bolt Seal Included</p> <p>Overall Height: 15.47 (393) Overall OD: 10.86 (276) End 1 ID: 6.50 (165) End 2 ID: 0.92 (23)</p>	<p>AF1870</p>  <p>CASE 143481C91 For filter without gasket use AF1722</p> <p>Height: 2.19 (56) Length: 38.00 (965) Width: 6.00 (152)</p>
<p>AF1855</p>  <p>FORD D6NN9601B Primary Air Filter used with AF1835</p> <p>Overall Height: 14.95 (380) End 1 OD: 5.91 (150) End 2 OD: 5.24 (133) End 1 ID: 0.49 (13) End 2 ID: 3.17 (81)</p>	<p>AF1863M</p>  <p>JOHN DEERE T52224 Safety Element used with AF1862M 3311624 Bolt Seal Included</p> <p>Overall Height: 14.49 (368) End 1 OD: 0.67 (17) End 2 OD: 6.41 (163) End 1 ID: 5.27 (134) End 2 ID: 6.39 (162)</p>	<p>AF1871M</p>  <p>CROSLAND 9509 Same as AF361 w/attached gasket 250806 Bolt Seal Included</p> <p>Overall Height: 16.39 (416) Overall OD: 13.83 (351) End 1 ID: 9.48 (241) End 2 ID: 0.54 (14)</p>
<p>AF1856</p>  <p>MASSEY-FERGUSON 1698683M1 Primary Air Filter used with AF1857</p> <p>Overall Height: 9.15 (233) End 1 OD: 7.44 (189) End 2 OD: 6.65 (169) End 1 ID: 0.34 (9) End 2 ID: 3.62 (92)</p>	<p>AF1864</p>  <p>WHITE 220050010</p> <p>Overall Height: 18.55 (471) Flange Diameter: 16.23 (412) End 2 OD: 12.75 (324) End 2 ID: 7.43 (189)</p>	<p>AF1872</p>  <p>DONALDSON P123990 Uses service part: 3834340S 3311624 Bolt Seal Included</p> <p>Overall Height: 13.50 (343) Overall OD: 6.84 (174) End 1 ID: 3.48 (88) End 2 ID: 0.66 (17)</p>
<p>AF1857</p>  <p>MASSEY-FERGUSON 1698684M1 Safety Element used with AF1856</p> <p>Overall Height: 7.91 (201) Overall OD: 3.50 (89) End 1 ID: 2.24 (57) End 2 ID: 0.34 (9)</p>	<p>AF1865</p>  <p>RENAULT V.I. 3563576, RENAULT V.I. 4311087, FENDT X810270070, KRAMER 9930906</p> <p>Overall Height: 13.22 (336) Cover Diameter: 6.99 (178) End 2 OD: 5.87 (149) End 1 ID: 0.34 (9) End 2 ID: 2.82 (72)</p>	<p>AF1873</p>  <p>CASE 932390C1 Safety Element used with AF1866M 3311624 Bolt Seal Included</p> <p>Overall Height: 16.34 (415) End 1 OD: 0.67 (17) End 2 OD: 5.72 (145) End 1 ID: 4.56 (116) End 2 ID: 0.67 (17)</p>



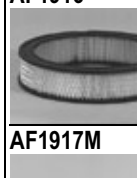



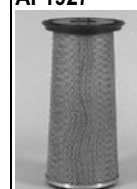





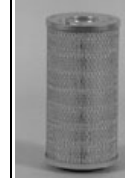

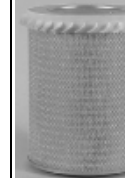

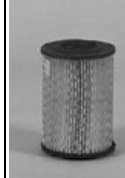

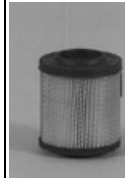

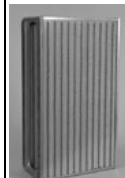
E. PRODUCT GUIDE

<p>AF1874 MACK 2MD3131</p>  <p>Overall Height: 4.31 (109) Largest OD: 3.69 (94) Thread Size: 3/4-20 UNEF-2B</p>	<p>AF1882 PERMATIC FA1443, RENAULT V.I. 5000807196</p>  <p>Overall Height: 16.45 (418) Cover Diameter: 14.74 (375) End 2 OD: 11.69 (297) End 1 ID: 0.47 (12) End 2 ID: 5.24 (133)</p>	<p>AF1891 CATERPILLAR 7N9027 Safety Element used with AF1890M</p>  <p>Overall Height: 6.57 (167) Flange Diameter: 6.70 (170) End 2 OD: 3.92 (100) End 2 ID: 2.38 (60)</p>
<p>AF1875M DONALDSON P133754</p>  <p>Gasket: 3312554 Overall Height: 16.94 (430) Overall OD: 12.77 (324) End 1 ID: 8.36 (212)</p>	<p>AF1883 FORD 81DB9601DB</p>  <p>Overall Height: 4.33 (110) Overall OD: 12.48 (317) End 1 ID: 8.54 (217)</p>	<p>AF1892 Safety Element used with AF1606KM, AF4800K, AF4888K Filter used with AH19064</p>  <p>Overall Height: 14.06 (357) End 1 OD: 3.62 (92) End 2 OD: 2.95 (75) End 1 ID: 2.42 (62) End 2 ID: 0.67 (17)</p>
<p>AF1876 CATERPILLAR 7G8116 3834340 Wing Nut Included</p>  <p>Overall Height: 7.55 (192) Overall OD: 6.08 (154) End 1 ID: 3.48 (88) Thread Size: 7/16-20 UNF-2B</p>	<p>AF1884KM GMC 6488354 Primary Air Filter used with AF1885 3311624 Bolt Seal Included</p>  <p>Overall Height: 15.51 (394) Fin Diameter: 13.80 (351) End 2 OD: 11.08 (281) End 1 ID: 0.67 (17) End 2 ID: 6.73 (171)</p>	<p>AF1893 FRAM CA230PLHD Pre- Cleaner Blanket is AF1844 Precleaner blanket is AF1844</p>  <p>Overall Height: 9.71 (247) Overall OD: 8.35 (212) End 1 ID: 5.14 (131)</p>
<p>AF1877 CATERPILLAR 2V0036</p>  <p>Gasket: 3312136 Overall Height: 9.52 (242) End 1 OD: 6.85 (174) End 2 ID: 4.23 (107)</p>	<p>AF1885 JOY 360628321 Safety Element used with AF1884KM 3311624 Bolt Seal Included</p>  <p>Overall Height: 15.11 (384) End 1 OD: 0.67 (17) End 2 OD: 6.41 (163) End 1 ID: 5.27 (134) End 2 ID: 6.40 (163)</p>	<p>AF1894M DONALDSON P124860 Safety Element used with AF1828 Filter used with AH19259 Pre- Cleaner Blanket is AF1844 3830497S Bolt Seal Included</p>  <p>Overall Height: 18.50 (470) End 1 OD: 0.90 (23) End 2 OD: 7.64 (194) End 1 ID: 0.88 (22) End 2 ID: 6.05 (154)</p>
<p>AF1878 CASE 588213C1</p>  <p>Overall Height: 6.95 (177) Overall OD: 11.56 (294) End 1 ID: 8.28 (210)</p>	<p>AF1886M FORD E2HZ9601B 3311624 Bolt Seal Included</p>  <p>Overall Height: 10.50 (267) Overall OD: 13.85 (352) End 1 ID: 7.44 (189) End 2 ID: 0.67 (17)</p>	<p>AF1895M DONALDSON P133050</p>  <p>Overall Height: 13.54 (344) End 1 OD: 16.26 (413) End 2 OD: 13.85 (352) End 2 ID: 7.44 (189)</p>
<p>AF1879 DAF 693099</p>  <p>Overall Height: 14.99 (381) Overall OD: 9.88 (251) End 1 ID: 5.51 (140)</p>	<p>AF1887M CASE 935694C1 Primary Air Filter used with AF907 3311624 Bolt Seal Included</p>  <p>Overall Height: 16.51 (419) Overall OD: 10.40 (264) End 1 ID: 6.05 (154) End 2 ID: 0.68 (17)</p>	<p>AF1896M GARDNER-DENVER 8507413 3311624 Bolt Seal Included</p>  <p>Overall Height: 13.50 (343) Overall OD: 10.40 (264) End 1 ID: 6.05 (154) End 2 ID: 0.68 (17)</p>
<p>AF1880 VOLVO 15178478</p>  <p>Overall Height: 12.67 (322) Overall OD: 6.54 (166) End 1 ID: 2.99 (76)</p>	<p>AF1888 FRAM CA240PLH Pre-Cleaner Blanket is AF1807 Complete assembly is AF1650</p>  <p>Overall Height: 11.71 (297) Overall OD: 9.61 (244) End 1 ID: 5.14 (131)</p>	<p>AF1897M WHITE 220053201</p>  <p>Overall Height: 15.95 (405) End 1 OD: 9.52 (242) End 2 OD: 13.79 (350) End 1 ID: 9.52 (242)</p>
<p>AF1881 RENAULT V.I. 5000560078</p>  <p>Overall Height: 14.83 (377) End 1 OD: 11.85 (301) End 2 OD: 8.70 (221) End 1 ID: 0.49 (13) End 2 ID: 4.74 (121)</p>	<p>AF1890M CATERPILLAR 8N5504 Primary Air Filter used with AF1891, AF4886</p>  <p>Overall Height: 5.78 (147) Overall OD: 8.39 (213) End 1 ID: 4.00 (102)</p>	<p>AF1898KM MOTORCRAFT AFA106 Primary Air Filter used with AF1899M 3830497 Bolt Seal Included</p>  <p>Overall Height: 18.52 (470) Fin Diameter: 15.80 (401) End 2 OD: 13.83 (351) End 1 ID: 0.90 (23) End 2 ID: 9.48 (241)</p>

E. PRODUCT GUIDE

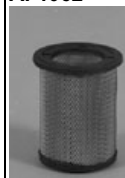
AF1899M  MOTORCRAFT AFA107 Safety Element used with AF1898KM 3311624 Bolt Seal Included Overall Height: 17.14 (435) Overall OD: 8.26 (210) End 1 ID: 7.10 (180) End 2 ID: 0.67 (17)	AF1908KM  DONALDSON P900023 3830497 Bolt Seal Included Overall Height: 15.55 (395) Fin Diameter: 15.50 (394) End 2 OD: 13.83 (351) End 1 ID: 0.90 (23) End 2 ID: 9.48 (241)	AF1918KM  ISUZU 9142151960 250806 Bolt Seal Included Overall Height: 12.25 (311) Fin Diameter: 7.80 (198) End 2 OD: 6.08 (154) End 1 ID: 3.48 (88) End 2 ID: 0.48 (12)
AF1900M  DONALDSON P123347 Overall Height: 12.02 (305) End 1 OD: 6.06 (154) End 1 ID: 8.04 (204)	AF1909  DONALDSON P900024 3311624 Bolt Seal Included Overall Height: 14.38 (365) End 1 OD: 7.16 (182) End 2 OD: 8.26 (210) End 1 ID: 7.10 (180) End 2 ID: 0.67 (17)	AF1919  INGERSOLL-RAND 59710368 256017 Bolt Seal Included 3839974 Wing Nut Included Overall Height: 27.04 (687) Boot Diameter: 15.77 (401) End 2 OD: 15.11 (384) End 1 ID: 0.85 (22) End 2 ID: 8.20 (208)
AF1901M  DONALDSON P128781 Overall Height: 23.51 (597) Overall OD: 12.77 (324) End 1 ID: 8.36 (212)	AF1910M  CASE 71912C2 Primary Air Filter used with AF988 Overall Height: 15.38 (391) End 1 OD: 6.85 (174) End 2 OD: 6.83 (174) End 2 ID: 3.48 (88)	AF1920  LISTER PETER 334402 Overall Height: 2.84 (72) Overall OD: 3.74 (95) End 1 ID: 1.93 (49)
AF1902M  KOMATSU 6001812350 Safety Element used with AF1903M 256017 Bolt Seal Included Overall Height: 13.55 (344) Overall OD: 5.07 (129) End 1 ID: 3.83 (97) End 2 ID: 0.65 (17)	AF1913  KOHLER 253107 Overall Height: 5.91 (150) Overall OD: 7.88 (200) End 1 ID: 4.13 (105)	AF1921M  KOMATSU 5610212330 Primary Air Filter used with AF1922M 3830497 Bolt Seal Included Overall Height: 24.46 (621) Overall OD: 12.08 (307) End 1 ID: 7.73 (196) End 2 ID: 0.90 (23)
AF1903M  KOMATSU 6001812300 Primary Air Filter used with AF1902M Overall Height: 15.57 (395) Overall OD: 9.65 (245) End 1 ID: 5.25 (133)	AF1914  BEDFORD 7972962 Overall Height: 14.55 (370) End 1 OD: 6.44 (164) End 2 OD: 6.42 (163) End 2 ID: 3.90 (99)	AF1922M  KOMATSU 5610212320 Safety Element used with AF1921M 3311624 Bolt Seal Included Overall Height: 23.53 (598) End 1 OD: 7.30 (185) End 2 OD: 7.28 (185) End 1 ID: 0.67 (17) End 2 ID: 6.19 (157)
AF1904M  KOMATSU 6001814212 Safety Element used with AF1905M Overall Height: 16.11 (409) End 1 OD: 7.59 (193) End 2 OD: 6.40 (163) End 1 ID: 5.28 (134) End 2 ID: 0.67 (17)	AF1915  CATERPILLAR 8P5343 Height: 2.19 (56) Length: 23.50 (597) Width: 6.00 (152)	AF1925K  HINO 178011720 Overall Height: 11.65 (296) Fin Diameter: 9.09 (231) End 2 OD: 7.87 (200) End 1 ID: 3.94 (100) End 2 ID: 0.51 (13)
AF1905M  KOMATSU 6001814300 Primary Air Filter used with AF1904M Overall Height: 16.58 (421) End 1 OD: 11.12 (282) End 2 OD: 11.08 (281) End 2 ID: 6.73 (171)	AF1916  FORD E3TZ9601H Overall Height: 2.17 (55) Overall OD: 9.92 (252) End 1 ID: 8.03 (204)	AF1926  MITSUBISHI ME021214 Overall Height: 11.60 (295) Overall OD: 8.81 (224) End 1 ID: 5.69 (144)
AF1907M  FILTER CLONE FC3R1001, FILTER CLONE 128495 3830497 Bolt Seal Included Overall Height: 26.47 (672) Overall OD: 10.40 (264) End 1 ID: 6.05 (154) End 2 ID: 0.90 (23)	AF1917M  CASE A47137, JOHN DEERE AT39124 Primary Air Filter used with AF487 3311624 Bolt Seal Included Overall Height: 12.50 (318) Overall OD: 9.21 (234) End 1 ID: 4.86 (123) End 2 ID: 0.67 (17)	AF1927  LEYLAND ACU3994, E.R.F. 943042 Overall Height: 19.06 (484) Cover Diameter: 9.41 (239) End 2 OD: 8.66 (220) End 1 ID: 5.16 (131) Thread Size: M10 X 1.5-6H INT

E. PRODUCT GUIDE

AF1929  Primary Air Filter used with AF804M Overall Height: 16.37 (416) Overall OD: 9.21 (234) End 1 ID: 4.86 (123) End 2 ID: 0.67 (17)	AF1946M  MACK 57MD37M, CHAMP 1523443, LUBERFINER 1523443 Overall Height: 22.53 (572) End 2 OD: 13.85 (352) End 2 ID: 7.44 (189)	AF1954  MASSEY-FERGUSON 1094056M1 Primary Air Filter used with AF1687 250806 Bolt Seal Included Overall Height: 10.87 (276) Overall OD: 5.32 (135) End 1 ID: 2.21 (56) End 2 ID: 0.40 (10)
AF1930  WABCO VE0539 Height: 2.19 (56) Length: 26.00 (660) Width: 11.00 (279)	AF1947  GMC 2026736 3311624 Bolt Seal Included Overall Height: 12.02 (305) Cover Diameter: 11.87 (302) End 2 OD: 11.07 (281) End 1 ID: 0.64 (16) End 2 ID: 7.25 (184)	AF1955KM  GROVE 9304100072 3311624 Bolt Seal Included Overall Height: 18.55 (471) Fin Diameter: 15.80 (401) End 2 OD: 13.83 (351) End 1 ID: 0.67 (17) End 2 ID: 9.48 (241)
AF1934M  CASE S238646 Primary Air Filter used with AF1935M 3830497 Bolt Seal Included Overall Height: 18.48 (469) Overall OD: 9.14 (232) End 1 OD: 9.19 (233) End 1 ID: 5.87 (149) End 2 ID: 0.90 (23)	AF1948  CASE 405716R1, CASE 405716R2 Overall Height: 6.14 (156) Overall OD: 4.20 (107) End 1 ID: 2.00 (51)	AF1956KM  MASSEY-FERGUSON 1043326M1 Primary Air Filter used with AF1966 3311624 Bolt Seal Included Gasket: 3301542 Overall Height: 11.43 (290) Fin Diameter: 6.44 (164) End 2 OD: 5.24 (133) End 1 ID: 0.67 (17) End 2 ID: 2.71 (69)
AF1935M  DONALDSON P124046 Safety Element used with AF1934M 3311624 Bolt Seal Included Overall Height: 17.48 (444) End 1 OD: 0.65 (17) End 2 OD: 5.72 (145) End 1 ID: 4.56 (116)	AF1949  EUCLID 9023871 Overall Height: 3.62 (92) Overall OD: 3.06 (78) End 1 ID: 1.56 (40)	AF1960  MASSEY-FERGUSON 1698675M1 Primary Air Filter used with AF1961 Overall Height: 9.45 (240) End 1 OD: 4.53 (115) End 2 OD: 4.25 (108) End 1 ID: 0.39 (10) End 2 ID: 2.64 (67)
AF1942  NELSON 70475N Overall Height: 13.99 (355) End 1 OD: 3.60 (91) End 2 OD: 2.71 (69) End 1 ID: 2.39 (61) End 2 ID: 0.67 (17)	AF1950  EUCLID 9034697 Height: 18.50 (470) Length: 31.00 (787) Width: 10.80 (274)	AF1961  MASSEY-FERGUSON 1698676M1 Safety Element used with AF1960 Overall Height: 8.23 (209) End 1 OD: 2.60 (66) End 2 OD: 2.58 (66) End 1 ID: 1.61 (41) End 2 ID: 0.34 (9)
AF1943M  WHITE 220053202 Overall Height: 16.00 (406) Overall OD: 12.08 (307) End 1 ID: 7.73 (196)	AF1951  TORIT S102235 Overall Height: 26.44 (672) Overall OD: 12.76 (324) End 1 ID: 8.43 (214) End 2 ID: 0.55 (14)	AF1962  KOMATSU 6001812500 Primary Air Filter used with AF1963 Overall Height: 13.15 (334) Overall OD: 9.76 (248) End 1 ID: 5.65 (144) Thread Size: M10 X 1.5-6H INT
AF1944  NELSON 83887N Height: 2.13 (54) Length: 16.88 (429) Width: 7.88 (200)	AF1952  TOWMOTOR 358896 Overall Height: 3.97 (101) End 1 OD: 3.25 (83) End 2 OD: 2.94 (75) End 1 ID: 2.00 (51)	AF1963  KOMATSU 6001812461 Safety Element used with AF1962 Overall Height: 10.95 (278) Overall OD: 5.51 (140) End 1 ID: 4.23 (108) End 2 ID: 0.63 (16)
AF1945  COOPERS AZA251T Overall Height: 14.49 (368) End 1 OD: 7.48 (190) End 2 OD: 6.46 (164) End 1 ID: 0.65 (17) End 2 ID: 3.84 (98)	AF1953  IVECO 1901601 Overall Height: 4.96 (126) Overall OD: 6.34 (161) End 1 ID: 4.49 (114)	AF1965M  MACK 2191P138427 3317119 Wing Nut 3311624 Bolt Seal Included Gasket: 3318734 Overall Height: 15.55 (395) End 1 OD: 9.83 (250) End 2 OD: 8.66 (220) End 1 ID: 0.67 (17) End 2 ID: 5.21 (132)

E. PRODUCT GUIDE

AF1966 MASSEY-FERGUSON
1043327M91 Safety Element
used with AF1956KM,
AF4887KM



Overall Height: 10.08 (256)
End 1 OD: 3.05 (77)
End 2 OD: 2.59 (66)
End 1 ID: 2.15 (55)
End 2 ID: 0.66 (17)

AF1967 NELSON A12871 3830497 Bolt
Seal Included

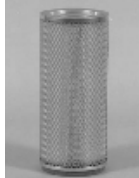

Overall Height: 14.50 (368)
End 1 OD: 0.90 (23)
End 2 OD: 6.29 (160)
End 1 ID: 4.60 (117)

AF1968 DONALDSON P153551 For
Upgrade, use AF1968M,
AF26328



Overall Height: 22.40 (569)
End 1 OD: 11.67 (296)
End 2 OD: 10.59 (269)
End 2 ID: 6.71 (170)

AF1968M DONALDSON P185053
Upgrade of AF1968 For
Upgrade, use AF26328M



Overall Height: 22.40 (569)
Cover Diameter: 11.67 (296)
End 2 OD: 10.59 (269)
End 2 ID: 6.71 (170)

AF1969 DONALDSON P150695 For
Upgrade, use AF1969M



Overall Height: 28.40 (721)
Cover Diameter: 11.67 (296)
End 2 OD: 10.59 (269)
End 2 ID: 6.71 (170)

AF1969M DONALDSON P185047
Upgrade of AF1969



Overall Height: 28.40 (721)
Cover Diameter: 11.67 (296)
End 2 OD: 10.59 (269)
End 2 ID: 6.71 (170)

AF1971 PERMATIC FA1068



Overall Height: 20.00 (508)
Cover Diameter: 16.58 (421)
End 2 OD: 11.24 (286)
End 1 ID: 0.20 (5)
End 2 ID: 6.12 (156)

AF1972 KOHLER 277138



Overall Height: 4.08 (104)
Overall OD: 6.07 (154)
End 1 ID: 4.68 (119)

AF1973 MOTORCRAFT FA1041



Overall Height: 6.97 (177)
Overall OD: 11.71 (297)
End 1 ID: 8.33 (212)

AF1974 TOYOTA 178012200071



Overall Height: 3.50 (89)
Overall OD: 7.38 (187)
End 1 ID: 4.31 (110)

AF1975 TOYOTA 233013020571



Overall Height: 5.70 (145)
Overall OD: 7.68 (195)
End 1 ID: 3.32 (84)

AF1976 THERMO-KING 120404



Overall Height: 10.16 (258)
End 1 OD: 5.94 (151)
End 2 OD: 5.27 (134)
End 1 ID: 0.55 (14)
End 2 ID: 3.12 (79)

AF1977M DONALDSON SMP181162



Overall Height: 10.51 (267)
Overall OD: 10.40 (264)
End 1 ID: 6.05 (154)

AF1978 MANN & HUMMEL C1450



Overall Height: 4.84 (123)
Overall OD: 5.43 (138)
End 1 ID: 3.15 (80)

AF1979 CATERPILLAR 9P5174



Height: 0.88 (22)
Length: 13.25 (337)
Width: 12.00 (305)

AF1980 JOHN DEERE AT44378 Safety
Element used with AF4736,
AF409K



Overall Height: 11.00 (279)
Flange Diameter: 4.07 (103)
End 2 OD: 3.44 (87)
End 1 ID: 2.88 (73)
End 2 ID: 0.66 (17)

AF1982 KOHLER 4508302

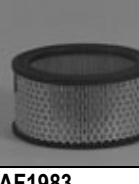

Overall Height: 3.08 (78)
Overall OD: 6.07 (154)
End 1 ID: 4.68 (119)

AF1983 FORD E3TZ9601C For
element w/o foam wrap use
AF1731



Overall Height: 5.00 (127)
Overall OD: 12.51 (318)
End 1 ID: 8.28 (210)

AF1984K HUBER-WARCO 104873
3311624 Bolt Seal Included



Overall Height: 16.26 (413)
Fin Diameter: 7.70 (196)
End 2 OD: 6.08 (154)
End 1 ID: 3.48 (88)
End 2 ID: 0.67 (17)

AF1985 AC A644C Same as AF1628
with foam precleaner



Overall Height: 4.69 (119)
Overall OD: 14.88 (378)
End 1 ID: 11.62 (295)

AF1986 DONALDSON P105958



Height: 2.75 (70)
Length: 10.00 (254)
Width: 10.00 (254)

AF1987 DONALDSON P137523



Height: 2.19 (56)
Length: 15.00 (381)
Width: 7.00 (178)

AF1988 JOHN DEERE AH61904



Height: 2.57 (65)
Length: 15.00 (381)
Width: 15.00 (381)

AF4018 FORD 2720E9601A















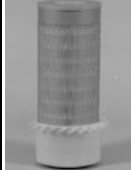







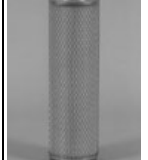



Overall Height: 2.24 (57)
Overall OD: 9.57 (243)
End 1 ID: 7.40 (188)

AF4021 ROLLS ROYCE OE17616





















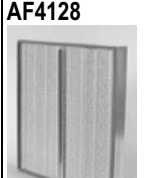
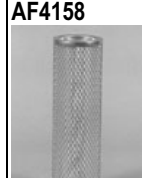

Overall Height: 7.54 (192)
Overall OD: 8.07 (205)
End 1 ID: 5.77 (147)
End 2 ID: 0.43 (11)





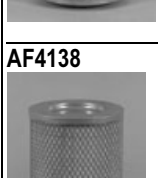
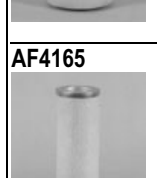

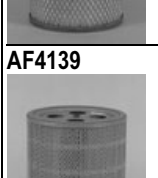
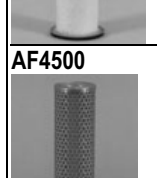



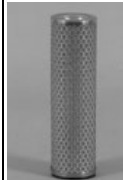

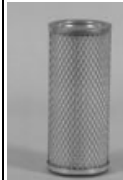



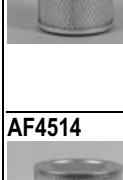

E. PRODUCT GUIDE

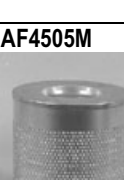
AF4022 GARDNER MA410  Overall Height: 2.30 (59) Overall OD: 2.80 (71) End 1 ID: 1.32 (34)	AF4041 PERKINS 26510167  Overall Height: 10.43 (265) End 1 OD: 5.45 (138) End 2 OD: 5.43 (138) End 2 ID: 2.86 (73)	AF4059K LEYLAND 37H3739 Primary Air Filter used with AF1680, AF4103 Filter used with AH19065, AH19066 3311624 Bolt Seal Included  Overall Height: 15.35 (390) Fin Diameter: 7.85 (200) End 2 OD: 6.08 (154) End 1 ID: 3.48 (88) End 2 ID: 0.67 (17)
AF4023 SCANIA 709457  Overall Height: 5.02 (128) Overall OD: 5.63 (143) End 1 ID: 3.45 (88)	AF4044 GMC 7972972  Overall Height: 14.43 (366) End 1 OD: 7.73 (196) End 2 OD: 7.71 (196) End 2 ID: 5.09 (129)	AF4060 SCANIA 219517 Primary Air Filter used with AF1843 250806 Bolt Seal Included  Overall Height: 19.59 (497) Overall OD: 9.55 (243) End 1 ID: 5.19 (132) End 2 ID: 0.41 (11)
AF4024 ROLLS ROYCE UE9813  Overall Height: 4.04 (103) Overall OD: 8.27 (210) End 1 ID: 5.88 (149)	AF4046 COOPERS DU2065T  Overall Height: 18.46 (469) End 1 OD: 6.18 (157) End 2 OD: 5.24 (133) End 2 ID: 2.72 (69)	AF4061 LEYLAND 37H6186  Overall Height: 11.35 (288) End 1 OD: 6.18 (157) End 2 OD: 5.26 (134) End 2 ID: 2.71 (69)
AF4026 CUMMINS 701646  Overall Height: 15.80 (401) Overall OD: 11.54 (293) End 1 ID: 7.41 (188)	AF4047 FIAT-ALLIS 78822161 250806 Bolt Seal Included  Overall Height: 15.49 (394) End 1 OD: 4.77 (121) End 2 OD: 4.48 (114) End 1 ID: 3.52 (89) End 2 ID: 0.35 (9)	AF4064 J.C.B. 98800031  Overall Height: 11.20 (285) Overall OD: 4.76 (121) End 1 ID: 2.13 (54) End 2 ID: 0.37 (10)
AF4027 VOLVO 347436  Overall Height: 10.43 (265) Overall OD: 8.51 (216) End 1 ID: 6.06 (154) End 2 ID: 0.41 (10)	AF4049 GMC 7980474  Height: 1.20 (31) Length: 4.86 (124) Width: 12.72 (323)	AF4065 LEYLAND 37H6187  Overall Height: 15.55 (395) End 1 OD: 6.18 (157) End 2 OD: 5.24 (133) End 2 ID: 2.72 (69)
AF4028 CUMMINS 650931, LEYLAND 37H3737 3311624 Bolt Seal Included  Overall Height: 13.56 (344) Overall OD: 7.93 (201) End 1 ID: 3.58 (91) End 2 ID: 0.67 (17)	AF4050 COOPERS 8465T  Overall Height: 7.11 (181) Overall OD: 8.11 (206) End 1 ID: 4.25 (108)	AF4066 MANN & HUMMEL C11763 250806 Bolt Seal Included  Overall Height: 8.93 (227) Overall OD: 4.35 (111) End 1 ID: 1.97 (50) End 2 ID: 0.34 (9)
AF4035 CUMMINS 701645  Overall Height: 12.49 (317) Overall OD: 9.85 (250) End 1 ID: 5.83 (148)	AF4057 MANN & HUMMEL C234402  Overall Height: 11.57 (294) Overall OD: 8.98 (228) End 1 ID: 4.58 (116) End 2 ID: 0.41 (10)	AF4067 MANN & HUMMEL C131144 Primary Air Filter used with AF4521 250806 Bolt Seal Included  Overall Height: 11.58 (294) Overall OD: 4.96 (126) End 1 ID: 2.52 (64) End 2 ID: 0.34 (9)
AF4039 VOLVO 347437  Overall Height: 10.95 (278) Overall OD: 10.55 (268) End 1 ID: 7.68 (195)	AF4058 KHD(KLOCKNER-HUMBOLDT-DEUTZ) 2165044 Primary Air Filter used with AF1842 250806 Bolt Seal Included  Overall Height: 13.81 (351) Overall OD: 6.44 (164) End 1 ID: 3.40 (86) End 2 ID: 0.34 (9)	AF4073 GMC 7955307  Overall Height: 8.03 (204) Overall OD: 8.31 (211) End 1 ID: 6.02 (153)

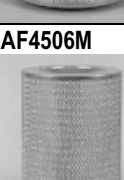

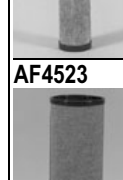

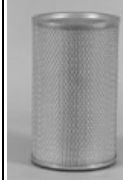





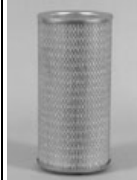









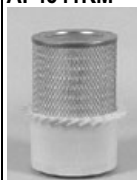

E. PRODUCT GUIDE

<p>AF4074 FIAT-ALLIS 8322121</p>  <p>Overall Height: 6.85 (174) Overall OD: 5.35 (136) End 1 ID: 3.98 (101)</p>	<p>AF4106 LISTER PETER ZPF356</p>  <p>Overall Height: 2.52 (64) Overall OD: 5.43 (138) End 1 ID: 3.13 (80)</p>	<p>AF4149 SCANIA 261185</p>  <p>Overall Height: 18.72 (476) Cover Diameter: 14.96 (380) End 2 OD: 11.88 (302) End 1 ID: 0.41 (11) End 2 ID: 7.55 (192)</p>
<p>AF4076 WELLWORTHY WS526902</p>  <p>Overall Height: 4.45 (113) Overall OD: 10.00 (254) End 1 ID: 5.59 (142)</p>	<p>AF4124 MERCEDES-BENZ 945804</p>  <p>Overall Height: 8.82 (224) Overall OD: 5.91 (150) End 1 ID: 3.47 (88)</p>	<p>AF4150 DONALDSON P119778 Safety Element used with AF1735K, AF4643</p>  <p>Overall Height: 15.06 (383) End 1 OD: 4.84 (123) End 2 OD: 4.09 (104) End 1 ID: 3.66 (93) End 2 ID: 0.67 (17)</p>
<p>AF4078 FIAT-ALLIS 8322122</p>  <p>Overall Height: 8.19 (208) Overall OD: 8.51 (216) End 1 ID: 6.06 (154)</p>	<p>AF4125 LISTER PETER AAF4996</p>  <p>Overall Height: 2.09 (53) Overall OD: 3.39 (86) End 1 ID: 1.91 (48)</p>	<p>AF4152 LEYLAND 10906354 3311624 Bolt Seal Included</p>  <p>Overall Height: 24.74 (628) Overall OD: 7.98 (203) End 1 ID: 4.64 (118) End 2 ID: 0.63 (16)</p>
<p>AF4083 E.R.F. 932833, GARDNER MA410</p>  <p>Overall Height: 3.31 (84) Overall OD: 3.39 (86) End 1 ID: 1.50 (38)</p>	<p>AF4128 CATERPILLAR 6L4714</p>  <p>Height: 2.69 (68) Length: 24.00 (610) Width: 24.00 (610)</p>	<p>AF4158 KOMATSU 6691817310 Safety Element used with AF4159 3311624 Bolt Seal Included</p>  <p>Overall Height: 14.94 (380) End 1 OD: 5.81 (148) End 2 OD: 4.61 (117) End 1 ID: 3.54 (90) End 2 ID: 0.67 (17)</p>
<p>AF4084 VOLVO 475230</p>  <p>Overall Height: 8.86 (225) Overall OD: 13.15 (334) End 1 ID: 8.13 (207)</p>	<p>AF4135 MANN & HUMMEL C151653 Primary Air Filter used with AF4522 250806 Bolt Seal Included</p>  <p>Overall Height: 13.22 (336) Overall OD: 5.87 (149) End 1 ID: 2.82 (72) End 2 ID: 0.34 (9)</p>	<p>AF4159 KOMATSU 6691817210 Primary Air Filter used with AF4158 3311624 Bolt Seal Included</p>  <p>Overall Height: 15.50 (394) Overall OD: 9.21 (234) End 1 ID: 4.86 (123) End 2 ID: 0.67 (17)</p>
<p>AF4088 ATLAS COPCO 10300832</p>  <p>Overall Height: 4.33 (110) Overall OD: 11.97 (304) End 1 ID: 7.52 (191)</p>	<p>AF4137 KHD(KLOCKNER-HUMBOLDT-DEUTZ) 2339813, KHD(KLOCKNER-HUMBOLDT-DEUTZ) 2311565 Primary Air Filter used with AF25424, AF25490</p>  <p>Overall Height: 8.21 (209) Overall OD: 6.44 (164) End 1 ID: 3.39 (86)</p>	<p>AF4164K DONALDSON P124164 Primary Air Filter used with AF4165 3311624 Bolt Seal Included</p>  <p>Overall Height: 13.38 (340) Fin Diameter: 7.80 (198) End 2 OD: 6.08 (154) End 1 ID: 3.48 (88) End 2 ID: 0.67 (17)</p>
<p>AF4100 VOLVO 823701</p>  <p>Overall Height: 28.03 (712) Overall OD: 7.72 (196) End 1 ID: 3.98 (101)</p>	<p>AF4138 CASE 351585R91 3311624 Bolt Seal Included</p>  <p>Overall Height: 9.06 (230) End 1 OD: 6.85 (174) End 2 OD: 6.83 (174) End 1 ID: 0.67 (17) End 2 ID: 4.23 (107)</p>	<p>AF4165 DONALDSON P124165 Safety Element used with AF4164K, AF25348K, AF25342</p>  <p>Overall Height: 12.07 (307) End 1 OD: 3.74 (95) End 2 OD: 3.35 (85) End 1 ID: 2.95 (75) End 2 ID: 0.67 (17)</p>
<p>AF4103 MASSEY-FERGUSON 1093683M91, INGERSOLL-RAND 59155135 Safety Element used with AF1733K, AF4748K, AF4853K, AF4892K, AF4856M, AF4059K, AF1733KM Filter used with AH19066, AH19267 Inner Air on JCB applications Bolt Seal Included</p>  <p>Overall Height: 14.04 (357) End 1 OD: 4.13 (105) End 2 OD: 3.35 (85) End 1 ID: 2.95 (75) End 2 ID: 0.67 (17)</p>	<p>AF4139 CUMMINS 105067</p>  <p>Overall Height: 12.17 (309) Overall OD: 10.40 (264) End 1 ID: 7.80 (198) End 2 ID: 0.43 (11)</p>	<p>AF4500 MASSEY-FERGUSON 1678295M1 Safety Element used with AF4501, AF4569</p>  <p>Overall Height: 11.50 (292) Overall OD: 2.91 (74) End 1 ID: 1.87 (48) End 2 ID: 0.34 (9)</p>

E. PRODUCT GUIDE

<p>AF4501 MASSEY-FERGUSON 1678294M1 Primary Air Filter used with AF4500</p>  <p>Overall Height: 12.68 (322) End 1 OD: 5.75 (146) End 2 OD: 5.20 (132) End 1 ID: 0.37 (10) End 2 ID: 2.97 (76)</p>	<p>AF4511 CASE E43789 Safety Element used with AF4557K</p>  <p>Overall Height: 10.20 (259) End 1 OD: 2.91 (74) End 2 OD: 2.84 (72) End 1 ID: 0.34 (9) End 2 ID: 1.85 (47)</p>	<p>AF4516M Replacement Element For Kit To Convert CAT 7N1308 Use With Bracket: AK00007 Extended Life Version of AF4516 3311624 Bolt Seal Included</p>  <p>Overall Height: 14.23 (361) End 1 OD: 0.68 (17) End 2 OD: 8.65 (220) End 1 ID: 6.69 (170) End 2 ID: 0.65 (17)</p>
<p>AF4502K KUBOTA 1585211080</p>  <p>Overall Height: 7.21 (183) Cover Diameter: 4.90 (125) Fin Diameter: 4.17 (106) End 1 ID: 0.44 (11) End 2 ID: 1.79 (46)</p>	<p>AF4512 Replacement Element For Kit To Convert CAT 2S1285 Use With Bracket: AK00001 -To Convert CAT 8N4901 Use With Bracket AK00009 3311624 Bolt Seal Included</p>  <p>Overall Height: 11.25 (286) End 1 OD: 4.77 (121) End 2 OD: 4.75 (121) End 1 ID: 3.52 (89) End 2 ID: 0.68 (17)</p>	<p>AF4517 WHITE 7761170</p>  <p>Height: 2.19 (56) Length: 17.00 (432) Width: 15.00 (381)</p>
<p>AF4503 IVECO 1902129 Seal included.</p>  <p>Overall Height: 18.72 (476) End 1 OD: 11.88 (302) End 2 OD: 11.84 (301) End 1 ID: 7.55 (192) End 2 ID: 0.41 (11)</p>	<p>AF4513 Replacement Element For Kit To Convert CAT 2S1286 Use With Bracket AK00002; -To Convert CAT 9S9972 Use With Bracket AK00003 3311624 Bolt Seal Included</p>  <p>Overall Height: 12.25 (311) End 1 OD: 0.68 (17) End 2 OD: 6.30 (160) End 1 ID: 4.60 (117) End 2 ID: 0.68 (17)</p>	<p>AF4518 MITSUBISHI ME0120389</p>  <p>Overall Height: 5.04 (128) End 1 OD: 9.41 (239) End 2 OD: 8.86 (225) End 1 ID: 0.47 (12) End 2 ID: 5.59 (142)</p>
<p>AF4504M KOMATSU 6001814400, NEW HOLLAND 76570088, FIAT HITACHI 76570088 Primary Air Filter used with AF1791 3830497 Bolt Seal Included</p>  <p>Overall Height: 18.70 (475) Cover Diameter: 14.86 (378) End 2 OD: 12.08 (307) End 1 ID: 0.94 (24) End 2 ID: 7.73 (196)</p>	<p>AF4514 Replacement Element For Kit To Convert CAT 1P7360 And 4S8340 Use With Bracket: AK00005 3311624 Bolt Seal Included</p>  <p>Overall Height: 12.25 (311) End 1 OD: 0.68 (17) End 2 OD: 7.64 (194) End 1 ID: 0.68 (17) End 2 ID: 5.71 (145)</p>	<p>AF4521 KHD(KLOCKNER-HUMBOLDT-DEUTZ) 4144896, IHC 314080R1 Safety Element used with AF4067</p>  <p>Overall Height: 11.20 (285) End 1 OD: 2.76 (70) End 2 OD: 2.44 (62) End 1 ID: 1.87 (48) End 2 ID: 0.67 (17)</p>
<p>AF4505M FORD D6HZ9601A 250806 Bolt Seal Included</p>  <p>Overall Height: 9.15 (232) Overall OD: 9.21 (234) End 1 ID: 0.54 (14) End 2 ID: 4.85 (123)</p>	<p>AF4515 Replacement Element For Kit To Convert CAT 6N6444 Use With Bracket: AK00006 3311624 Bolt Seal Included</p>  <p>Overall Height: 11.25 (286) End 1 OD: 0.68 (17) End 2 OD: 8.64 (219) End 1 ID: 6.69 (170)</p>	<p>AF4522 LIEBHERR 7002402, ATLAS COPCO 16195441 Safety Element used with AF4135</p>  <p>Overall Height: 12.85 (327) End 1 OD: 3.19 (81) End 2 OD: 2.72 (69) End 1 ID: 2.15 (55) End 2 ID: 0.67 (17)</p>
<p>AF4506M KOMATSU 6001814200 Primary Air Filter used with AF471 3317119 Wing Nut Included 256017 Bolt Seal Included</p>  <p>Overall Height: 18.49 (470) End 1 OD: 12.08 (307) End 2 OD: 12.09 (307) End 2 ID: 7.73 (196)</p>	<p>AF4516 Replacement Element For Kit To Convert CAT 1P8482 Use With Bracket AK00007; -To Convert CAT 3S4745 Use With Bracket AK00008 3311624 Bolt Seal Included For Magnum Version use AF4516M</p>  <p>Overall Height: 14.23 (361) End 1 OD: 0.68 (17) End 2 OD: 8.65 (220) End 1 ID: 6.69 (170) End 2 ID: 0.65 (17)</p>	<p>AF4523 INGERSOLL-RAND 92035955 Safety Element used with AF1802</p>  <p>Overall Height: 18.50 (470) End 1 OD: 6.38 (162) End 2 OD: 6.10 (155) End 1 ID: 5.53 (141) End 2 ID: 0.67 (17)</p>
<p>AF4509 TOYOTA 1780168020</p>  <p>Overall Height: 5.75 (146) Overall OD: 8.58 (218) End 1 ID: 4.29 (109)</p>	<p>AF4510 CASE E41535 Safety Element used with AF437K, AF437KM</p>  <p>Overall Height: 10.75 (273) Overall OD: 2.60 (66) End 1 ID: 2.21 (56) End 2 ID: 0.34 (9)</p>	<p>AF4525 CROSLAND 9009</p>  <p>Overall Height: 2.76 (70) Overall OD: 3.84 (98) End 1 ID: 2.38 (61)</p>

E. PRODUCT GUIDE

<p>AF4526 Replacement Element For Kit To Convert CAT 2S1287 Use With Bracket AK00004 -To Convert CAT 8N-6883 Use With Bracket AK00012 3311624 Bolt Seal Included</p>  <p>Overall Height: 14.23 (361) End 1 OD: 0.68 (17) End 2 OD: 6.29 (160) End 1 ID: 4.60 (117) End 2 ID: 0.68 (17)</p>	<p>AF4534 FORD E6HZ9601A</p>  <p>Overall Height: 16.36 (416) Overall OD: 7.93 (201) End 1 ID: 5.33 (135) End 2 ID: 0.67 (17)</p>	<p>AF4548 CASE 573640C1</p>  <p>Overall Height: 22.50 (572) End 1 OD: 10.40 (264) End 2 OD: 7.49 (190) End 1 ID: 6.95 (177)</p>
<p>AF4527M SISU 1293400121</p>  <p>Overall Height: 28.87 (733) End 1 OD: 8.66 (220) End 2 OD: 5.75 (146) End 1 ID: 5.12 (130)</p>	<p>AF4535M GMC 15527863</p>  <p>Overall Height: 20.38 (518) Cover Diameter: 11.73 (298) End 2 OD: 10.59 (269) End 2 ID: 6.71 (170)</p>	<p>AF4549 VOLVO 6897063 Primary Air Filter used with AF4551</p>  <p>Overall Height: 22.87 (581) End 1 OD: 10.63 (270) End 2 OD: 10.59 (269) End 1 ID: 0.67 (17) End 2 ID: 7.28 (185)</p>
<p>AF4528M SISU 1293400192</p>  <p>Overall Height: 28.78 (731) End 1 OD: 10.40 (264) End 2 OD: 7.51 (191) End 1 ID: 6.95 (177)</p>	<p>AF4536 CATERPILLAR 2W4246</p>  <p>Overall Height: 5.52 (140) Overall OD: 6.83 (174) End 1 ID: 4.23 (107)</p>	<p>AF4550 VOLVO 1660376 Primary Air Filter used with AF4552</p>  <p>Overall Height: 22.87 (581) End 1 OD: 10.63 (270) End 2 OD: 10.59 (269) End 1 ID: 0.41 (10) End 2 ID: 7.28 (185)</p>
<p>AF4529 CROSLAND 9505 Same as AF354 w/gasket</p>  <p>Overall Height: 9.43 (240) Overall OD: 10.40 (264) End 1 ID: 6.05 (154) End 2 ID: 0.54 (14)</p>	<p>AF4539 NELSON 70456N w/Foam Precleaner</p>  <p>Overall Height: 10.90 (277) Overall OD: 8.00 (203) End 1 ID: 5.38 (137)</p>	<p>AF4551 VOLVO 6897064 Safety Element used with AF4549</p>  <p>Overall Height: 21.56 (548) End 1 OD: 7.11 (181) End 2 OD: 7.07 (180) End 1 ID: 0.67 (17) End 2 ID: 5.51 (140)</p>
<p>AF4530 MASSEY-FERGUSON 1613731M1, CASE 702642C1 Safety Element used with AF4531 3311624 Bolt Seal Included</p>  <p>Overall Height: 16.02 (407) End 1 OD: 0.67 (17) End 2 OD: 5.41 (137) End 1 ID: 4.10 (104) End 2 ID: 5.41 (137)</p>	<p>AF4540 RENAULT V.I. 5000802163</p>  <p>Overall Height: 16.59 (422) End 1 OD: 9.36 (238) End 2 OD: 7.11 (181) End 1 ID: 0.36 (9) End 2 ID: 4.16 (106)</p>	<p>AF4552 VOLVO 1660377 Safety Element used with AF4550</p>  <p>Overall Height: 21.44 (545) End 1 OD: 6.73 (171) End 2 OD: 6.69 (170) End 1 ID: 0.41 (10) End 2 ID: 5.51 (140)</p>
<p>AF4531 MASSEY-FERGUSON 1613732M1, CASE 702641C1 Primary Air Filter used with AF4530 250806 Bolt Seal Included</p>  <p>Overall Height: 17.56 (446) Overall OD: 10.02 (255) End 1 ID: 5.48 (139) End 2 ID: 0.40 (10)</p>	<p>AF4541KM JOHN DEERE AT43870 Primary Air Filter used with AF487 3311624 Bolt Seal Included</p>  <p>Overall Height: 12.50 (318) Fin Diameter: 10.70 (272) End 2 OD: 7.93 (201) End 1 ID: 5.33 (135) End 2 ID: 0.67 (17)</p>	<p>AF4553M ONAN 1401654 Primary Air Filter used with AF4554M Filter used with 71686A, AH19073, AH19074 3830497 Bolt Seal Included</p>  <p>Overall Height: 20.68 (525) End 1 OD: 14.60 (371) End 2 OD: 13.83 (351) End 1 ID: 0.90 (23) End 2 ID: 9.48 (241)</p>
<p>AF4532 KOMATSU 6001822500 Safety Element used with AF4533 256017 Bolt Seal Included</p>  <p>Overall Height: 13.52 (343) End 1 OD: 0.65 (17) End 2 OD: 5.09 (129) End 1 ID: 3.81 (97)</p>	<p>AF4545K TOYOTA 177522054071 Same as AF437K with flame retardant paper 3311624 Bolt Seal Included</p>  <p>Overall Height: 11.42 (290) Fin Diameter: 6.34 (161) End 2 OD: 5.24 (133) End 1 ID: 2.71 (69) End 2 ID: 0.67 (17)</p>	<p>AF4554M ONAN 1404655 Safety Element used with AF4553M Filter used with AH19074 3830497 Bolt Seal Included</p>  <p>Overall Height: 18.50 (470) End 1 OD: 0.90 (23) End 2 OD: 8.63 (219) End 1 ID: 7.11 (181)</p>
<p>AF4533 KOMATSU 6001811320 Primary Air Filter used with AF4532</p>  <p>Overall Height: 15.57 (395) Overall OD: 9.65 (245) End 1 ID: 5.25 (133)</p>	<p>AF4547 COOPERS AZA484T</p>  <p>Overall Height: 4.53 (115) Overall OD: 11.93 (303) End 1 ID: 8.50 (216)</p>	<p>AF4555M CHRYSLER 4428308</p>  <p>Overall Height: 9.76 (248) Overall OD: 7.98 (203) End 1 ID: 4.64 (118) End 2 ID: 0.38 (10)</p>

E. PRODUCT GUIDE

AF4557K

CASE E43790 Primary Air Filter used with AF4511

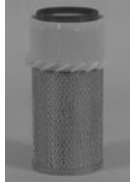

Overall Height: 11.43 (290)
 Fin Diameter: 6.34 (161)
 End 2 OD: 5.24 (133)
 End 1 ID: 2.95 (75)
 End 2 ID: 0.67 (17)

AF4566

RENAULT V.I. 7701027437 Safety Element used with AF4565

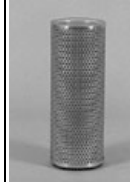

Overall Height: 13.54 (344)
 Overall OD: 5.20 (132)
 End 1 ID: 4.06 (103)
 End 2 ID: 0.34 (9)

AF4575

MERCEDES-BENZ 20947304



Overall Height: 10.07 (256)
 Overall OD: 7.78 (198)
 End 1 ID: 4.08 (104)
 End 2 ID: 0.34 (9)

AF4558

VOLVO 16606004 Safety Element used with AF4559, AF25294



Overall Height: 19.89 (505)
 End 1 OD: 6.12 (156)
 End 2 OD: 6.08 (155)
 End 1 ID: 0.41 (10)
 End 2 ID: 4.91 (125)

AF4567

HITACHI 4129907 Primary Air Filter used with AF490M single element



Overall Height: 15.32 (389)
 Cover Diameter: 9.29 (236)
 End 2 OD: 7.38 (188)
 End 1 ID: 0.67 (17)
 End 2 ID: 4.74 (121)

AF4576M

DONALDSON P521055, FREIGHTLINER FLC112 3830497 Bolt Seal Included



Overall Height: 16.50 (419)
 Overall OD: 12.08 (307)
 End 1 ID: 7.73 (196)
 End 2 ID: 0.90 (23)

AF4559

VOLVO 16606006 Primary Air Filter used with AF4558

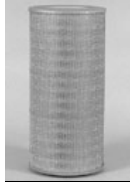

Overall Height: 21.41 (544)
 End 1 OD: 10.16 (258)
 End 2 OD: 10.12 (257)
 End 1 ID: 0.41 (10)
 End 2 ID: 6.34 (161)

AF4568

MASSEY-FERGUSON 1806088M91

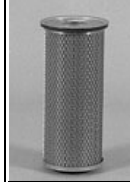

Overall Height: 10.93 (278)
 End 1 OD: 5.04 (128)
 End 2 OD: 4.48 (114)
 End 2 ID: 2.24 (57)

AF4577M

DONALDSON P900556 3830497 Bolt Seal Included



Overall Height: 23.52 (597)
 Overall OD: 12.08 (307)
 End 1 ID: 7.73 (196)
 End 2 ID: 0.90 (23)

AF4560

VOLVO 1544449 Primary Air Filter used with AF4746

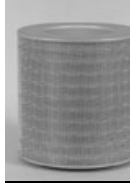

Overall Height: 14.43 (366)
 End 1 OD: 13.78 (350)
 End 2 OD: 13.74 (349)
 End 1 ID: 0.41 (10)
 End 2 ID: 8.31 (211)

AF4569

MASSEY-FERGUSON 1678308M91 Primary Air Filter used with AF4500



Overall Height: 12.64 (321)
 End 1 OD: 5.43 (138)
 End 2 OD: 5.20 (132)
 End 1 ID: 0.37 (10)
 End 2 ID: 2.97 (76)

AF4578

IHC 117210C1



Overall Height: 1.81 (46)
 Overall OD: 7.00 (178)
 End 1 ID: 5.57 (141)

AF4562M

DONALDSON P150693 For element w/o attached cover use AF1850



Overall Height: 28.40 (721)
 Cover Diameter: 9.72 (247)
 End 2 OD: 8.66 (220)
 End 2 ID: 5.21 (132)

AF4570K

J.C.B. 32206002 Primary Air Filter used with AF4571



Overall Height: 13.92 (354)
 Cover Diameter: 7.05 (179)
 Fin Diameter: 6.34 (161)
 End 2 ID: 2.82 (72)
 Thread Size: M10 X 1.5-6H INT

AF4579

CATERPILLAR 8N5006, CASE 530778C1 3311624 Bolt Seal Included



Overall Height: 9.78 (248)
 End 1 OD: 5.97 (152)
 End 2 OD: 0.65 (17)
 End 1 ID: 4.83 (123)

AF4563M

FORD E7HZ9601A



Overall Height: 23.52 (597)
 End 1 OD: 7.35 (187)
 End 2 OD: 7.32 (186)
 End 1 ID: 0.41 (10)
 End 2 ID: 5.40 (137)

AF4571

J.C.B. 32206003 Safety Element used with AF4570K

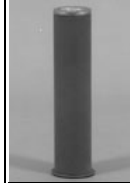

Overall Height: 12.07 (307)
 End 1 OD: 3.27 (83)
 End 2 OD: 2.72 (69)
 End 1 ID: 2.40 (61)
 End 2 ID: 0.67 (17)

AF4580

ALLIS-CHALMERS 246580



Height: 2.19 (56)
 Length: 11.00 (279)
 Width: 10.94 (278)

AF4564KM

JOHN DEERE AL30394 Primary Air Filter used with AF4626 . 3830160 Wing Nut Included; 3311624 Bolt Seal Included



Overall Height: 14.70 (373)
 Cover Diameter: 8.44 (214)
 Fin Diameter: 7.80 (198)
 End 1 ID: 0.67 (17)
 End 2 ID: 3.48 (88)

AF4573K

NISSAN 1654651760

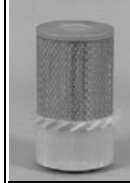

Overall Height: 9.43 (240)
 Fin Diameter: 6.34 (161)
 End 2 OD: 5.24 (133)
 End 1 ID: 2.95 (75)
 End 2 ID: 0.67 (17)

AF4581

VOLVO 842280

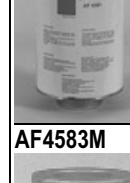

Overall Height: 12.40 (315)
 Overall OD: 7.72 (196)
 End 1 ID: 3.98 (101)

AF4565

RENAULT V.I. 7701027436 Primary Air Filter used with AF4566



Overall Height: 14.53 (369)
 End 1 OD: 8.98 (228)
 End 2 OD: 8.31 (211)
 End 1 ID: 0.39 (10)
 End 2 ID: 5.34 (136)

AF4574

BRIGGS & STRATTON 393957

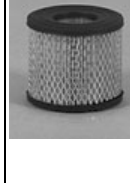

Overall Height: 3.81 (97)
 Overall OD: 4.28 (109)
 End 1 ID: 1.96 (50)











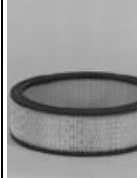
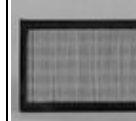

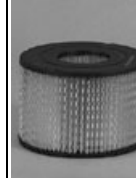





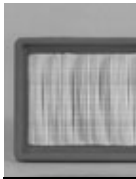
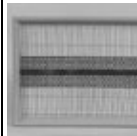

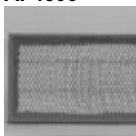
AF4583M

DONALDSON XLP772523, ROLLS ROYCE CV9686 Primary Air Filter used with AF820M





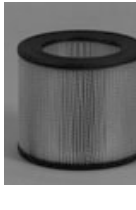







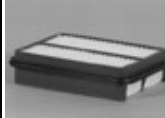
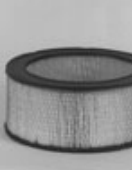
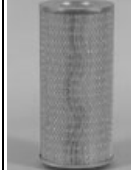







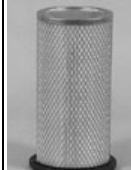

Overall Height: 16.68 (424)
 End 1 OD: 12.08 (307)
 End 2 OD: 12.02 (305)
 End 1 ID: 7.73 (196)
 End 2 ID: 0.67 (17)



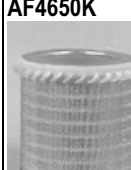







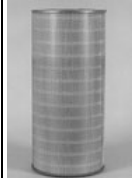

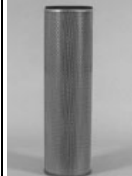





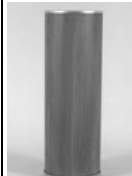
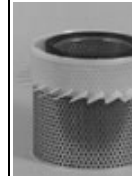

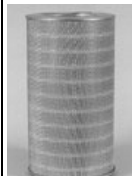
E. PRODUCT GUIDE

AF4586  COOPERS AZA413T Overall Height: 19.61 (498) End 1 OD: 11.50 (292) End 2 OD: 10.39 (264) End 1 ID: 6.54 (166) End 2 ID: 0.67 (17)	AF4604  GMC 5646510 Overall Height: 3.01 (76) Overall OD: 9.50 (241) End 1 ID: 8.00 (203)	AF4615  NISSAN 16546V0100 Height: 1.24 (32) Length: 10.88 (276) Width: 6.55 (166)
AF4587  MERCEDES-BENZ 10947404 Overall Height: 9.06 (230) Cover Diameter: 14.96 (380) End 2 OD: 11.88 (302) End 1 ID: 0.41 (11) End 2 ID: 6.58 (167)	AF4605M  CATERPILLAR 4W5228 Primary Air Filter used with AF1604 Overall Height: 24.60 (625) End 1 OD: 15.70 (399) End 2 OD: 14.69 (373) End 1 ID: 0.88 (22) End 2 ID: 10.30 (262)	AF4616  TOYOTA 1780154010 Overall Height: 4.94 (125) Overall OD: 7.31 (186) End 1 ID: 3.00 (76)
AF4588M  DONALDSON P522293 Gasket: 3831817 Overall Height: 28.90 (734) End 1 OD: 10.40 (264) End 2 OD: 7.49 (190) End 1 ID: 6.95 (177) End 2 ID: 5.45 (138)	AF4606M  CATERPILLAR 4W5716 Primary Air Filter used with AF883M Overall Height: 18.57 (472) End 1 OD: 14.90 (378) End 2 OD: 13.83 (351) End 1 ID: 0.90 (23) End 2 ID: 9.48 (241)	AF4619  FORD E5TE9601AB Height: 1.84 (47) Length: 11.27 (286) Width: 7.57 (192)
AF4589  JOHN DEERE T46317 Safety Element used with AF4893M, AF4894KM, AF4905M, AF434KM. 3834340 Wing Nut Included; 3311624 Bolt Seal Included Overall Height: 15.37 (391) Overall OD: 4.61 (117) End 1 ID: 3.56 (90)	AF4607  TOYOTA 1780148011 Overall Height: 5.75 (146) Overall OD: 7.60 (193) End 1 ID: 3.35 (85)	AF4621  MAZDA 859923603 Overall Height: 4.38 (111) Overall OD: 7.38 (187) End 1 ID: 4.88 (124)
AF4592  GMC 25095333 Height: 1.64 (42) Length: 7.61 (193) Width: 6.00 (152)	AF4608  VOLVO 4771477 Height: 1.50 (38) Length: 7.40 (188) Width: 10.51 (267)	AF4623  HONDA 17220PC6660 Rectangular Shaped Overall Height: 2.73 (69) End 1 ID: 2.90 (74)
AF4593  MOTORCRAFT FA1043 Height: 1.15 (29) Length: 11.24 (286) Width: 6.18 (157)	AF4609  CATERPILLAR 8N6309 Uses service part: AF26169 Overall Height: 10.34 (263) Overall OD: 19.35 (492) End 1 ID: 12.93 (329)	AF4624  FORD E7TE9601AC Height: 1.70 (43) Length: 12.96 (329) Width: 5.94 (151)
AF4594  HONDA 17232PD2660 Overall Height: 2.54 (65) Overall OD: 10.00 (254) End 1 ID: 8.50 (216)	AF4610  FIAT-ALLIS 74835378 Overall Height: 3.80 (97) Largest OD: 3.70 (94) Thread Size: 3/4-14 NPSI	AF4626  JOHN DEERE AL30395 Safety Element used with AF4564KM Overall Height: 13.06 (332) End 1 OD: 3.75 (95) End 2 OD: 3.34 (85) End 1 ID: 2.98 (76) End 2 ID: 0.66 (17)
AF4597  CHRYSLER 4241042, CHRYSLER 4342800 Height: 1.65 (42) Length: 10.68 (271) Width: 5.26 (134)	AF4611K  DONALDSON P900509 Part available in Australia only 3302302 Bolt Seal Included Overall Height: 14.56 (370) End 1 OD: 15.50 (394) End 2 OD: 13.83 (351) End 1 ID: 9.48 (241) End 2 ID: 0.67 (17)	AF4627KM  CASE 3244397R1 3311624 Bolt Seal Included Overall Height: 15.52 (394) Fin Diameter: 10.70 (272) End 2 OD: 7.93 (201) End 1 ID: 5.33 (135) End 2 ID: 0.67 (17)
AF4602  GMC 25043119 Overall Height: 4.93 (125) Overall OD: 5.64 (143) End 1 ID: 3.57 (91) End 2 ID: 3.57 (91)	AF4613  FORD E6SE9601BA Height: 1.55 (39) Length: 11.22 (285) Width: 8.90 (226)	AF4628M  CASE A45694 Primary Air Filter used with AF937 3834340 Wing Nut Included Overall Height: 18.59 (472) End 1 OD: 11.40 (290) End 2 OD: 10.40 (290) End 1 ID: .68 (17) End 2 ID: 6.05 (154)











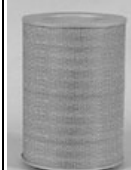

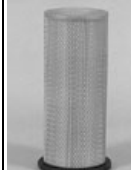
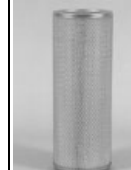







E. PRODUCT GUIDE

<p>AF4631 SCANIA 365729</p>  <p>Overall Height: 18.72 (476) Cover Diameter: 14.96 (380) End 2 OD: 11.88 (302) End 1 ID: 0.41 (11) End 2 ID: 7.55 (192)</p>	<p>AF4642M CASE K200379 Primary Air Filter used with AF4721 3311624 Bolt Seal Included</p>  <p>Overall Height: 11.53 (293) End 1 OD: 5.26 (134) End 2 OD: 5.24 (133) End 1 ID: 3.25 (83) End 2 ID: 0.67 (17)</p>	<p>AF4652 TOYOTA 1780174010</p>  <p>Height: 1.66 (42) Length: 8.80 (224) Width: 6.58 (167)</p>
<p>AF4633 FORD HOUSINGS E7TZ9600A</p>  <p>Overall Height: 5.00 (127) Overall OD: 11.56 (294) End 1 ID: 8.28 (210)</p>	<p>AF4643 LIEBHERR 7401179 Primary Air Filter used with AF4150 3311624 Bolt Seal Included</p>  <p>Overall Height: 16.48 (418) Overall OD: 7.63 (194) End 1 ID: 4.28 (109) End 2 ID: 0.67 (17)</p>	<p>AF4654 MASSEY-FERGUSON 3310355M91, DONALDSON P770181 Safety Element used with AF4891M, AF4655KM, AF25958K</p>  <p>Overall Height: 10.06 (256) End 1 OD: 3.62 (92) End 2 OD: 2.72 (69) End 1 ID: 2.42 (62) End 2 ID: 0.67 (17)</p>
<p>AF4634 CLARK 965169</p>  <p>Height: 2.63 (67) Length: 17.94 (456) Width: 7.94 (202)</p>	<p>AF4644 VOLVO 1544298 Safety Element used with AF4720 For Outer Air use AF4720 on Volvo application</p>  <p>Overall Height: 12.58 (320) Overall OD: 7.76 (197) End 1 ID: 6.93 (176) End 2 ID: 0.41 (11)</p>	<p>AF4655KM MASSEY-FERGUSON 3310358M1 Primary Air Filter used with AF4654 Wing Nut Included</p>  <p>Overall Height: 11.97 (304) Cover Diameter: 7.24 (184) Fin Diameter: 6.42 (163) End 2 ID: 2.84 (72) Thread Size: 7/16-20 UNF-2B</p>
<p>AF4636 CASE A47145 Primary Air Filter used with AF905</p>  <p>Overall Height: 12.50 (318) Overall OD: 10.40 (264) End 1 ID: 6.05 (154) End 2 ID: 0.90 (23)</p>	<p>AF4645 RENAULT V.I. 5000809894</p>  <p>Overall Height: 11.73 (298) Cover Diameter: 10.20 (259) End 2 OD: 9.13 (232) End 2 ID: 4.57 (116)</p>	<p>AF4656 PUROLATOR AF1624</p>  <p>Overall Height: 24.00 (610) Overall OD: 16.64 (423) End 1 ID: 11.99 (305)</p>
<p>AF4637 MANN & HUMMEL C17160 Primary Air Filter used with AF25424</p>  <p>Overall Height: 8.36 (212) Overall OD: 6.44 (164) End 1 ID: 3.40 (86)</p>	<p>AF4646M DONALDSON P900405 Safety Element used with AF4647KM 3311624 Bolt Seal Included</p>  <p>Overall Height: 13.06 (332) End 1 OD: 0.67 (17) End 2 OD: 6.41 (163) End 1 ID: 5.27 (134)</p>	<p>AF4657 RENAULT V.I. 5000814797 Primary Air Filter used with AF4658</p>  <p>Overall Height: 15.34 (390) End 1 OD: 12.08 (307) End 2 OD: 12.02 (305) End 1 ID: 7.73 (196) End 2 ID: 0.67 (17)</p>
<p>AF4638 VOLVO 6792554</p>  <p>Overall Height: 23.29 (592) Cover Diameter: 8.15 (207) End 2 OD: 7.36 (187) End 1 ID: 0.41 (10) End 2 ID: 4.57 (116)</p>	<p>AF4647KM DONALDSON P900408 Primary Air Filter used with AF4646M 3830497 Seal Included</p>  <p>Overall Height: 13.56 (344) Fin Diameter: 13.80 (351) End 2 OD: 11.08 (281) End 1 ID: 0.90 (23) End 2 ID: 6.73 (171)</p>	<p>AF4658 RENAULT V.I. 5000814798 Safety Element used with AF4657, AF25801</p>  <p>Overall Height: 14.44 (367) End 1 OD: 8.43 (214) End 2 OD: 7.31 (186) End 1 ID: 6.23 (158) End 2 ID: 0.67 (17)</p>
<p>AF4639 CATERPILLAR 8N4901 Safety Element used with AF344M</p>  <p>Overall Height: 12.00 (305) Flange Diameter: 7.30 (185) End 2 OD: 4.78 (121) End 1 ID: 3.59 (91)</p>	<p>AF4650K DONALDSON P900690 Primary Air Filter used with AF4651 3302302 Bolt Seal Included</p>  <p>Overall Height: 14.62 (371) Fin Diameter: 15.50 (394) End 2 OD: 13.80 (351) End 1 ID: 0.67 (17) End 2 ID: 9.48 (241)</p>	<p>AF4660 COOPERS AZA353T Safety Element used with AF435KM</p>  <p>Overall Height: 9.04 (230) End 1 OD: 2.76 (70) End 2 OD: 2.40 (61) End 1 ID: 2.01 (51) End 2 ID: 0.67 (17)</p>
<p>AF4641M VOLVO 1660375</p>  <p>Overall Height: 22.73 (577) End 1 OD: 10.63 (270) End 2 OD: 10.59 (269) End 1 ID: 0.41 (10) End 2 ID: 6.22 (158)</p>	<p>AF4651 DONALDSON P900691 Safety Element used with AF4650K 3311624 Bolt Seal Included</p>  <p>Overall Height: 13.44 (341) Overall OD: 8.26 (210) End 1 ID: 7.10 (180) End 2 ID: 0.67 (17)</p>	<p>AF4662 RENAULT V.I. 5000814944</p>  <p>Overall Height: 15.46 (393) Cover Diameter: 14.33 (364) End 2 OD: 9.92 (252) End 1 ID: 0.63 (16) End 2 ID: 6.50 (165)</p>



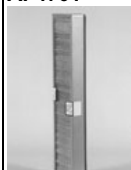
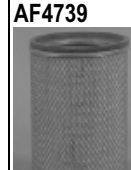







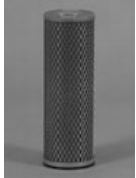

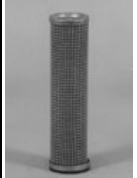

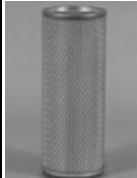

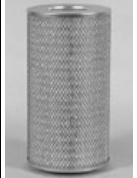
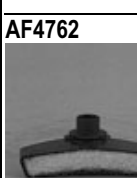

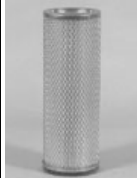

E. PRODUCT GUIDE

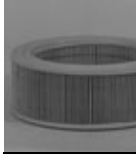
AF4663  FENDT F198810140010 Height: 2.17 (55) Length: 23.70 (602) Width: 4.33 (110)	AF4674  AIR MAZE CD1628610826 Primary Air Filter used with AF4675 Filter used with AH19324 Overall Height: 27.06 (687) Overall OD: 12.56 (319) End 1 ID: 7.50 (191) End 2 ID: 0.40 (10)	AF4695  ISUZU 5142150300 Overall Height: 10.75 (273) Overall OD: 6.08 (154) End 1 ID: 3.48 (88) End 2 ID: 0.56 (14)
AF4664  DONALDSON P521598 Uses service part: 3301159S Overall Height: 25.00 (635) End 1 OD: 11.82 (300) End 2 OD: 9.80 (249) End 1 ID: 7.36 (187)	AF4675  AIR MAZE CD1628610827 Safety Element used with AF4674 Filter used with AH19324 Overall Height: 25.38 (645) Overall OD: 7.38 (187) End 1 ID: 6.12 (155) End 2 ID: 0.64 (16)	AF4696  ISUZU 8941042730 Overall Height: 7.82 (199) Overall OD: 6.08 (154) End 1 ID: 3.48 (88) End 2 ID: 0.56 (14)
AF4666  AIR MAZE CD0510610826 Overall Height: 9.09 (231) Overall OD: 5.53 (140) End 1 ID: 3.06 (78)	AF4676  AIR MAZE CD1830610826 Primary Air Filter used with AF4677 Overall Height: 29.50 (749) Overall OD: 13.90 (353) End 1 ID: 9.95 (253)	AF4699  ISUZU 1142151180 Overall Height: 18.34 (466) Overall OD: 7.29 (185) End 1 ID: 6.18 (157) End 2 ID: 0.75 (19)
AF4668  AIR MAZE CD1017610826 Primary Air Filter used with AF963 Filter used with AH1147 Overall Height: 15.40 (391) Overall OD: 8.53 (217) End 1 ID: 0.42 (11) End 2 ID: 5.39 (137)	AF4677  AIR MAZE CD1830610827 Safety Element used with AF4676 Overall Height: 28.28 (718) End 1 OD: 0.54 (14) End 2 OD: 9.88 (251) End 1 ID: 8.05 (204)	AF4700K  MITSUBISHI MB120298 . Wing Nut Included Overall Height: 7.38 (187) Fin Diameter: 10.00 (254) End 2 OD: 8.66 (220) End 1 ID: 4.94 (125) End 2 ID: 0.32 (8)
AF4669  AIR MAZE CD1219610826 Primary Air Filter used with AF4670 Filter used with AH1174 Overall Height: 17.50 (445) Overall OD: 10.00 (254) End 1 ID: 5.88 (149)	AF4678  AIR MAZE CD1623610826 Primary Air Filter used with AF25218 Filter used with AH1151 Overall Height: 22.24 (565) Overall OD: 12.56 (319) End 1 ID: 7.50 (191) End 2 ID: 0.40 (10)	AF4701  HINO 178011960 Overall Height: 9.69 (246) Overall OD: 7.87 (200) End 1 ID: 3.90 (99) End 2 ID: 0.59 (15)
AF4670  AIR MAZE CD1219610830 Safety Element used with AF4669 Filter used with AH1174 Overall Height: 15.98 (406) Overall OD: 5.71 (145) End 1 ID: 5.00 (127) End 2 ID: 0.64 (16)	AF4691  MERCEDES-BENZ 20947004 Overall Height: 11.91 (303) Overall OD: 5.87 (149) End 1 ID: 2.80 (71) End 2 ID: 0.41 (11)	AF4705  HINO 178012200 Overall Height: 12.75 (324) Overall OD: 8.50 (216) End 1 ID: 5.39 (137) End 2 ID: 0.88 (22)
AF4671  AIR MAZE CD1417610826 Primary Air Filter used with AF4672 Overall Height: 15.44 (392) Overall OD: 11.47 (291) End 1 ID: 7.00 (178) End 2 ID: 0.38 (10)	AF4692  CATERPILLAR 7W9853 Primary Air Filter used with AF4694 Gasket: 3309167 (1) Overall Height: 18.56 (472) Overall OD: 14.26 (362) End 2 ID: 9.89 (251)	AF4706  MITSUBISHI ME033603 Overall Height: 18.00 (457) Flange Diameter: 10.35 (263) End 2 OD: 8.70 (221) End 1 ID: 0.94 (24) End 2 ID: 5.35 (136)
AF4672  AIR MAZE CD1417610827 Safety Element used with AF4671 Overall Height: 13.94 (354) Overall OD: 6.88 (175) End 1 ID: 5.42 (138)	AF4694  CATERPILLAR 7W9567 Safety Element used with AF4692 Overall Height: 18.13 (460) End 1 OD: 12.10 (307) End 2 OD: 9.81 (249) End 1 ID: 8.13 (206)	AF4709  ISUZU 8941017690 Overall Height: 9.75 (248) Overall OD: 6.08 (154) End 1 ID: 3.48 (88) End 2 ID: 0.56 (14)





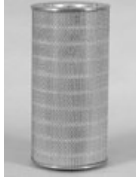







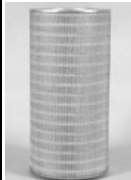
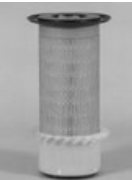
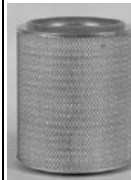
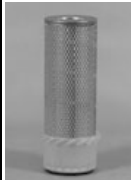

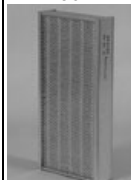

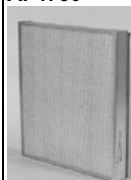
E. PRODUCT GUIDE

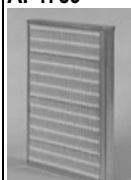
AF4711  ISUZU 1142151160 Overall Height: 19.87 (505) Overall OD: 12.06 (306) End 1 ID: 2.38 (60)	AF4725  SCANIA 395776 Primary Air Filter used with AF4726 Overall Height: 17.19 (437) Overall OD: 12.08 (307) End 1 ID: 7.73 (196) End 2 ID: 0.67 (17)	AF4733  ISUZU 8941560520 250806 Bolt Seal Included Overall Height: 10.57 (268) Overall OD: 7.93 (201) End 1 ID: 5.33 (135) End 2 ID: 0.87 (22)
AF4713  MANN & HUMMEL C301537 Primary Air Filter used with AF4898 Seal included Overall Height: 18.72 (476) End 1 OD: 11.88 (302) End 2 OD: 11.84 (301) End 1 ID: 7.55 (192) End 2 ID: 0.41 (11)	AF4726  SCANIA 397814 Safety Element used with AF4725 Overall Height: 15.72 (399) End 1 OD: 7.59 (193) End 2 OD: 6.40 (163) End 1 ID: 5.28 (134) End 2 ID: 0.67 (17)	AF4734  STEIGER 904204T1 Safety Element used with AF4729 3311624 Bolt Seal Included Overall Height: 20.38 (518) End 1 OD: 0.68 (17) End 2 OD: 7.65 (194) End 1 ID: 6.02 (153)
AF4714  VOLVO 1661667, CHAMP LAF4271, LUBERFINER LAF4271 Primary Air Filter used with AF4719 Overall Height: 26.23 (666) Cover Diameter: 13.33 (339) End 2 OD: 10.98 (279) End 2 ID: 7.24 (184)	AF4727  SCANIA 397813 Safety Element used with AF25066, AF25045M Overall Height: 14.82 (377) End 1 OD: 6.38 (162) End 2 OD: 6.10 (155) End 1 ID: 5.75 (146) End 2 ID: 0.67 (17)	AF4735  DONALDSON P150703 Overall Height: 13.48 (342) End 1 OD: 13.85 (352) End 1 ID: 7.44 (189)
AF4719  VOLVO 1661668 Safety Element used with AF4714 Seal included Overall Height: 25.37 (645) Overall OD: 6.97 (177) End 1 ID: 5.30 (135) End 2 ID: 0.41 (10)	AF4728  EUCLID 9029495 Overall Height: 4.81 (122) Overall OD: 4.25 (108) End 1 ID: 1.56 (40)	AF4736  JOHN DEERE AT65296 Primary Air Filter used with AF1980 3311624 Bolt Seal Included Overall Height: 12.48 (317) End 1 OD: 6.85 (174) End 2 OD: 6.83 (174) End 1 ID: 0.67 (17) End 2 ID: 3.48 (88)
AF4720  VOLVO 1660619 Primary Air Filter used with AF4644 . 250806 Bolt Seal Included Overall Height: 14.50 (368) End 1 OD: 12.22 (311) End 2 OD: 12.19 (310) End 1 ID: 0.41 (10) End 2 ID: 7.89 (201)	AF4729  STEIGER 904203S1 Primary Air Filter used with AF4734 3830497 Bolt Seal Included Overall Height: 21.50 (546) Overall OD: 12.08 (307) End 1 ID: 7.73 (196) End 2 ID: 0.90 (23)	AF4737  SCANIA 370750 Overall Height: 20.38 (518) Cover Diameter: 12.17 (309) End 2 OD: 9.54 (242) End 1 ID: 0.41 (11) End 2 ID: 5.21 (132)
AF4721  CASE K200380 Safety Element used with AF4642M Overall Height: 9.94 (252) End 1 OD: 2.97 (75) End 2 OD: 2.88 (73) End 1 ID: 0.44 (11) End 2 ID: 1.86 (47)	AF4730  CASE 935693C1 3311624 Bolt Seal Included Overall Height: 14.35 (364) End 1 OD: 0.65 (17) End 2 OD: 5.97 (152) End 1 ID: 4.83 (123) End 2 ID: 5.96 (151)	AF4738  MACK 57MD44M Overall Height: 28.38 (721) End 1 OD: 8.85 (225) End 2 OD: 8.83 (224) End 2 ID: 5.82 (148)
AF4723  METROPLEX M00709102 Overall Height: 21.07 (535) Overall OD: 12.08 (307) End 1 ID: 7.73 (196)	AF4731  CATERPILLAR 7T1890 Height: 2.69 (68) Length: 26.18 (665) Width: 5.35 (136)	AF4739  ISUZU 8944302500 3830497 Bolt Seal Included Overall Height: 13.50 (343) End 1 OD: 10.45 (265) End 2 OD: 8.70 (221) End 1 ID: 9.00 (229) End 2 ID: 5.33 (135)
AF4724  VOLVO 6778729 250806 Bolt Seal Included Overall Height: 22.53 (572) Overall OD: 7.89 (200) End 1 ID: 4.52 (115) End 2 ID: 0.45 (11)	AF4732  CASE F64318 Height: 2.19 (56) Length: 38.00 (965) Width: 7.00 (178)	AF4743K  KOMATSU 6001817260 Primary Air Filter used with AF4744 Overall Height: 11.42 (290) Fin Diameter: 6.34 (161) End 2 OD: 5.24 (133) End 1 ID: 3.35 (85) Thread Size: M10 X 1.5-6H INT

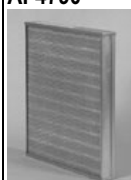

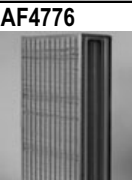
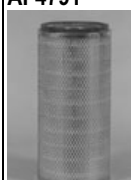

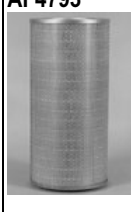





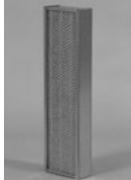
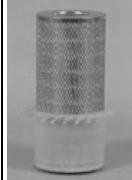



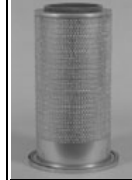

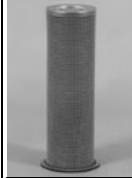
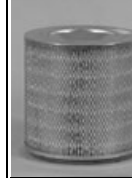
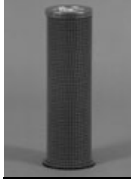
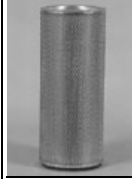
E. PRODUCT GUIDE

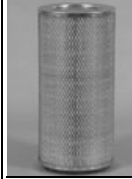
<p>AF4744</p>  <p>Safety Element used with AF4743K, AF25432K Seal included.</p> <p>Overall Height: 9.57 (243) Overall OD: 3.27 (83) End 1 ID: 2.13 (54) End 2 ID: 0.65 (17)</p>	<p>AF4752</p>  <p>AIR MAZE CD1222610830 Safety Element used with AF4751</p> <p>Overall Height: 18.50 (470) Overall OD: 5.68 (144) End 1 ID: 4.94 (125)</p>	<p>AF4760</p>  <p>DONALDSON R804518</p> <p>Overall Height: 9.15 (232) Overall OD: 2.46 (62) End 1 ID: 1.94 (49) End 2 ID: 0.66 (17)</p>
<p>AF4745</p>  <p>KHD(KLOCKNER-HUMBOLDT-DEUTZ) 2379163 Safety Element used with AF991</p> <p>Overall Height: 12.87 (327) End 1 OD: 3.54 (90) End 2 OD: 3.31 (84) End 1 ID: 2.99 (76) End 2 ID: 0.43 (11)</p>	<p>AF4753M</p>  <p>LIEBHERR 7403953 Primary Air Filter used with AF4761M . 3834340 Wing Nut Included; 3311624 Bolt Seal Included</p> <p>Overall Height: 16.55 (420) End 1 OD: 12.50 (318) End 2 OD: 10.40 (264) End 1 ID: 0.66 (17) End 2 ID: 6.05 (154)</p>	<p>AF4761M</p>  <p>LIEBHERR 7403951, FRAM CA8859SY Safety Element used with AF4753M, AF4980KM, AF4981M, AF25315K . 3311624 Bolt Seal Included</p> <p>Overall Height: 15.37 (391) End 1 OD: 5.97 (152) End 2 OD: 5.96 (151) End 1 ID: 0.67 (17) End 2 ID: 4.85 (123)</p>
<p>AF4746</p>  <p>VOLVO 1660903 Safety Element used with AF4560</p> <p>Overall Height: 12.60 (320) Overall OD: 7.76 (197) End 1 ID: 6.54 (166) End 2 ID: 0.39 (10)</p>	<p>AF4754</p>  <p>STEIGER 906443T1 Primary Air Filter used with AF4755 Filter used with AH19272</p> <p>Overall Height: 17.54 (445) End 1 OD: 9.21 (234) End 2 OD: 9.14 (232) End 1 ID: 0.67 (17) End 2 ID: 5.87 (149)</p>	<p>AF4762</p>  <p>FORD D7EF9D695AA</p> <p>Height: 1.25 (32) Overall OD: 0.55 (14) Length: 3.21 (82) Width: 1.43 (36)</p>
<p>AF4747</p>  <p>IVECO 107030, IVECO 107029 Primary Air Filter used with AF4970 Seal included.</p> <p>Overall Height: 20.52 (521) End 1 OD: 12.08 (307) End 2 OD: 12.02 (305) End 1 ID: 7.73 (196) End 2 ID: 0.67 (17)</p>	<p>AF4755</p>  <p>STEIGER 906444T1 Safety Element used with AF4754 3311624 Bolt Seal Included</p> <p>Overall Height: 15.61 (396) End 1 OD: 0.65 (17) End 2 OD: 5.56 (141) End 1 ID: 4.41 (112)</p>	<p>AF4763</p>  <p>TOYOTA 178022300071 Flame Retardant Media</p> <p>Overall Height: 11.04 (281) End 1 OD: 5.23 (133) End 2 OD: 5.21 (132) End 1 ID: 0.51 (13) End 2 ID: 2.56 (65)</p>
<p>AF4748K</p>  <p>POCLAIN TI950555 Primary Air Filter used with AF4103 Wing Nut Included</p> <p>Overall Height: 15.48 (393) Cover Diameter: 8.37 (213) Fin Diameter: 7.85 (200) End 2 ID: 3.48 (89) Thread Size: 7/16-20 UNF-2B</p>	<p>AF4756</p>  <p>CASE A171255 Primary Air Filter used with AF4757 3311624 Bolt Seal Included</p> <p>Overall Height: 16.55 (420) End 1 OD: 9.90 (251) End 2 OD: 9.88 (251) End 1 ID: 0.67 (17) End 2 ID: 6.07 (154)</p>	<p>AF4764</p>  <p>TOYOTA 178012300071</p> <p>Overall Height: 11.04 (281) End 1 OD: 5.27 (134) End 2 OD: 5.21 (132) End 1 ID: 0.51 (13) End 2 ID: 2.56 (65)</p>
<p>AF4749</p>  <p>FORD 87HX9601AA</p> <p>Overall Height: 3.74 (95) Overall OD: 9.57 (243) End 1 ID: 7.24 (184)</p>	<p>AF4757</p>  <p>CASE A171256 Safety Element used with AF4756</p> <p>Overall Height: 14.50 (368) End 1 OD: 0.65 (17) End 2 OD: 5.97 (152) End 1 ID: 4.83 (123) End 2 ID: 5.96 (151)</p>	<p>AF4765</p>  <p>FORD E7TE9D695BA</p> <p>Height: 2.42 (61) Length: 4.39 (112) Width: 1.26 (32)</p>
<p>AF4750</p>  <p>QUINCY 234583 Quincy Compressor 250806. Bolt Seal Included</p> <p>Overall Height: 21.25 (540) Overall OD: 12.56 (319) End 1 ID: 7.50 (191) End 2 ID: 0.40 (10)</p>	<p>AF4758KM</p>  <p>KOMATSU 3EA0118130 3311624 Bolt Seal Included</p> <p>Overall Height: 10.56 (268) Cover Diameter: 5.91 (150) End 2 OD: 5.16 (131) End 1 ID: 0.67 (17) End 2 ID: 2.56 (65)</p>	<p>AF4767</p>  <p>FRANKLIN 1504917 Primary Air Filter used with AF25542</p> <p>Overall Height: 13.58 (345) End 1 OD: 9.62 (244) End 2 OD: 9.01 (229) End 2 ID: 5.71 (145)</p>
<p>AF4751</p>  <p>AIR MAZE CD1222610826 Primary Air Filter used with AF4752</p> <p>Overall Height: 20.00 (508) Overall OD: 10.00 (254) End 1 ID: 0.39 (10) End 2 ID: 5.88 (149)</p>	<p>AF4759M</p>  <p>DONALDSON P150706 3311624 Bolt Seal Included</p> <p>Overall Height: 14.50 (368) End 1 OD: 6.85 (174) End 2 OD: 6.83 (174) End 1 ID: 0.67 (17) End 2 ID: 3.48 (88)</p>	<p>AF4768</p>  <p>SULLAIR 250022888</p> <p>Overall Height: 11.43 (290) Overall OD: 6.70 (170) End 1 ID: 3.68 (93) End 2 ID: 0.48 (12)</p>

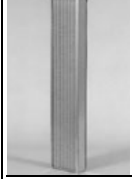





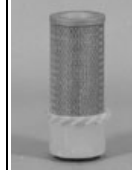





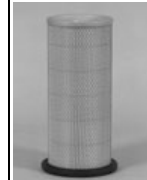











E. PRODUCT GUIDE

<p>AF4769 CATERPILLAR 8N6883 Safety Element used with AF336M Fleetguard Airkit Option AF4526 + AK00012</p>  <p>Overall Height: 16.13 (410) Flange Diameter: 9.06 (230) End 2 OD: 6.28 (160) End 1 ID: 4.59 (117)</p>	<p>AF4783 DONALDSON P151244</p>  <p>Overall Height: 26.50 (673) Overall OD: 12.77 (324) End 1 ID: 8.36 (212)</p>	<p>AF4799 DONALDSON P145891</p>  <p>Overall Height: 26.50 (673) Overall OD: 12.77 (324) End 1 ID: 8.36 (212) End 2 ID: 0.53 (13)</p>
<p>AF4770K LEYLAND ACU7630 Wing Nut Included</p>  <p>Overall Height: 15.54 (395) Cover Diameter: 8.27 (210) Fin Diameter: 7.85 (200) End 2 ID: 3.48 (88)</p>	<p>AF4784 DONALDSON P153972</p>  <p>Overall Height: 17.05 (433) Overall OD: 13.83 (351) End 1 ID: 9.48 (241)</p>	<p>AF4800K DONALDSON P148586 Primary Air Filter used with AF1892</p>  <p>Overall Height: 15.38 (391) Fin Diameter: 6.39 (162) End 2 OD: 5.25 (133) End 1 ID: 3.26 (83) End 2 ID: 0.68 (17)</p>
<p>AF4771 Replacement element for kit to convert CAT 7W9567. Use w/ bracket AK00013. 3311624 Bolt Seal Included</p>  <p>Overall Height: 16.86 (428) End 1 OD: 0.68 (17) End 2 OD: 9.83 (250) End 1 ID: 8.43 (214) End 2 ID: 9.83 (250)</p>	<p>AF4785 DONALDSON P520450</p>  <p>Height: 2.19 (56) Length: 16.00 (406) Width: 8.00 (203)</p>	<p>AF4801 DONALDSON SMP181073 Primary Air Filter used with AF4819</p>  <p>Overall Height: 19.50 (495) Overall OD: 12.08 (307) End 1 ID: 7.73 (196) End 2 ID: 0.90 (23)</p>
<p>AF4772 FORD E7HZ9601B</p>  <p>Overall Height: 16.55 (420) Overall OD: 10.40 (264) End 1 ID: 6.05 (154) End 2 ID: 0.68 (17)</p>	<p>AF4786 DONALDSON P102052</p>  <p>Height: 2.57 (65) Length: 19.50 (495) Width: 19.50 (495)</p>	<p>AF4802K DONALDSON P101038</p>  <p>Overall Height: 12.25 (311) Fin Diameter: 10.06 (256) End 2 OD: 7.93 (201) End 1 ID: 3.57 (91) End 2 ID: 0.53 (13)</p>
<p>AF4773 DONALDSON P113330</p>  <p>Height: 2.19 (56) Length: 24.00 (610) Width: 5.00 (127)</p>	<p>AF4789 DONALDSON P121351</p>  <p>Height: 2.19 (56) Length: 20.00 (508) Width: 15.00 (381)</p>	<p>AF4804 DONALDSON P109531</p>  <p>Overall Height: 4.13 (105) Overall OD: 13.84 (352) End 1 ID: 9.47 (241) End 2 ID: 0.53 (13)</p>
<p>AF4775 IVECO 1901780 Seal included.</p>  <p>Overall Height: 16.37 (416) Overall OD: 12.08 (307) End 1 ID: 7.73 (196) End 2 ID: 0.87 (22)</p>	<p>AF4790 DONALDSON P128409</p>  <p>Height: 2.19 (56) Length: 18.50 (470) Width: 17.00 (432)</p>	<p>AF4805 DONALDSON P110852</p>  <p>Overall Height: 18.50 (470) Overall OD: 11.09 (282) End 1 ID: 6.72 (171) End 2 ID: 0.53 (13)</p>
<p>AF4776 DONALDSON P114101 Vee Pack</p>  <p>Height: 10.84 (275) Length: 35.54 (903) Width: 18.50 (470)</p>	<p>AF4791 DONALDSON P129196</p>  <p>Overall Height: 16.50 (419) Overall OD: 7.93 (201) End 1 ID: 3.57 (91) End 2 ID: 0.53 (13)</p>	<p>AF4806 DONALDSON P112059</p>  <p>Overall Height: 12.38 (314) Overall OD: 6.85 (174) End 1 ID: 4.23 (107) End 2 ID: 0.68 (17)</p>
<p>AF4778 DONALDSON P125744</p>  <p>Overall Height: 22.00 (559) Overall OD: 12.75 (324) End 1 ID: 8.37 (213)</p>	<p>AF4793 DONALDSON P131912</p>  <p>Overall Height: 26.50 (673) Overall OD: 12.75 (324) End 1 ID: 8.38 (213) End 2 ID: 0.53 (13)</p>	<p>AF4807 DONALDSON P112775</p>  <p>Height: 2.19 (56) Length: 38.00 (965) Width: 5.00 (127)</p>

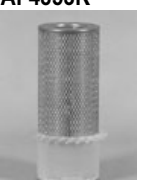





















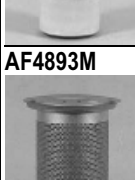

E. PRODUCT GUIDE

<p>AF4809 DONALDSON P115051</p>  <p>Height: 2.19 (56) Length: 18.50 (470) Width: 5.25 (133)</p>	<p>AF4823K DONALDSON P131331</p>  <p>Overall Height: 15.43 (392) Fin Diameter: 8.89 (226) End 2 OD: 6.84 (174) End 1 ID: 3.48 (88) End 2 ID: 0.66 (17)</p>	<p>AF4837 DONALDSON SMP181149</p>  <p>Overall Height: 8.43 (214) Overall OD: 9.22 (234) End 1 ID: 4.84 (123) End 2 ID: 0.66 (17)</p>
<p>AF4810 DONALDSON P117049</p>  <p>Height: 2.19 (56) Length: 47.00 (1194) Width: 7.00 (178)</p>	<p>AF4826K DONALDSON P132935 Primary Air Filter used with AF4827</p>  <p>Overall Height: 14.56 (370) Fin Diameter: 8.88 (226) End 2 OD: 6.85 (174) End 1 ID: 4.23 (108) End 2 ID: 0.67 (17)</p>	<p>AF4838 DONALDSON SMP181191 Primary Air Filter used with AF4896</p>  <p>Overall Height: 17.90 (455) End 1 OD: 10.45 (265) End 2 OD: 8.70 (221) End 1 ID: 0.90 (23) End 2 ID: 5.33 (135)</p>
<p>AF4812 DONALDSON P118785</p>  <p>Overall Height: 8.39 (213) Flange Diameter: 4.54 (115) End 2 OD: 2.38 (60) End 1 ID: 1.91 (49) End 2 ID: 0.41 (10)</p>	<p>AF4827 DONALDSON P132939 Safety Element used with AF4826K</p>  <p>Overall Height: 13.05 (332) Flange Diameter: 4.84 (123) End 2 OD: 4.10 (104) End 1 ID: 3.65 (93) End 2 ID: 0.66 (17)</p>	<p>AF4839 DONALDSON SMP181200</p>  <p>Overall Height: 10.50 (267) Overall OD: 10.41 (264) End 1 ID: 6.03 (153)</p>
<p>AF4813 DONALDSON P119791 Safety Element used with AF409K</p>  <p>Overall Height: 11.52 (293) End 1 OD: 3.74 (95) End 2 OD: 3.36 (85) End 1 ID: 2.93 (74) End 2 ID: 2.26 (57)</p>	<p>AF4828 DONALDSON P133179</p>  <p>Overall Height: 18.38 (467) Overall OD: 7.63 (194) End 1 ID: 6.04 (153) End 2 ID: 0.66 (17)</p>	<p>AF4840 DONALDSON P522451</p>  <p>Overall Height: 13.06 (332) Overall OD: 9.73 (247) End 1 ID: 5.66 (144) End 2 ID: 0.66 (17)</p>
<p>AF4817 JOHN DEERE AT68184 Safety Element used with AF818K</p>  <p>Overall Height: 9.05 (230) Flange Diameter: 3.64 (92) End 2 OD: 2.95 (75) End 1 ID: 2.40 (61) End 2 ID: 0.66 (17)</p>	<p>AF4833 DONALDSON P158852</p>  <p>Overall Height: 16.50 (419) Overall OD: 7.93 (201) End 1 ID: 5.32 (135) End 2 ID: 0.66 (17)</p>	<p>AF4841 RENAULT V.I. 5010064371 Primary Air Filter used with AF4867 Seal included</p>  <p>Overall Height: 15.60 (396) End 1 OD: 12.09 (307) End 2 OD: 12.07 (307) End 1 ID: 7.74 (197) End 2 ID: 0.67 (17)</p>
<p>AF4818 DONALDSON P124767 Safety Element used with AF4835K</p>  <p>Overall Height: 10.05 (255) Flange Diameter: 4.12 (105) End 2 OD: 3.36 (85) End 1 ID: 2.26 (57) End 2 ID: 0.66 (17)</p>	<p>AF4834 DONALDSON P158893</p>  <p>Height: 2.57 (65) Length: 30.00 (762) Width: 6.00 (152)</p>	<p>AF4842 MERCEDES-BENZ 30944204 Seal included.</p>  <p>Overall Height: 10.20 (259) Overall OD: 12.89 (328) End 1 ID: 6.34 (161) End 2 ID: 0.41 (11)</p>
<p>AF4819 DONALDSON P127313 Safety Element used with AF4801</p>  <p>Overall Height: 18.48 (469) End 1 OD: 7.27 (185) End 2 OD: 0.65 (17) End 1 ID: 6.19 (157)</p>	<p>AF4835K DONALDSON SMP181093 Primary Air Filter used with AF4818</p>  <p>Overall Height: 11.50 (292) Fin Diameter: 7.84 (199) End 2 OD: 6.09 (155) End 1 ID: 3.48 (88) End 2 ID: 0.66 (17)</p>	<p>AF4843 CASE L32513 Safety Element used with AF4845K</p>  <p>Overall Height: 9.06 (230) End 1 OD: 5.32 (135) End 2 OD: 6.40 (163) End 1 ID: 5.27 (134)</p>
<p>AF4821 DONALDSON P128252</p>  <p>Overall Height: 14.50 (368) Overall OD: 10.40 (264) End 1 ID: 6.04 (153) End 2 ID: 0.66 (17)</p>	<p>AF4836 DONALDSON SMP181132</p>  <p>Overall Height: 9.50 (241) Overall OD: 0.69 (17) End 1 ID: 4.23 (107) End 2 ID: 0.68 (17)</p>	<p>AF4844KM CLARK 2353816 Flame Retardant Media Seal included.</p>  <p>Overall Height: 10.43 (265) Fin Diameter: 5.16 (131) End 2 OD: 4.08 (104) End 1 ID: 2.56 (65) End 2 ID: 0.67 (17)</p>





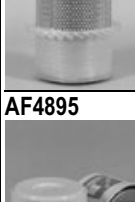







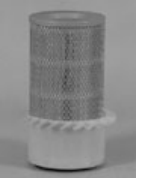
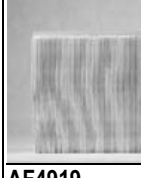

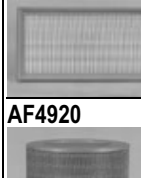

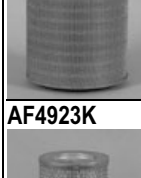



E. PRODUCT GUIDE

AF4845K  CASE L32512 Primary Air Filter used with AF4843 Overall Height: 9.56 (243) Fin Diameter: 13.80 (351) End 2 OD: 11.08 (281) End 1 ID: 0.67 (17) End 2 ID: 6.73 (171)	AF4856M  JOHN DEERE DDX18911 Primary Air Filter used with AF4103 Wing nut included Overall Height: 15.39 (391) Cover Diameter: 8.39 (213) End 2 OD: 6.99 (178) End 2 ID: 3.45 (88) Thread Size: 7/16-20 UNF-2B	AF4867  RENAULT V.I. 5010064372 Safety Element used with AF25249M, AF4841, AF4927, AF25284M Overall Height: 15.00 (381) End 1 OD: 7.31 (186) End 2 OD: 6.40 (163) End 1 ID: 5.28 (134) End 2 ID: 0.67 (17)
AF4846  HINO 178012620 Primary Air Filter used with AF4847 Overall Height: 13.46 (342) End 1 OD: 9.21 (234) End 2 OD: 7.37 (187) End 1 ID: 0.67 (17) End 2 ID: 4.72 (120)	AF4857KM  COOPERS AZA327T Seal included. Overall Height: 16.58 (421) Fin Diameter: 9.96 (253) End 2 OD: 7.93 (201) End 1 ID: 5.33 (135) End 2 ID: 0.67 (17)	AF4868  ISUZU 1142151570 Safety Element used with AF4869 Overall Height: 10.07 (256) End 1 OD: 0.67 (17) End 2 OD: 4.62 (117) End 1 ID: 3.51 (89) End 2 ID: 4.62 (117)
AF4847  HINO 178012610 Safety Element used with AF4846 Overall Height: 12.09 (307) End 1 OD: 0.67 (17) End 2 OD: 4.62 (117) End 1 ID: 3.51 (89)	AF4858KM  CASE K306535 Seal included. Overall Height: 13.55 (344) Fin Diameter: 9.96 (253) End 2 OD: 7.93 (201) End 1 ID: 5.33 (135) End 2 ID: 0.67 (17)	AF4869  ISUZU 1142151560 Primary Air Filter used with AF4868 Overall Height: 11.25 (286) End 1 OD: 9.21 (234) End 2 OD: 7.37 (187) End 1 ID: 0.67 (17) End 2 ID: 4.72 (120)
AF4848  DONALDSON P015839 Overall Height: 15.00 (381) Overall OD: 10.40 (264) End 1 ID: 7.79 (198)	AF4861M  DONALDSON P145328 Overall Height: 29.01 (737) End 1 OD: 8.85 (225) End 2 OD: 8.83 (224) End 2 ID: 5.82 (148)	AF4870M  FORD E8HT9600CB Overall Height: 7.69 (195) Overall OD: 13.85 (352) End 1 ID: 7.44 (189) End 2 ID: 0.67 (17)
AF4850  DONALDSON P120949 Safety Element used with AF435KM Overall Height: 8.44 (214) Flange Diameter: 4.54 (115) End 2 OD: 2.38 (60) End 1 ID: 1.91 (49) End 2 ID: 0.66 (17)	AF4862  TEREX 9054912 Safety Element used with AF935M Overall Height: 18.10 (460) Overall OD: 10.88 (276) End 1 ID: 8.16 (207) End 2 ID: 0.90 (23)	AF4871M  DONALDSON XLP182099 Overall Height: 18.52 (470) End 1 OD: 16.26 (413) End 2 OD: 13.85 (352) End 1 ID: 13.70 (348) End 2 ID: 7.44 (189)
AF4851  DONALDSON P124366 Overall Height: 14.50 (368) Overall OD: 8.64 (219) End 1 ID: 7.06 (179) End 2 ID: 0.90 (23)	AF4863  GUARDIAN G116454 Overall Height: 25.00 (635) Overall OD: 12.77 (324) End 1 ID: 8.36 (212)	AF4872  GMC 8994542 Overall Height: 3.00 (76) Overall OD: 7.94 (202) End 1 ID: 4.13 (105)
AF4853K  DONALDSON P148573 Primary Air Filter used with AF4103 Overall Height: 15.16 (385) Fin Diameter: 7.85 (200) End 2 OD: 6.08 (154) End 1 ID: 3.48 (88) End 2 ID: 0.67 (17)	AF4865M  ISUZU 1142151580 Primary Air Filter used with AF1767 Overall Height: 13.47 (342) Overall OD: 9.14 (232) End 1 ID: 5.87 (149) End 2 ID: 0.90 (23)	AF4874  CATERPILLAR 8N2556 Overall Height: 10.31 (262) Flange Diameter: 15.64 (397) End 2 OD: 12.78 (325) End 1 ID: 10.14 (258)
AF4855  UNITED AIR CLEANER V250C142FS Primary Air Filter used with AF1635 Overall Height: 14.00 (356) Overall OD: 5.31 (135) End 1 ID: 3.41 (87)	AF4866  ISUZU 1142151510 Overall Height: 14.26 (362) End 1 OD: 0.67 (17) End 2 OD: 6.41 (163) End 1 ID: 5.27 (134) End 2 ID: 6.39 (162)	AF4877  NISSAN D654601D20 Overall Height: 10.54 (268) Overall OD: 7.93 (201) End 1 ID: 5.33 (135) End 2 ID: 0.90 (23)



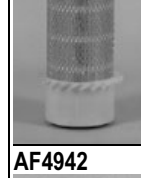

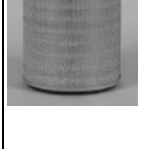





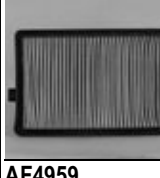

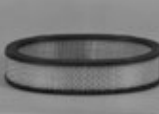

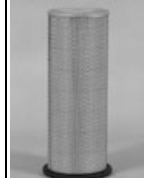



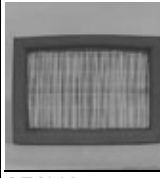

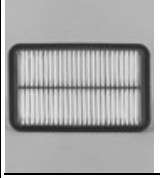
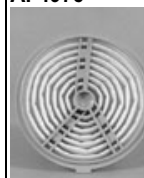

E. PRODUCT GUIDE

<p>AF4878</p>  <p>FORD F3HZ9601A, BLAW-KNOX 16480901 Primary Air Filter used with AF25215 Magnum RS Version</p> <p>Overall Height: 12.80 (325) Overall OD: 9.29 (236) End 1 ID: 5.20 (132)</p>	<p>AF4887KM</p>  <p>KOMATSU 3EC0111630 Primary Air Filter used with AF1966</p> <p>Overall Height: 11.50 (292) Fin Diameter: 8.03 (204) End 2 OD: 7.14 (181) End 1 ID: 2.71 (69) End 2 ID: 0.67 (17)</p>	<p>AF4896</p>  <p>MITSUBISHI ME033839 Safety Element used with AF4838, AF25060KM</p> <p>Overall Height: 16.25 (413) End 1 OD: 0.67 (17) End 2 OD: 5.21 (132) End 1 ID: 4.16 (106) End 2 ID: 5.21 (132)</p>
<p>AF4880</p>  <p>GMC 6422214</p> <p>Height: 7.13 (181) Length: 8.92 (227) Width: 8.02 (204)</p>	<p>AF4888K</p>  <p>J.C.B. 32205702 Primary Air Filter used with AF1892, AF4883 Seal included</p> <p>Overall Height: 15.46 (393) Fin Diameter: 6.34 (161) End 2 OD: 5.24 (133) End 1 ID: 3.17 (81) End 2 ID: 0.67 (17)</p>	<p>AF4897</p>  <p>DONALDSON P117370</p> <p>Overall Height: 18.50 (470) Overall OD: 10.40 (264) End 1 ID: 6.05 (154) End 2 ID: 0.90 (23)</p>
<p>AF4881</p>  <p>J.C.B. 32903002 Safety Element used with AF4890</p> <p>Overall Height: 9.08 (231) End 1 OD: 3.50 (89) End 2 OD: 2.72 (69) End 1 ID: 2.40 (61) End 2 ID: 0.67 (17)</p>	<p>AF4890</p>  <p>J.C.B. 32903001 Primary Air Filter used with AF4881</p> <p>Overall Height: 10.35 (263) Cover Diameter: 6.89 (175) End 2 OD: 5.87 (149) End 2 ID: 2.80 (71) Thread Size: M10 X 1.5-6H INT</p>	<p>AF4898</p>  <p>MERCEDES-BENZ 30941604 Safety Element used with AF4713 Seal included</p> <p>Overall Height: 17.78 (452) Overall OD: 7.11 (181) End 1 ID: 5.99 (152) End 2 ID: 0.67 (17)</p>
<p>AF4882</p>  <p>J.C.B. 32903202 Safety Element used with AF25509K, AF25311, AF1861K</p> <p>Overall Height: 9.98 (254) End 1 OD: 4.13 (105) End 2 OD: 3.35 (85) End 1 ID: 2.95 (75) End 2 ID: 0.67 (17)</p>	<p>AF4891M</p>  <p>JOHN DEERE RE35523, ORENSTEIN & KOPPEL 101158, SAME 242292001, DONALDSON P772552 Primary Air Filter used with AF4654</p> <p>Overall Height: 11.93 (303) Cover Diameter: 7.09 (180) End 2 OD: 6.30 (160) End 2 ID: 2.84 (72) Thread Size: 7/16-20 UNF-2B</p>	<p>AF4899</p>  <p>STEIGER 906017S1 Wing Nut Included</p> <p>Overall Height: 18.49 (470) Overall OD: 12.08 (307) End 1 ID: 7.73 (196) End 2 ID: 0.90 (23)</p>
<p>AF4883</p>  <p>J.C.B. 32205703 Safety Element used with AF4888K</p> <p>Overall Height: 13.96 (355) End 1 OD: 3.50 (89) End 2 OD: 2.72 (69) End 1 ID: 2.40 (61) End 2 ID: 0.67 (17)</p>	<p>AF4892K</p>  <p>J.C.B. 32903601 Primary Air Filter used with AF4103 Is a longer version of AF25509K Wing nut Included</p> <p>Overall Height: 15.50 (394) Cover Diameter: 8.37 (213) Fin Diameter: 7.85 (200) End 2 ID: 3.48 (89)</p>	<p>AF4901</p>  <p>LISTER PETTER 38207903</p> <p>Overall Height: 13.82 (351) Cover Diameter: 7.24 (184) End 2 OD: 5.51 (140) End 2 ID: 2.84 (72) Thread Size: 7/16-20 UNF-2B</p>
<p>AF4884</p>  <p>SCHROEDER ABF310 Air Breather with 3/4" NPT Adaptor</p> <p>Overall Height: 3.20 (81) Largest OD: 3.69 (94) Thread Size: 1 1/8-16 UN-2B</p>	<p>AF4893M</p>  <p>DONALDSON P772530 Primary Air Filter used with AF4589</p> <p>Overall Height: 16.46 (418) Cover Diameter: 11.02 (280) End 1 OD: 9.21 (234) End 1 ID: 4.84 (123) End 2 ID: 5.00 (127) Thread Size: 7/16-20 UNF-2B</p>	<p>AF4903</p>  <p>ISUZU 1142151810</p> <p>Overall Height: 15.50 (394) Overall OD: 10.87 (276) End 1 ID: 6.50 (165) End 2 ID: 0.92 (23)</p>
<p>AF4884A</p>  <p>STAUFF SGB9010P Air Breather w/o adaptor</p> <p>Overall Height: 3.20 (81) Largest OD: 3.69 (94) Thread Size: 1 1/8-16 UN-2B</p>	<p>AF4894KM</p>  <p>FIATAGRI 71415282 Primary Air Filter used with AF4589</p> <p>Overall Height: 16.46 (418) Cover Diameter: 11.02 (280) Fin Diameter: 10.08 (256) End 2 ID: 5.33 (135) Thread Size: 7/16-20 UNF-2B</p>	<p>AF4905M</p>  <p>LIEBHERR 7405233, POCLAIN M2150534 Primary Air Filter used with AF4589 Wing nut and seal included</p> <p>Overall Height: 16.26 (413) Cover Diameter: 11.02 (280) End 2 OD: 10.00 (254) End 2 ID: 4.88 (124) Thread Size: 7/16-20 UNF-2B</p>
<p>AF4886</p>  <p>CATERPILLAR 7W6754E Safety Element used with AF1890M</p> <p>Overall Height: 5.24 (133) Flange Diameter: 6.69 (170) End 2 OD: 3.95 (100) End 1 ID: 2.36 (60)</p>	<p>AF4895</p>  <p>VOLVO 15868821</p> <p>Overall Height: 3.64 (93) End 1 OD: 3.47 (88) End 2 OD: 3.31 (84) End 1 ID: 0.83 (21)</p>	<p>AF4906</p>  <p>IVECO 1902457</p> <p>Overall Height: 7.17 (182) Overall OD: 6.30 (160) End 1 ID: 3.94 (100)</p>

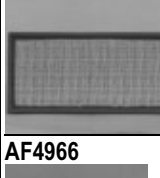



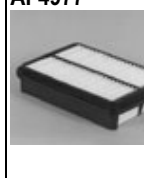





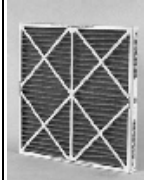

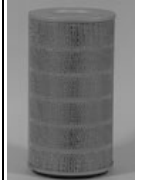





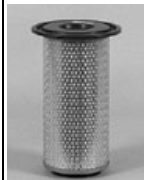

E. PRODUCT GUIDE

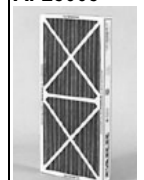
AF4907  IVECO 1902486 Overall Height: 9.29 (236) Overall OD: 6.30 (160) End 1 ID: 3.94 (100)	AF4917  MERCEDES-BENZ 30943904 Overall Height: 9.00 (229) Overall OD: 5.87 (149) End 1 ID: 2.80 (71) End 2 ID: 0.41 (11)	AF4928  IMPCO F115 Filter for Impco LP Gas conversion kits for S-10 Chevy and Ford pickups. Overall Height: 6.63 (168) Overall OD: 6.75 (171) End 1 ID: 5.00 (127)
AF4909K  MANITOU 177130 Primary Air Filter used with AF25321 Seal included Overall Height: 12.05 (306) Fin Diameter: 7.85 (200) End 2 OD: 6.08 (154) End 1 ID: 3.48 (88) End 2 ID: 0.67 (17)	AF4918  FORD 88VB9601AA Height: 2.28 (58) Length: 8.90 (226) Width: 9.45 (240)	AF4929  IMPCO F15 Filter for Impco LP Gas conversion kits for S-10 Chevy and Ford pickups. Overall Height: 2.13 (54) Overall OD: 6.75 (171) End 1 ID: 5.00 (127)
AF4910  RENAULT V.I. 5001000878 Overall Height: 12.17 (309) Overall OD: 4.92 (125) End 1 ID: 3.35 (85)	AF4919  VOLVO 47714738 Height: 1.54 (39) Length: 6.48 (165) Width: 13.19 (335)	AF4930  MITSUBISHI ME033773 Overall Height: 11.88 (302) End 1 OD: 0.67 (17) End 2 OD: 5.21 (132) End 1 ID: 4.16 (106)
AF4911  MITSUBISHI 9126108200 Seal included. Overall Height: 10.16 (258) Overall OD: 5.24 (133) End 1 ID: 3.17 (81) End 2 ID: 0.49 (13)	AF4920  IVECO 1905710, MANN & HUMMEL C331476 Overall Height: 18.72 (476) Overall OD: 12.89 (327) End 1 ID: 8.58 (218) End 2 ID: 0.41 (11)	AF4937  TOWMOTOR 369136 Overall Height: 10.50 (267) Overall OD: 4.31 (110) End 1 ID: 2.18 (55)
AF4912  DONALDSON P900438 Overall Height: 10.16 (258) Overall OD: 5.24 (133) End 1 ID: 3.17 (81) End 2 ID: 0.49 (13)	AF4923K  NISSAN 1654600H10, NISSAN 1654605H10 Overall Height: 8.03 (204) Fin Diameter: 5.20 (132) End 2 OD: 4.09 (104) End 1 ID: 2.52 (64) End 2 ID: 0.67 (17)	AF4939  KOMATSU 3EB0125830 Overall Height: 10.35 (263) Cover Diameter: 5.75 (146) End 2 OD: 4.08 (104) End 1 ID: 0.30 (8) End 2 ID: 2.56 (65)
AF4913  DONALDSON P900442 Overall Height: 10.16 (258) Overall OD: 5.24 (133) End 1 ID: 3.17 (81) End 2 ID: 0.49 (13)	AF4924  CLARK 2373789, TOWMOTOR 973999 Height: 1.64 (42) Length: 8.37 (212) Width: 8.37 (212)	AF4940  CATERPILLAR 2N7003 Replacement blanket for AF4128 Height: 0.50 (13) Length: 26.00 (660) Width: 24.00 (610)
AF4915  MERCEDES-BENZ 20949204 Height: 2.42 (62) Length: 6.77 (172) Width: 23.47 (596)	AF4926  DONALDSON P103988 Overall Height: 14.86 (377) Overall OD: 11.69 (297) End 1 ID: 5.52 (140)	AF4941K  Flame Retardant version of AF409K. 331624 Bolt Seal Included Overall Height: 12.43 (316) Fin Diameter: 7.85 (200) End 2 OD: 6.08 (154) End 1 ID: 3.48 (88) End 2 ID: 0.67 (17)
AF4916  MERCEDES-BENZ 20949304 Height: 3.17 (81) Length: 23.47 (596) Width: 6.77 (172)	AF4927  DONALDSON P103988 Primary Air Filter used with AF4867 Seal included Overall Height: 15.41 (392) Overall OD: 11.08 (281) End 1 ID: 6.73 (171) End 2 ID: 0.67 (17)	AF4942  VOLVO 1080918 Primary Air Filter used with AF25084 Overall Height: 23.56 (599) Cover Diameter: 13.19 (335) End 2 OD: 10.59 (269) End 2 ID: 6.22 (158)

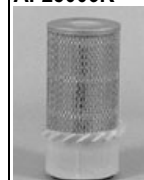









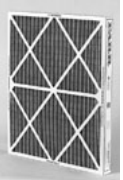
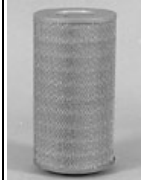



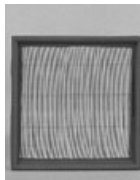



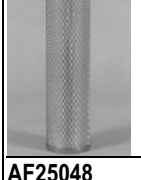

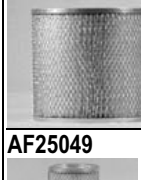
E. PRODUCT GUIDE

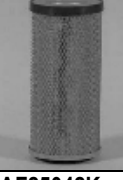
AF4944 MITSUBISHI MD603932  Height: 6.83 (173) Length: 8.06 (205) Width: 7.56 (192)	AF4958 HONDA 17220PH3000  Height: 1.30 (33) Length: 11.15 (283) Width: 7.36 (187)	AF4968 DAF 393561 Seal included  Overall Height: 14.81 (376) Overall OD: 9.54 (242) End 1 ID: 5.21 (132) End 2 ID: 0.41 (11)
AF4945 MOTORCRAFT FA1048  Height: 2.20 (56) Length: 10.72 (272) Width: 8.28 (210)	AF4959 TOYOTA 1780174020  Height: 1.65 (42) Length: 12.25 (311) Width: 6.19 (157)	AF4970 IVECO 107030 Safety Element used with AF4747 Seal included  Overall Height: 19.21 (488) End 1 OD: 8.43 (214) End 2 OD: 7.26 (185) End 1 ID: 6.24 (159) End 2 ID: 0.67 (17)
AF4946 AC A1129C  Height: 1.65 (42) Length: 11.57 (294) Width: 7.09 (180)	AF4960 MOTORCRAFT FA1061  Height: 1.58 (40) Length: 9.55 (243) Width: 9.55 (243)	AF4972 IVECO 1905983 Seal included  Overall Height: 11.67 (297) Overall OD: 9.54 (242) End 1 ID: 5.21 (132) End 2 ID: 0.41 (11)
AF4949 AC A1096C  Height: 1.70 (43) Length: 10.62 (270) Width: 7.94 (202)	AF4961 AC A1111C  Height: 1.56 (40) Length: 8.56 (217) Width: 6.16 (156)	AF4973K Seal included  Overall Height: 7.89 (201) Fin Diameter: 5.16 (131) End 2 OD: 4.08 (104) End 1 ID: 2.56 (65) End 2 ID: 0.67 (17)
AF4952 MITSUBISHI MD604880  Overall Height: 2.50 (64) Overall OD: 10.50 (267) End 1 ID: 7.94 (202)	AF4962 NISSAN 1654684A10  Overall Height: 1.75 (44) End 1 OD: 10.81 (275) End 2 OD: 6.75 (171) End 1 ID: 6.75 (171)	AF4974 NISSAN 1654689W00  Overall Height: 2.82 (72) Overall OD: 9.69 (246) End 1 ID: 8.12 (206)
AF4954 HONDA 17220PT2000  Height: 1.57 (40) Length: 9.59 (244) Width: 5.45 (138)	AF4964 TOYOTA 1780116020  Height: 1.70 (43) Length: 9.84 (250) Width: 6.10 (155)	AF4975 ISUZU 8944656560  Overall Height: 2.82 (72) Overall OD: 8.70 (221) End 1 ID: 1.08 (28)
AF4955 AC A925C  Overall Height: 5.94 (151) Overall OD: 5.75 (146) End 1 ID: 3.62 (92)	AF4965 CHRYSLER 53004583  Height: 1.57 (40) Length: 13.50 (343) Width: 6.62 (168)	AF4976 MAZDA JF0113Z40  Height: 1.50 (38) Length: 8.69 (221) Width: 7.38 (187)
AF4956 TOYOTA 1780170020  Overall Height: 2.81 (71) End 1 OD: 8.67 (220) End 2 OD: 7.55 (192) End 2 ID: 1.35 (34)	AF4966 VOLVO 10823680 Air breather on vehicles with air suspension. Is a longer version of AF4895  Overall Height: 5.20 (132) End 1 OD: 3.47 (88) End 2 OD: 3.31 (84) End 1 ID: 0.83 (21)	AF4977 TOYOTA 1780135020  Height: 2.05 (52) Length: 9.76 (248) Width: 6.65 (169)
AF4957 VOLVO 463505  Height: 1.44 (37) Length: 13.16 (334) Width: 6.38 (162)	AF4967 MOTORCRAFT FA1116  Overall Height: 13.88 (353) Overall OD: 7.38 (187) End 1 ID: 5.38 (137) End 2 ID: 0.39 (10)	

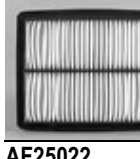
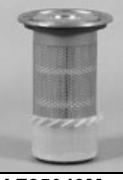









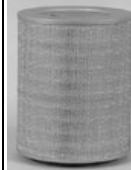
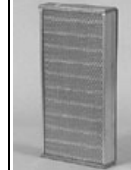

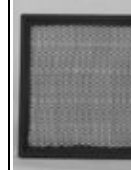





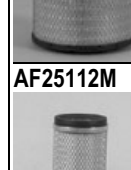

E. PRODUCT GUIDE

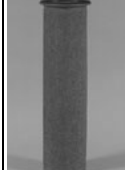
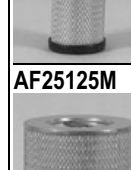
<p>AF4978 SUZUKI 1378083000</p>  <p>Overall Height: 4.37 (111) Overall OD: 7.24 (184) End 1 ID: 4.65 (118)</p>	<p>AF4988 FARR 498805</p>  <p>Height: 1.88 (48) Length: 23.38 (594) Width: 23.38 (594)</p>	<p>AF4996 FURUKAWA 1129112C1 Safety Element used with AF4995K Seal included</p>  <p>Overall Height: 14.37 (365) Overall OD: 4.08 (104) End 1 ID: 2.94 (75) End 2 ID: 0.67 (17)</p>
<p>AF4980KM BENFRA 40199, DONALDSON P772531 Primary Air Filter used with AF4761M Wing nut and seal included</p>  <p>Overall Height: 16.42 (417) Cover Diameter: 12.50 (318) Fin Diameter: 11.61 (295) End 2 OD: 10.39 (264) End 2 ID: 6.02 (153) Thread Size: 7/16-20 UNF-2B</p>	<p>AF4989 LEYLAND ABU6154 Seal included</p>  <p>Overall Height: 16.58 (421) Overall OD: 9.21 (234) End 1 ID: 4.86 (123) End 2 ID: 0.67 (17)</p>	<p>AF4999 FARR 52711000</p>  <p>Height: 5.25 (133) Length: 19.50 (495) Width: 19.50 (495)</p>
<p>AF4981M MASSEY-FERGUSON 3389793M2, FORD 452529 Primary Air Filter used with AF4761M Wing nut and seal included</p>  <p>Overall Height: 16.46 (418) Cover Diameter: 12.48 (317) End 2 OD: 9.76 (248) End 2 ID: 6.06 (154) Thread Size: 7/16-20 UNF-2B</p>	<p>AF4990 VOLVO V1115700</p>  <p>Overall Height: 16.75 (425) Overall OD: 12.74 (324) End 1 ID: 8.36 (212)</p>	<p>AF25000 AWD 91112964 Seal Included</p>  <p>Overall Height: 14.39 (366) End 1 OD: 8.94 (227) End 2 OD: 7.72 (196) End 1 ID: 0.63 (16) End 2 ID: 5.06 (129)</p>
<p>AF4983 FIATAGRI 1930537, DONALDSON P770207 Safety Element used with AF25002M Seal included</p>  <p>Overall Height: 12.07 (307) End 1 OD: 3.62 (92) End 2 OD: 2.72 (69) End 1 ID: 2.40 (61) End 2 ID: 0.67 (17)</p>	<p>AF4991 KUBOTA 1735111080</p>  <p>Overall Height: 11.54 (293) Cover Diameter: 7.05 (179) End 2 OD: 5.24 (133) End 1 ID: 0.53 (14) End 2 ID: 2.84 (72)</p>	<p>AF25002M FIATAGRI 1930536, DONALDSON P772565 Primary Air Filter used with AF4983 Wing Nut Included</p>  <p>Overall Height: 13.82 (351) Cover Diameter: 7.24 (184) End 2 OD: 5.43 (138) End 2 ID: 2.84 (72) Thread Size: 7/16-20 UNF-2B</p>
<p>AF4984 RENAULT V.I. 5000814696 Primary Air Filter used with AF25061 Seal included</p>  <p>Overall Height: 16.45 (418) Cover Diameter: 14.73 (374) End 2 OD: 11.69 (297) End 2 ID: 7.46 (190)</p>	<p>AF4992 LEYLAND 192720 Seal included</p>  <p>Overall Height: 11.40 (290) Overall OD: 5.24 (133) End 1 ID: 2.71 (69) End 2 ID: 0.67 (17)</p>	<p>AF25005 FARR 49880006 Uses service part: 3847372S</p>  <p>Height: 1.88 (48) Length: 23.38 (594) Width: 11.38 (289)</p>
<p>AF4985 HEAVY DUTY AIR A0337 For use on MCI bus coaches 2556017 Bolt Seal Included</p>  <p>Overall Height: 16.02 (407) End 1 OD: 15.80 (401) End 2 OD: 15.11 (384) End 1 ID: 0.90 (23) End 2 ID: 8.21 (208)</p>	<p>AF4993 DAF 192057 Seal included</p>  <p>Overall Height: 8.64 (220) Overall OD: 5.24 (133) End 1 ID: 2.82 (72) End 2 ID: 0.67 (17)</p>	<p>AF25006K MANITOU 177129, SOFILTRA 123607 Primary Air Filter used with AF25753 Seal included</p>  <p>Overall Height: 11.12 (283) Fin Diameter: 6.34 (161) End 2 OD: 5.24 (133) End 1 ID: 2.71 (69) End 2 ID: 0.67 (17)</p>
<p>AF4986 HEAVY DUTY AIR A02040</p>  <p>Overall Height: 16.74 (425) End 1 OD: 12.79 (325) End 2 OD: 12.77 (324) End 2 ID: 8.36 (212)</p>	<p>AF4994 FIATAGRI 1930175 Safety Element used with AF25057, AF25331 Seal included</p>  <p>Overall Height: 12.43 (316) Overall OD: 4.61 (117) End 1 ID: 3.56 (90) End 2 ID: 0.67 (17)</p>	<p>AF25007 VOLVO 6888848</p>  <p>Overall Height: 16.70 (424) Overall OD: 14.38 (365) End 1 ID: 8.27 (210) End 2 ID: 0.40 (10)</p>
<p>AF4986 HEAVY DUTY AIR A02040</p>  <p>Overall Height: 16.74 (425) End 1 OD: 12.79 (325) End 2 OD: 12.77 (324) End 2 ID: 8.36 (212)</p>	<p>AF4995K FURUKAWA 1129111C1 Primary Air Filter used with AF4996 Seal included</p>  <p>Overall Height: 15.50 (394) Fin Diameter: 8.88 (226) End 2 OD: 6.85 (174) End 1 ID: 4.23 (108) End 2 ID: 0.67 (17)</p>	<p>AF25008 HITACHI 4247974 Safety Element used with AF25009 Seal included</p>  <p>Overall Height: 9.63 (245) Overall OD: 5.16 (131) End 1 ID: 4.06 (103) End 2 ID: 0.67 (17)</p>

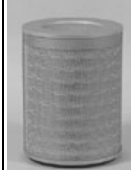



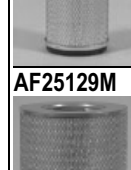









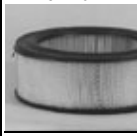

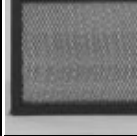



E. PRODUCT GUIDE

<p>AF25009 HITACHI 4206098 Primary Air Filter used with AF25008 Seal Included</p>  <p>Gasket: 3830497 Overall Height: 10.93 (278) Cover Diameter: 9.92 (252) End 2 OD: 7.93 (201) End 1 ID: 0.87 (22) End 2 ID: 5.33 (135)</p>	<p>AF25024 FARR 49880012</p>  <p>Height: 1.88 (48) Length: 23.50 (597) Width: 19.50 (495)</p>	<p>AF25044M DAF 265045 Primary Air Filter used with AF1840</p>  <p>Overall Height: 14.81 (376) Overall OD: 7.78 (198) End 1 ID: 4.08 (104) End 2 ID: 0.34 (9)</p>
<p>AF25010 LEYLAND ASU1816</p>  <p>Overall Height: 6.46 (164) Overall OD: 5.75 (146) End 1 ID: 3.54 (90)</p>	<p>AF25029 NEW HOLLAND 1930349</p>  <p>Overall Height: 13.47 (342) Cover Diameter: 10.75 (273) End 2 OD: 10.00 (254) End 2 ID: 4.82 (122)</p>	<p>AF25045M DAF 667078 Primary Air Filter used with AF4727</p>  <p>Overall Height: 14.81 (376) End 1 OD: 11.88 (302) End 2 OD: 11.84 (301) End 1 ID: 7.55 (192) End 2 ID: 0.41 (11)</p>
<p>AF25013 V.A.G. (VOLKSWAGEN, AUDI) 21129620</p>  <p>Height: 8.38 (213) Length: 8.38 (213) Width: 2.25 (57)</p>	<p>AF25031 KOMATSU 6001819460 Wing nut included AF25444 is the same element without wing nut</p>  <p>Overall Height: 12.44 (316) Cover Diameter: 7.60 (193) End 2 OD: 6.08 (154) End 2 ID: 3.48 (88)</p>	<p>AF25046 KOMATSU 6001818210 Primary Air Filter used with AF25047</p>  <p>Overall Height: 16.75 (425) Overall OD: 8.48 (215) End 1 ID: 4.17 (106) End 2 ID: 0.63 (16)</p>
<p>AF25014 CHRYSLER 4300787</p>  <p>Overall Height: 3.06 (78) End 1 OD: 13.00 (330) End 2 OD: 9.12 (232) End 1 ID: 9.81 (249) End 2 ID: 5.94 (151)</p>	<p>AF25033M CASE 2005895C1 Primary Air Filter used with AF25430</p>  <p>Overall Height: 18.63 (473) End 1 OD: 13.05 (331) End 2 OD: 12.90 (328) End 1 ID: 6.78 (172)</p>	<p>AF25047 KOMATSU 6001818310 Safety Element used with AF25046</p>  <p>Overall Height: 15.50 (394) End 1 OD: 0.63 (16) End 2 OD: 4.10 (104) End 1 ID: 2.92 (74)</p>
<p>AF25015 CHRYSLER 4287141</p>  <p>Overall Height: 2.69 (68) Overall OD: 12.34 (313) End 1 ID: 9.16 (233)</p>	<p>AF25040 DONALDSON P526678 Magnum RS Version</p>  <p>Overall Height: 15.10 (384) End 1 OD: 9.38 (238) End 2 OD: 9.23 (234) End 1 ID: 5.21 (132)</p>	<p>AF25048 KOMATSU 6675817231</p>  <p>Overall Height: 8.85 (225) Overall OD: 9.65 (245) End 1 ID: 5.25 (133)</p>
<p>AF25016 MITSUBISHI MD620047</p>  <p>Overall Height: 3.14 (80) Overall OD: 9.28 (236) End 1 ID: 6.72 (171)</p>	<p>AF25041 NISSAN 1654606N00 Flame Retardant Media</p>  <p>Overall Height: 11.44 (291) End 1 OD: 5.36 (136) End 2 OD: 5.24 (133) End 2 ID: 2.82 (72)</p>	<p>AF25049 KOMATSU 6675817031</p>  <p>Overall Height: 17.00 (432) Overall OD: 5.09 (129) End 1 ID: 3.81 (97) End 2 ID: 0.42 (11)</p>
<p>AF25017 AC A1138C</p>  <p>Height: 1.70 (43) Length: 10.11 (257) Width: 8.24 (209)</p>	<p>AF25042K TOYOTA 178062380071</p>  <p>Overall Height: 11.54 (293) Cover Diameter: 7.76 (197) Fin Diameter: 6.34 (161) End 1 ID: 0.47 (12) End 2 ID: 2.72 (69)</p>	<p>AF25055 LEYLAND ACU8498 Seal included.</p>  <p>Overall Height: 15.54 (395) Overall OD: 9.21 (234) End 1 ID: 4.86 (124) End 2 ID: 0.67 (17)</p>
<p>AF25022 MERCEDES-BENZ 30947004 Seal included.</p>  <p>Overall Height: 18.95 (481) Overall OD: 12.89 (327) End 1 ID: 7.66 (195) End 2 ID: 0.41 (11)</p>	<p>AF25043M DAF 112294 Primary Air Filter used with AF1841</p>  <p>Overall Height: 15.03 (382) Overall OD: 8.96 (228) End 1 ID: 4.61 (117) End 2 ID: 0.41 (11)</p>	<p>AF25056K LEYLAND RTC3478, CROSLAND 9668K Seal included.</p>  <p>Overall Height: 8.64 (220) Fin Diameter: 6.34 (161) End 2 OD: 5.24 (133) End 1 ID: 2.72 (69) End 2 ID: 0.67 (17)</p>
<p>AF25023 MOPAR 4713953 Magnum RS Version</p>  <p>Gasket: 3895660 Overall Height: 9.98 (253) End 1 OD: 8.21 (209) End 2 OD: 8.06 (205) End 1 ID: 4.18 (106)</p>		







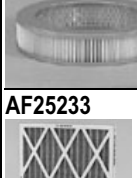
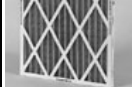







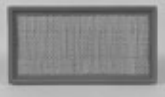









E. PRODUCT GUIDE

<p>AF25057 FIATAGRI 1930174, FIATAGRI 1930349 Primary Air Filter used with AF4994</p>  <p>Overall Height: 13.35 (339) Cover Diameter: 10.95 (278) End 2 OD: 10.00 (254) End 2 ID: 4.88 (124) Thread Size: 7/16-20 UNF-2B</p>	<p>AF25066 SCANIA 395773 Primary Air Filter used with AF4727 except for Daf--use AF25045M. Seal included</p>  <p>Overall Height: 14.94 (379) End 1 OD: 11.89 (302) End 2 OD: 11.84 (301) End 1 ID: 7.56 (192) End 2 ID: 0.41 (11)</p>	<p>AF25089 HITACHI 4206637</p>  <p>Height: 2.69 (68) Length: 17.13 (435) Width: 8.47 (215)</p>
<p>AF25058 JOHN DEERE AT762159</p>  <p>Overall Height: 13.38 (340) Overall OD: 7.31 (186) End 1 ID: 4.00 (102) End 2 ID: 0.38 (10)</p>	<p>AF25067 CASE 7825516</p>  <p>Overall Height: 3.22 (82) Largest OD: 3.31 (84) Thread Size: 3/4-16 UNF-2B</p>	<p>AF25090 CHRYSLER 4728406</p>  <p>Height: 2.30 (58) Length: 11.81 (300) Width: 10.75 (273)</p>
<p>AF25060KM KOMATSU 2050173750 Primary Air Filter used with AF25318, AF4896</p>  <p>Overall Height: 17.74 (451) Cover Diameter: 11.02 (280) Fin Diameter: 10.08 (256) End 2 ID: 5.33 (135) Thread Size: 7/16-20 UNF-2B</p>	<p>AF25069 MERCEDES-BENZ 30945104 Half housing attached</p>  <p>Overall Height: 13.11 (333) End 1 OD: 7.48 (190) End 2 OD: 6.18 (157) End 1 ID: 2.76 (70)</p>	<p>AF25091 CUMMINS 3040098</p>  <p>Overall Height: 6.00 (152) Overall OD: 11.50 (292) End 1 ID: 9.50 (241)</p>
<p>AF25061 RENAULT V.I. 5000814947 Safety Element used with AF4984</p>  <p>Overall Height: 14.76 (375) Overall OD: 7.40 (188) End 1 ID: 6.30 (160) End 2 ID: 0.57 (15)</p>	<p>AF25070K NISSAN 1654602N00 Seal included</p>  <p>Overall Height: 11.40 (290) Fin Diameter: 6.34 (161) End 2 OD: 5.24 (133) End 1 ID: 2.82 (72) End 2 ID: 0.67 (17)</p>	<p>AF25092M Kenworth T8000 and Reyton IT-3700 Applications</p>  <p>Overall Height: 24.30 (617) Overall OD: 8.14 (207) End 1 ID: 10.87 (276) End 2 ID: 8.09 (205)</p>
<p>AF25062 M.A.N. 81084016082 Primary Air Filter used with AF25230 Seal included</p>  <p>Overall Height: 24.35 (618) End 1 OD: 12.91 (328) End 2 OD: 12.89 (328) End 1 ID: 8.56 (218) End 2 ID: 0.41 (11)</p>	<p>AF25075 VOLKSWAGEN 2VC129619</p>  <p>Overall Height: 15.43 (392) End 1 OD: 6.59 (167) End 1 ID: 4.11 (104)</p>	<p>AF25111M CATERPILLAR 6I2499 Primary Air Filter used with AF25112M Magnum RS Version of AF344M</p>  <p>Overall Height: 12.32 (313) End 1 OD: 9.19 (234) End 2 OD: 9.06 (230) End 1 ID: 4.63 (118)</p>
<p>AF25063 CHAUMECA CH4S</p>  <p>Overall Height: 10.55 (268) Overall OD: 8.27 (210) End 1 ID: 5.51 (140) End 2 ID: 5.51 (140)</p>	<p>AF25084 VOLVO 1080920 Safety Element used with AF4942</p>  <p>Overall Height: 22.84 (580) End 1 OD: 6.77 (172) End 2 OD: 5.83 (148) End 1 ID: 5.39 (137) End 2 ID: 0.39 (10)</p>	<p>AF25112M CATERPILLAR 6I2500 Safety Element used with AF25111M Magnum RS Version of AF343M</p>  <p>Overall Height: 11.58 (294) End 1 OD: 4.69 (119) End 2 OD: 4.49 (114) End 1 ID: 3.19 (81)</p>
<p>AF25064 SCANIA 218989 Primary Air Filter used with AF1840</p>  <p>Overall Height: 14.81 (376) Overall OD: 7.78 (198) End 1 ID: 4.08 (104) End 2 ID: 0.34 (9)</p>	<p>AF25087 LEYLAND ACU8456 Seal included</p>  <p>Overall Height: 14.54 (369) Overall OD: 11.08 (281) End 1 ID: 6.73 (171) End 2 ID: 0.67 (17)</p>	<p>AF25125M CATERPILLAR 6I2501 Primary Air Filter used with AF25126M Magnum RS Version</p>  <p>Overall Height: 13.23 (336) End 1 OD: 11.06 (281) End 2 OD: 10.97 (279) End 1 ID: 5.91 (150)</p>
<p>AF25065 MERCEDES-BENZ 10944704 Primary Air Filter used with AF1841</p>  <p>Overall Height: 15.03 (382) Overall OD: 8.96 (228) End 1 ID: 4.61 (117) End 2 ID: 0.41 (11)</p>	<p>AF25088 KOMATSU 6675817021</p>  <p>Overall Height: 9.85 (250) Overall OD: 9.65 (245) End 1 ID: 5.25 (133)</p>	<p>AF25126M CATERPILLAR 6I2502 Safety Element used with AF25125M Magnum RS Version</p>  <p>Overall Height: 12.44 (316) End 1 OD: 5.93 (151) End 2 OD: 5.59 (142) End 1 ID: 4.11 (105)</p>
		<p>AF25129M CATERPILLAR 6I2503 Primary Air Filter used with AF25130M</p>  <p>Overall Height: 16.28 (414) End 1 OD: 11.06 (281) End 2 OD: 10.97 (279) End 1 ID: 5.91 (150)</p>















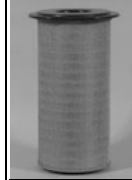
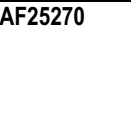





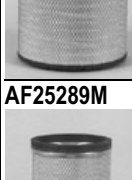

E. PRODUCT GUIDE

AF25130M 	CATERPILLAR 6I2504 Safety Element used with AF25129M Magnum RS Version Overall Height: 15.67 (398) End 1 OD: 5.93 (151) End 2 OD: 5.59 (142) End 1 ID: 4.11 (105)	AF25200K 	HITACHI 4294845 Seal included Overall Height: 7.50 (191) Cover Diameter: 5.04 (128) End 2 OD: 3.31 (84) End 1 ID: 0.41 (11) End 2 ID: 1.69 (43)	AF25225 	M.A.N. 81083040069 Safety Element used with AF25222 Overall Height: 13.19 (335) End 1 OD: 6.38 (162) End 2 OD: 6.10 (155) End 1 ID: 5.53 (141) End 2 ID: 0.67 (17)
AF25131M 	CATERPILLAR 6I0273 Primary Air Filter used with AF25132M Magnum RS Version of AF875M Overall Height: 13.33 (339) End 1 OD: 11.48 (292) End 2 OD: 11.34 (288) End 1 ID: 7.19 (183)	AF25211 	AF4138 with gasket 3320720. Overall Height: 9.61 (244) Overall OD: 6.85 (174) End 1 ID: 4.23 (108) End 2 ID: 0.67 (17)	AF25226 	FORD F1UZ9601A V8 Engine Overall Height: 4.40 (112) Overall OD: 11.56 (294) End 1 ID: 8.28 (210)
AF25132M 	CATERPILLAR 6I0274 Safety Element used with AF25131M Magnum RS Version Overall Height: 13.15 (334) End 1 OD: 7.26 (185) End 2 OD: 6.89 (175) End 1 ID: 5.20 (132)	AF25215 	FORD F3HZ9602A Safety Element used with AF4878 Overall Height: 12.01 (305) End 1 OD: 5.20 (132) End 2 OD: 4.96 (126) End 1 ID: 3.70 (94)	AF25227 	MOTORCRAFT FA1605 Height: 2.34 (59) Length: 10.50 (267) Width: 8.34 (212)
AF25135M 	CATERPILLAR 6I2505 Primary Air Filter used with AF25136M Magnum RS Version Overall Height: 15.37 (391) End 1 OD: 12.48 (317) End 2 OD: 12.36 (314) End 1 ID: 8.21 (209)	AF25218 	AIR MAZE CD1623610827 Safety Element used with AF4678 Filter used with AH1151 Overall Height: 20.75 (527) Overall OD: 7.38 (187) End 1 ID: 6.12 (155) End 2 ID: 0.64 (16)	AF25228M 	JOHN DEERE AZ45868 Primary Air Filter used with AF25229M Seal included Overall Height: 22.51 (572) End 1 OD: 12.09 (307) End 2 OD: 12.03 (306) End 1 ID: 7.74 (197) End 2 ID: 0.67 (17)
AF25136M 	CATERPILLAR 6I2506 Safety Element used with AF25135M Magnum RS Version Overall Height: 15.32 (389) End 1 OD: 8.27 (210) End 2 OD: 7.84 (199) End 1 ID: 6.14 (156)	AF25219 	DONALDSON P531026 Overall Height: 23.51 (597) End 1 OD: 9.38 (238) End 2 OD: 9.23 (234) End 1 ID: 5.87 (149)	AF25229M 	JOHN DEERE AZ45867 Safety Element used with AF25228M Seal included Overall Height: 21.58 (548) End 1 OD: 8.43 (214) End 2 OD: 7.26 (185) End 1 ID: 6.23 (158) End 2 ID: 0.67 (17)
AF25137M 	CATERPILLAR 6I2509 Primary Air Filter used with AF25138M Magnum RS Version Overall Height: 18.86 (479) End 1 OD: 12.40 (315) End 2 OD: 12.36 (314) End 1 ID: 8.21 (209)	AF25221 	KUBOTA 1142011180 Overall Height: 1.99 (51) End 1 OD: 4.72 (120) End 2 OD: 4.41 (112) End 2 ID: 2.09 (53)	AF25230 	M.A.N. 81083040066 Safety Element used with AF25062 Overall Height: 23.98 (609) End 1 OD: 8.31 (211) End 2 OD: 7.95 (202) End 1 ID: 7.48 (190) End 2 ID: 0.67 (17)
AF25138M 	CATERPILLAR 6I2510 Safety Element used with AF25137M Magnum RS version Overall Height: 18.98 (482) End 1 OD: 8.27 (210) End 2 OD: 7.44 (189) End 1 ID: 6.14 (156)	AF25222 	M.A.N. 81082040072 Primary Air Filter used with AF25225 Seal included Overall Height: 13.36 (339) End 1 OD: 11.88 (302) End 2 OD: 11.84 (301) End 1 ID: 7.55 (192) End 2 ID: 0.41 (11)	AF25231 	HINO 178012440 Overall Height: 11.02 (280) Overall OD: 7.48 (190) End 1 ID: 0.89 (23)
AF25139M 	DONALDSON P527682 Primary Air Filter used with AF25345 Magnum RS version. Overall Height: 15.40 (391) End 1 OD: 13.13 (334) End 2 OD: 12.90 (328) End 1 ID: 6.80 (173)	AF25224K 	LEYLAND ACU8916 Seal included Overall Height: 15.54 (395) Boot Diameter: 0.67 (17) Fin Diameter: 9.96 (253) End 2 OD: 7.93 (201) End 1 ID: 5.33 (135)	AF25232 	SUZUKI 1378078100 Overall Height: 1.79 (45) Overall OD: 8.37 (213) End 1 ID: 6.30 (160)
				AF25233 	FARR 119303004 Height: 0.75 (19) Length: 24.50 (622) Width: 15.50 (394)











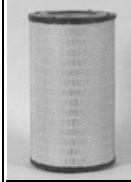

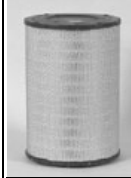

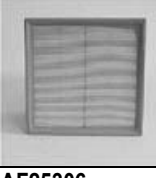

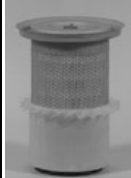



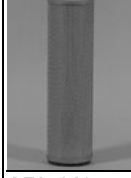

E. PRODUCT GUIDE

<p>AF25234 FARR 119303005</p>  <p>Height: 0.75 (19) Length: 23.50 (597) Width: 23.50 (597)</p>	<p>AF25246 IVECO 1908234</p>  <p>Overall Height: 9.88 (251) Overall OD: 6.10 (155) End 1 ID: 3.07 (78)</p>	<p>AF25255 FORD F5TZ9601A, MOTORCRAFT FA1617</p>  <p>Height: 6.02 (153) Length: 12.93 (328) Width: 6.19 (157)</p>
<p>AF25235 IVECO 1907695</p>  <p>Overall Height: 20.27 (515) Overall OD: 12.89 (327) End 1 ID: 8.58 (218) End 2 ID: 0.41 (11)</p>	<p>AF25247 Is a longer version of AF25858 Magnum RS version</p>  <p>Gasket: 3309167 (1) Overall Height: 23.94 (608) End 1 OD: 11.30 (287) End 2 OD: 11.15 (283) End 1 ID: 6.78 (172)</p>	<p>AF25256 AC A1163C, GMC 25098463</p>  <p>Height: 1.65 (42) Length: 11.52 (293) Width: 6.01 (153)</p>
<p>AF25237 DAF 754718 Magnum RS version</p>  <p>Overall Height: 16.56 (421) End 1 OD: 9.65 (245) End 2 OD: 9.53 (242) End 1 ID: 4.98 (127)</p>	<p>AF25248 DONALDSON P534925 Magnum RS version, Peterbilt Model 379</p>  <p>Overall Height: 26.10 (663) End 1 OD: 12.95 (329) End 2 OD: 12.80 (325) End 1 ID: 7.45 (189)</p>	<p>AF25257 STEIGER 604452T2</p>  <p>Height: 1.28 (32) Length: 13.18 (335) Width: 5.25 (133)</p>
<p>AF25238 VOLVO 1665898 Primary Air Filter used with AF25317 Magnum RS version</p>  <p>Overall Height: 16.61 (422) Cover Diameter: 15.95 (405) End 2 OD: 12.91 (328) End 2 ID: 7.84 (199)</p>	<p>AF25249M RENAULT V.I. 5010066304 Primary Air Filter used with AF4867, AF820M</p>  <p>Overall Height: 18.49 (470) End 1 OD: 12.09 (307) End 2 OD: 12.07 (307) End 1 ID: 7.74 (197) End 2 ID: 0.67 (17)</p>	<p>AF25258 GMC 15998574 Magnum RS version</p>  <p>Overall Height: 10.65 (271) Overall OD: 6.49 (165) End 1 ID: 3.58 (91)</p>
<p>AF25239 VOLVO 16659088 Primary Air Filter used with AF25317 Magnum RS version</p>  <p>Overall Height: 16.52 (420) Cover Diameter: 16.89 (429) End 2 OD: 13.78 (350) End 2 ID: 7.80 (198)</p>	<p>AF25250 RENAULT V.I. 5000814957 Safety Element used with AF25285</p>  <p>Overall Height: 13.23 (336) Overall OD: 7.40 (188) End 1 ID: 0.56 (14) End 2 ID: 6.30 (160)</p>	<p>AF25259 GMC 15986275 Magnum RS version</p>  <p>Overall Height: 10.65 (271) Overall OD: 7.24 (184) End 1 ID: 3.58 (91)</p>
<p>AF25240 CHRYSLER MD604952</p>  <p>Overall Height: 2.15 (55) End 1 OD: 12.91 (328) End 2 OD: 9.06 (230) End 1 ID: 9.92 (252) End 2 ID: 6.02 (153)</p>	<p>AF25251 RENAULT V.I. 5000814950 Safety Element used with AF25285</p>  <p>Overall Height: 12.76 (324) Overall OD: 7.01 (178) End 1 ID: 6.10 (155)</p>	<p>AF25260 IVECO 1908233</p>  <p>Overall Height: 13.50 (343) Overall OD: 6.10 (155) End 1 ID: 3.19 (81)</p>
<p>AF25241 NISSAN 1654697002</p>  <p>Overall Height: 15.93 (405) Overall OD: 6.02 (153) End 1 ID: 4.76 (121)</p>	<p>AF25252 RENAULT V.I. 5000294118 Renault AE cabins</p>  <p>Height: 1.97 (50) Length: 10.67 (271) Width: 11.30 (287)</p>	<p>AF25261 Gardner Denver Compressors</p>  <p>Overall Height: 11.71 (297) Overall OD: 9.61 (244) End 1 ID: 5.14 (131)</p>
<p>AF25242 NISSAN 1654697001</p>  <p>Overall Height: 16.46 (418) Overall OD: 8.98 (228) End 1 ID: 6.26 (159)</p>	<p>AF25254 FORD F57X9601A</p>  <p>Overall Height: 7.90 (201) End 1 OD: 6.09 (155) End 2 OD: 5.04 (128) End 1 ID: 3.30 (84)</p>	<p>AF25262 CATERPILLAR 1063969, FRAM CA8492 Primary Air Filter used with AF25263 Magnum RS version</p>  <p>Overall Height: 18.35 (466) End 1 OD: 14.27 (363) End 2 OD: 14.13 (359) End 1 ID: 8.98 (228)</p>
<p>AF25243 HONDA 17220PE3601</p>  <p>Overall Height: 2.48 (63) Overall OD: 10.24 (260) End 1 ID: 7.64 (194)</p>		<p>AF25263 CATERPILLAR 1063973 Safety Element used with AF25262 Magnum RS Version</p>  <p>Overall Height: 17.72 (450) End 1 OD: 9.06 (230) End 2 OD: 8.66 (220) End 1 ID: 7.01 (178)</p>



















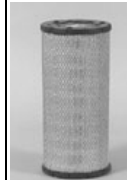



E. PRODUCT GUIDE

<p>AF25264 M.A.N. 81083040083 Primary Air Filter used with AF25615 Magnum RS Version</p>  <p>Overall Height: 19.00 (483) End 1 OD: 11.87 (302) End 2 OD: 11.93 (303) End 1 ID: 6.69 (170)</p>	<p>AF25285 RENAULT V.I. 5000814945 Primary Air Filter used with AF25250, AF25251</p>  <p>Overall Height: 14.68 (373) Cover Diameter: 14.33 (364) End 2 OD: 11.02 (280) End 1 ID: 0.63 (16) End 2 ID: 7.48 (190)</p>	<p>AF25293M PEGASO 171686</p>  <p>Overall Height: 20.52 (521) End 1 OD: 12.08 (307) End 2 OD: 12.02 (305) End 1 ID: 7.73 (196) End 2 ID: 0.67 (17)</p>
<p>AF25265 BOMAG 5821003</p>  <p>Overall Height: 3.01 (77) Overall OD: 3.33 (85) End 1 ID: 2.36 (60)</p>	<p>AF25286 RENAULT V.I. 5000814946</p>  <p>Overall Height: 16.26 (413) Cover Diameter: 9.92 (252) End 2 OD: 8.66 (220) End 2 ID: 3.70 (94)</p>	<p>AF25294 VOLVO 16655631 Primary Air Filter used with AF4558</p>  <p>Overall Height: 21.64 (550) Cover Diameter: 12.32 (313) End 2 OD: 10.12 (257) End 2 ID: 6.34 (161)</p>
<p>AF25270 DONGFENG MOTOR CORPORATION 1109N020 Primary Air Filter used with AF25271</p> 	<p>AF25287K MITSUBISHI 9186101600</p>  <p>Overall Height: 12.29 (312) Fin Diameter: 7.85 (200) End 2 OD: 6.08 (154) End 1 ID: 3.48 (88) End 2 ID: 0.67 (17)</p>	<p>AF25295 TOYOTA 1780154080</p>  <p>Overall Height: 7.80 (198) Overall OD: 6.04 (153) End 1 ID: 3.52 (89)</p>
<p>AF25278 CUMMINS 3630778 Filter used with AH19036</p>  <p>Overall Height: 18.49 (470) Cover Diameter: 16.41 (417) End 2 OD: 13.83 (351) End 2 ID: 9.48 (241)</p>	<p>AF25288M CATERPILLAR 612507 Primary Air Filter used with AF25289M Magnum RS Version.</p>  <p>Overall Height: 15.02 (382) Overall OD: 12.50 (318) End 1 ID: 8.20 (208)</p>	<p>AF25296 PEUGEOT 1444A0</p>  <p>Overall Height: 11.26 (286) Overall OD: 6.65 (169) End 1 ID: 3.19 (81)</p>
<p>AF25279 CATERPILLAR 611450 Primary Air Filter used with AF25280</p>  <p>Overall Height: 6.73 (171) End 1 OD: 8.21 (209) End 2 OD: 8.06 (205) End 1 ID: 4.18 (106)</p>	<p>AF25289M CATERPILLAR 612508 Safety Element used with AF25288M Magnum RS version</p>  <p>Overall Height: 11.77 (299) End 1 OD: 8.27 (210) End 2 OD: 7.44 (189) End 1 ID: 6.14 (156)</p>	<p>AF25299 DONALDSON P531138</p>  <p>Overall Height: 13.95 (354) Overall OD: 19.30 (490) End 1 ID: 12.88 (327) End 2 ID: 12.90 (328)</p>
<p>AF25280 CATERPILLAR 611451 Safety Element used with AF25279 Magnum RS Version</p>  <p>Overall Height: 5.83 (148) End 1 OD: 4.25 (108) End 2 OD: 4.02 (102) End 1 ID: 2.60 (66)</p>	<p>AF25290 FIATAGRI 1930591 Primary Air Filter used with AF25434</p>  <p>Overall Height: 11.58 (294) Overall OD: 4.11 (105) End 1 ID: 2.38 (61)</p>	<p>AF25300 JOHN DEERE AL78223 Primary Air Filter used with AF25301</p>  <p>Overall Height: 12.21 (310) Fin Diameter: 9.29 (236) End 2 OD: 7.28 (185) End 1 ID: 3.60 (92) End 2 ID: 3.66 (93)</p>
<p>AF25281 CATERPILLAR 1029388 Primary Air Filter used with AF25282</p>  <p>Overall Height: 7.54 (192) End 1 OD: 8.21 (209) End 2 OD: 8.06 (205) End 1 ID: 4.18 (106)</p>	<p>AF25291 FIATAGRI 1930587 Primary Air Filter used with AF25484 Magnum RS Version</p>  <p>Overall Height: 12.78 (325) Overall OD: 5.59 (142) End 1 ID: 3.25 (83)</p>	<p>AF25301 JOHN DEERE AL78224 Safety Element used with AF25300</p>  <p>Overall Height: 5.08 (129) Cover Diameter: 7.84 (199) End 2 OD: 5.02 (128) End 1 ID: 3.64 (93)</p>
<p>AF25282 CATERPILLAR 1029387 Safety Element used with AF25281 Magnum RS version</p>  <p>Overall Height: 6.69 (170) End 1 OD: 4.25 (108) End 2 OD: 4.02 (102) End 1 ID: 2.60 (66)</p>	<p>AF25292 FIATAGRI 1930589, OMNIQUIP PARTS WORLDWIDE 8035098 Primary Air Filter used with AF25485 Magnum RS version Outer body is made of perforated metal, with 2 non-perforated sections in the body</p>  <p>Overall Height: 13.78 (350) Overall OD: 6.50 (165) End 1 ID: 3.64 (93)</p>	<p>AF25302 FORD E9NN9B618BA Primary Air Filter used with AF25303 Used on Ford 4700K series tractor - Kubota Engine</p>  <p>Overall Height: 13.12 (333) End 1 OD: 8.05 (204) End 2 OD: 7.44 (189) End 1 ID: 0.56 (14) End 2 ID: 3.75 (95) Thread Size: M10 X 1.5-6H INT</p>
<p>AF25284M RENAULT V.I. 5010317060 Primary Air Filter used with AF4867, AF820M</p>  <p>Overall Height: 18.73 (476) End 1 OD: 12.09 (307) End 2 OD: 12.07 (307) End 1 ID: 7.74 (197) End 2 ID: 0.67 (17)</p>		



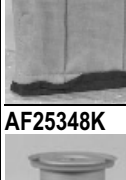



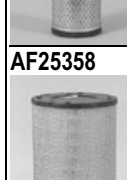







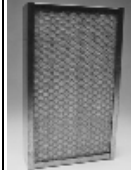





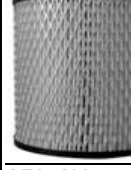

E. PRODUCT GUIDE

<p>AF25303 NEW HOLLAND 82008601, FORD FINISCODE 1869555 Safety Element used with AF25302 Used on Ford 4700K series tractor - Kubota engine</p>  <p>Overall Height: 11.48 (292) End 1 OD: 4.34 (110) End 2 OD: 3.63 (92) End 1 ID: 3.00 (76) End 2 ID: 0.56 (14)</p>	<p>AF25313 SCANIA 1335678 Primary Air Filter used with AF25969 Magnum RS version</p>  <p>Overall Height: 20.65 (525) End 1 OD: 11.87 (302) End 2 OD: 11.93 (303) End 1 ID: 6.69 (170)</p>	<p>AF25322 HATZ 952900</p>  <p>Overall Height: 3.64 (93) Overall OD: 9.65 (245) End 1 ID: 5.63 (143)</p>
<p>AF25304 FORD F4TZ9D695A</p>  <p>Height: 1.26 (32) Length: 4.37 (111) Width: 2.64 (67)</p>	<p>AF25314 SCANIA 1335679 Magnum RS Version</p>  <p>Overall Height: 17.46 (444) End 1 OD: 11.87 (302) End 2 OD: 11.93 (303) End 1 ID: 6.69 (170)</p>	<p>AF25323 MASSEY-FERGUSON 3595500M1 Primary Air Filter used with AF25356</p>  <p>Overall Height: 10.99 (279) Cover Diameter: 8.37 (213) End 2 OD: 6.08 (155) End 2 ID: 3.48 (89) Thread Size: 7/16-20 UNF-2B</p>
<p>AF25305 VOLVO 8143691</p>  <p>Height: 1.93 (49) Length: 8.27 (210) Width: 8.27 (210)</p>	<p>AF25315K FIAT-ALLIS 1930604 Primary Air Filter used with AF4761M</p>  <p>Overall Height: 16.46 (418) Fin Diameter: 11.73 (298) End 2 OD: 9.67 (246) End 1 ID: 6.06 (154) End 2 ID: 0.63 (16)</p>	<p>AF25324K MASSEY-FERGUSON 3515586M1 Primary Air Filter used with AF25356</p>  <p>Overall Height: 11.11 (282) Cover Diameter: 8.37 (213) Fin Diameter: 7.85 (200) End 2 ID: 3.48 (89) Thread Size: 7/16-20 UNF-2B</p>
<p>AF25306 MERCEDES-BENZ 30947504</p>  <p>Height: 2.77 (70) Length: 12.60 (320) Width: 10.95 (278)</p>	<p>AF25316 GMC 25042562</p>  <p>Height: 1.67 (42) Length: 16.00 (406) Width: 7.91 (201)</p>	<p>AF25325 VAPORMATIC CPD7042, FORD E6NN9B618B</p>  <p>Overall Height: 16.58 (421) End 1 OD: 9.01 (229) End 2 OD: 9.00 (229) End 1 ID: 5.71 (145)</p>
<p>AF25307 THERMO-KING 117234</p>  <p>Height: 1.14 (29) Length: 6.02 (153) Width: 7.60 (193)</p>	<p>AF25317 VOLVO 1665937 Safety Element used with AF25238, AF25239, AF25632 On Volvo Model FH12 use AF25238 - On Volvo Model FH16 use AF25239</p>  <p>Overall Height: 17.64 (448) End 1 OD: 7.97 (203) End 2 OD: 7.68 (195) End 1 ID: 6.69 (170)</p>	<p>AF25326 PERLINI 350088A Safety Element used with AF25335</p>  <p>Overall Height: 23.37 (594) End 1 OD: 8.43 (214) End 2 OD: 7.26 (185) End 1 ID: 6.24 (159) End 2 ID: 0.67 (17)</p>
<p>AF25308 TOYOTA 17741U210071 Flame Retardant Media</p>  <p>Overall Height: 12.31 (313) Overall OD: 5.08 (129) End 1 ID: 3.20 (81)</p>	<p>AF25318 KOMATSU 20501K1480 Safety Element used with AF25060KM</p>  <p>Overall Height: 16.42 (417) Overall OD: 4.61 (117) End 1 ID: 3.56 (90) End 2 ID: 0.67 (17)</p>	<p>AF25330 FARR T529DR Filter used with 3349348</p>  <p>Height: 5.25 (133) Length: 29.50 (749) Width: 19.00 (483)</p>
<p>AF25311 J.C.B. 32903201 Primary Air Filter used with AF4882</p>  <p>Overall Height: 11.39 (289) Cover Diameter: 8.37 (213) End 2 OD: 6.08 (155) End 2 ID: 3.48 (89) Thread Size: M10 X 1.5-6H INT</p>	<p>AF25319 MERCEDES-BENZ 30948304</p>  <p>Height: 3.16 (80) Length: 12.60 (320) Width: 10.95 (278)</p>	<p>AF25331 MASSEY-FERGUSON 3385733M1 Primary Air Filter used with AF4994</p>  <p>Overall Height: 13.49 (343) Cover Diameter: 11.02 (280) End 2 OD: 9.21 (234) End 2 ID: 5.00 (127) Thread Size: 7/16-20 UNF-2B</p>
<p>AF25312 VOLVO PENTA 865152</p>  <p>Overall Height: 27.64 (702) End 1 OD: 10.04 (255) End 2 OD: 9.92 (252) End 1 ID: 4.53 (115)</p>	<p>AF25320 VOLKSWAGEN 44129620</p>  <p>Overall Height: 9.33 (237) Overall OD: 6.42 (163) End 1 ID: 3.66 (93)</p>	<p>AF25332 LISTER PETER 60131350</p>  <p>Overall Height: 4.15 (106) Overall OD: 3.66 (93) End 1 ID: 2.21 (56)</p>
	<p>AF25321 MANITOU 177179 Safety Element used with AF4909K</p>  <p>Overall Height: 11.24 (286) End 1 OD: 3.76 (96) End 2 OD: 3.37 (86) End 1 ID: 2.93 (75) End 2 ID: 0.35 (9)</p>	























E. PRODUCT GUIDE

<p>AF25333 RENAULT V.I. 5010230841 Primary Air Filter used with AF25634 Magnum RS Version</p>  <p>Overall Height: 18.25 (464) Overall OD: 12.21 (310) End 1 ID: 7.07 (180)</p>	<p>AF25341 JOHN DEERE AL78869 Primary Air Filter used with AF25334</p>  <p>Overall Height: 12.17 (309) Fin Diameter: 11.22 (285) End 2 OD: 8.80 (224) End 1 ID: 4.86 (124)</p>	<p>AF25349 RENAULT D.M.A. 7701028479 Primary Air Filter used with AF25357</p>  <p>Overall Height: 14.63 (372) End 1 OD: 7.44 (189) End 2 OD: 6.65 (169) End 1 ID: 0.34 (9) End 2 ID: 4.31 (110)</p>
<p>AF25334 JOHN DEERE AL78870 Safety Element used with AF25341</p>  <p>Overall Height: 5.08 (129) Cover Diameter: 9.37 (238) End 2 OD: 6.36 (162) End 1 ID: 4.67 (119)</p>	<p>AF25342 NEW HOLLAND 1930605 Primary Air Filter used with AF25978, AF4165</p>  <p>Overall Height: 13.49 (343) Cover Diameter: 8.37 (213) End 2 OD: 6.08 (155) End 2 ID: 3.48 (89) Thread Size: 7/16-20 UNF-2B</p>	<p>AF25351 FARYMANN 5410612</p>  <p>Overall Height: 6.87 (175) Overall OD: 4.96 (126) End 1 ID: 2.52 (64) End 2 ID: 0.34 (9)</p>
<p>AF25335 PERLINI 350087A Primary Air Filter used with AF25326</p>  <p>Overall Height: 24.54 (623) End 1 OD: 12.08 (307) End 2 OD: 12.06 (306) End 1 ID: 7.73 (196) End 2 ID: 0.67 (17)</p>	<p>AF25343 MASSEY-FERGUSON 1644333M1 Primary Air Filter used with AF25344</p>  <p>Overall Height: 12.44 (316) End 1 OD: 8.98 (228) End 2 OD: 8.31 (211) End 1 ID: 0.39 (10) End 2 ID: 5.30 (135)</p>	<p>AF25352 JOHN DEERE RT6005011111, INGERSOLL-RAND 85400729 Primary Air Filter used with AF25485 Magnum RS Version Outer body is made entirely of flattened expanded metal</p>  <p>Overall Height: 13.78 (350) Overall OD: 6.50 (165) End 1 ID: 3.64 (93)</p>
<p>AF25336 FORD 9846495 Safety Element used with AF25368</p>  <p>Overall Height: 15.01 (381) End 1 OD: 5.97 (152) End 2 OD: 5.96 (151) End 1 ID: 0.67 (17) End 2 ID: 4.85 (123)</p>	<p>AF25344 MASSEY-FERGUSON 1644334M1 Safety Element used with AF25343</p>  <p>Overall Height: 11.46 (291) Overall OD: 5.20 (132) End 1 ID: 4.06 (103) End 2 ID: 0.34 (9)</p>	<p>AF25353 NISSAN 165461G000</p>  <p>Overall Height: 9.23 (235) Overall OD: 4.96 (126) End 1 ID: 2.52 (64) End 2 ID: 0.34 (9)</p>
<p>AF25337M TOYOTA 177432360071, TOYOTA 177412360071 Primary Air Filter used with AF25483 Magnum RS Version</p>  <p>Overall Height: 10.97 (279) Overall OD: 5.43 (138) End 1 ID: 3.29 (84)</p>	<p>AF25345 DONALDSON P527683 Safety Element used with AF25139M Magnum RS Version</p>  <p>Overall Height: 14.45 (367) End 1 OD: 6.89 (175) End 2 OD: 6.75 (172) End 1 ID: 5.28 (134)</p>	<p>AF25354 DONALDSON P536142, DONALDSON P533930 Primary Air Filter used with AF25429 Used in EPG13-0090 Don. Hsg.</p>  <p>Overall Height: 15.46 (393) End 1 OD: 11.11 (282) End 2 OD: 10.96 (278) End 1 ID: 5.87 (149)</p>
<p>AF25338 CATERPILLAR 1236855 Primary Air Filter used with AF25339 Magnum RS version</p>  <p>Overall Height: 15.53 (394) End 1 OD: 14.27 (363) End 2 OD: 14.13 (359) End 1 ID: 8.98 (228)</p>	<p>AF25346 FARR 117780001 Farr RF-180 Series (Baggie Style Air)</p>  <p>Height: 6.38 (162) Length: 29.38 (746) Width: 27.38 (695)</p>	<p>AF25355 MASSEY-FERGUSON 3595501M1 Safety Element used with AF25323, AF25324K</p>  <p>Overall Height: 9.04 (230) End 1 OD: 3.74 (95) End 2 OD: 3.35 (85) End 1 ID: 2.95 (75) End 2 ID: 0.67 (17)</p>
<p>AF25339 CATERPILLAR 1236856 Safety Element used with AF25338</p>  <p>Overall Height: 15.16 (385) End 1 OD: 9.06 (230) End 2 OD: 8.66 (220) End 1 ID: 7.01 (178)</p>	<p>AF25347 FARR 117780002 Farr RF-180 Series (Baggie Style Air)</p>  <p>Height: 5.12 (130) Length: 19.50 (495) Width: 22.12 (562)</p>	<p>AF25357 RENAULT D.M.A. 6005002529 Safety Element used with AF25349, AF25501</p>  <p>Overall Height: 13.07 (332) Overall OD: 4.23 (108) End 1 ID: 3.17 (81) End 2 ID: 0.34 (9)</p>
<p>AF25340 KOHLER 4708303</p>  <p>Overall Height: 2.55 (65) Overall OD: 7.00 (178) End 1 ID: 5.57 (141)</p>	<p>AF25348K FIAT HITACHI 71405431 Primary Air Filter used with AF25978, AF4165</p>  <p>Overall Height: 13.93 (354) Cover Diameter: 8.37 (213) Fin Diameter: 7.85 (200) End 2 ID: 3.48 (89)</p>	<p>AF25358 JOHN DEERE RE34966 Primary Air Filter used with AF25361 Magnum RS version</p>  <p>Overall Height: 15.67 (398) Overall OD: 9.29 (236) End 1 ID: 5.20 (132)</p>

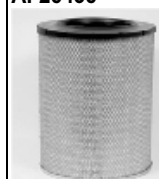















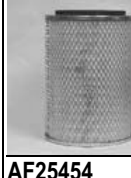
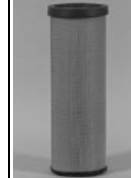







E. PRODUCT GUIDE

AF25359  JOHN DEERE RE51629 Primary Air Filter used with AF25360 Magnum RS Version Overall Height: 15.75 (400) Overall OD: 11.06 (281) End 1 ID: 5.91 (150)	AF25373K  MITSUBISHI MD620109 Overall Height: 6.15 (156) Overall OD: 6.04 (153) End 1 ID: 3.52 (89)	AF25386  KOMATSU 1654674200, NISSAN 1654674200 Overall Height: 5.00 (127) Overall OD: 6.38 (162) End 1 ID: 3.69 (94)
AF25360  JOHN DEERE RE51630 Safety Element used with AF25359 Magnum RS Version Overall Height: 15.04 (382) End 1 OD: 5.93 (151) End 2 OD: 5.59 (142) End 1 ID: 4.11 (105)	AF25374  KOMATSU 4210712312 Height: 2.21 (56) Length: 9.96 (253) Width: 6.00 (153)	AF25392  NISSAN 165460T006 Overall Height: 7.99 (203) End 1 OD: 7.95 (202) End 2 OD: 2.68 (68) End 1 ID: 4.94 (126)
AF25361  JOHN DEERE RE34967 Safety Element used with AF25358 Magnum RS version Overall Height: 14.96 (380) End 1 OD: 5.20 (132) End 2 OD: 4.96 (126) End 1 ID: 3.70 (94)	AF25376  HATZ 40084500 Overall Height: 3.66 (93) Overall OD: 6.50 (165) End 1 ID: 3.50 (89)	AF25398  HINO 178012900 Overall Height: 12.29 (312) Overall OD: 6.33 (161) End 1 ID: 5.22 (133)
AF25365  MITSUBISHI ME073821, CHAMP LAF5783, LUBERFINER LAF5783 Primary Air Filter used with AF25640 Magnum RS Version Overall Height: 16.25 (413) End 1 OD: 9.38 (238) End 2 OD: 9.23 (234) End 1 ID: 5.21 (132)	AF25380  TOYOTA 1780154100 Overall Height: 11.02 (280) Overall OD: 5.28 (134) End 1 ID: 3.05 (78)	AF25399  TOYOTA 1780135030 Overall Height: 5.67 (144) Overall OD: 6.20 (158) End 1 ID: 3.01 (77)
AF25366  NISSAN 1654606J11 Overall Height: 6.04 (154) Overall OD: 6.04 (153) End 1 ID: 3.52 (89)	AF25382  RENAULT V.I. 5010230916 Primary Air Filter used with AF25439 Magnum RS Version Overall Height: 21.77 (553) Overall OD: 12.21 (310) End 1 ID: 7.07 (180)	AF25402  KOMATSU 6001815440 Primary Air Filter used with AF25403 Overall Height: 24.51 (623) End 1 OD: 15.85 (403) End 2 OD: 13.79 (350) End 1 ID: 9.53 (242) End 2 ID: 0.85 (22)
AF25368  NEW HOLLAND 89846494 Primary Air Filter used with AF25336 Overall Height: 16.05 (408) Overall OD: 9.92 (252) End 1 ID: 6.10 (155) End 2 ID: 0.67 (17)	AF25383  NISSAN D6546Z9100 Magnum RS Version Overall Height: 14.68 (373) End 1 OD: 11.30 (287) End 2 OD: 11.15 (283) End 1 ID: 6.87 (175)	AF25403  KOMATSU 6001815450 Safety Element used with AF25402 Overall Height: 22.72 (577) Overall OD: 8.59 (218) End 1 ID: 7.15 (182) End 2 ID: 0.68 (17)
AF25371  NEW HOLLAND 82008606 Primary Air Filter used with AF25457 Overall Height: 15.55 (395) End 1 OD: 9.09 (231) End 2 OD: 8.35 (212) End 1 ID: 0.45 (12) End 2 ID: 4.84 (123)	AF25384  HITACHI 4283861 Primary Air Filter used with AF25413 Overall Height: 14.51 (368) End 1 OD: 8.21 (209) End 2 OD: 8.00 (203) End 1 ID: 4.87 (124)	AF25408  MITSUBISHI ME073252 Overall Height: 17.65 (448) Overall OD: 9.13 (232) End 1 ID: 5.83 (148) End 2 ID: .88 (22)
AF25372  ISUZU 8943349060 Overall Height: 5.87 (149) Overall OD: 5.98 (152) End 1 ID: 3.49 (89)	AF25385K  DAIHATSU 1780187304 Overall Height: 8.11 (206) End 1 OD: 6.03 (153) End 2 OD: 6.02 (153) End 1 ID: 3.51 (89)	AF25409M  Rogers Machinery Gen Set Overall Height: 12.67 (322) Overall OD: 13.83 (351) End 1 ID: 9.48 (241) End 2 ID: 0.90 (23)



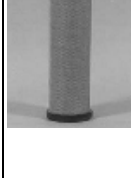



















E. PRODUCT GUIDE

<p>AF25410M TORIT 8PP2537000 Flame retardant media</p>  <p>Overall Height: 22.50 (572) Overall OD: 13.83 (351) End 1 ID: 9.48 (241)</p>	<p>AF25418 HITACHI 4285623</p>  <p>Overall Height: 12.92 (328) End 1 OD: 6.06 (154) End 2 OD: 3.18 (81) End 1 ID: 4.19 (106) End 2 ID: 5.98 (152)</p>	<p>AF25429 DONALDSON P533890 Safety Element used with AF25354 Used in EPG13-0077 Donaldson Housing.</p>  <p>Overall Height: 14.84 (377) End 1 OD: 5.94 (151) End 2 OD: 5.60 (142) End 1 ID: 5.05 (128)</p>
<p>AF25411M TORIT 8PP4205800 Flame retardant media</p>  <p>Overall Height: 26.50 (673) Overall OD: 13.83 (351) End 1 ID: 9.48 (241)</p>	<p>AF25419 HITACHI 4247975</p>  <p>Overall Height: 11.58 (294) End 1 OD: 3.10 (79) End 2 OD: 3.93 (100) End 1 ID: 4.02 (102) End 2 ID: 2.95 (75)</p>	<p>AF25430 Safety Element used with AF25033M</p>  <p>Overall Height: 17.76 (451) End 1 OD: 6.89 (175) End 2 OD: 6.52 (166) End 1 ID: 5.89 (150)</p>
<p>AF25412 DONALDSON P821963 Safety Element used with AF25414</p>  <p>Overall Height: 13.65 (347) End 1 OD: 5.30 (135) End 2 OD: 4.98 (126) End 1 ID: 4.43 (113)</p>	<p>AF25423 FORD F5UZ9601A</p>  <p>Height: 1.58 (40) Length: 11.19 (284) Width: 6.50 (165)</p>	<p>AF25432K TOYOTA 178072380071 Primary Air Filter used with AF4744</p>  <p>Overall Height: 11.54 (293) Cover Diameter: 7.76 (197) Fin Diameter: 6.34 (161) End 1 ID: 0.47 (12) End 2 ID: 3.35 (85)</p>
<p>AF25413 HITACHI 4287060 Safety Element used with AF25384</p>  <p>Overall Height: 13.78 (350) Overall OD: 4.95 (126) End 1 ID: 4.10 (104)</p>	<p>AF25424 KHD(KLOCKNER-HUMBOLDT-DEUTZ) 2243521 Safety Element used with AF4137, AF4637, AF990</p>  <p>Overall Height: 7.52 (191) End 1 OD: 3.31 (84) End 2 OD: 3.23 (82) End 1 ID: 2.87 (73) End 2 ID: 0.34 (9)</p>	<p>AF25433 FARYMANN 5410522</p>  <p>Overall Height: 5.35 (136) Overall OD: 3.90 (99) End 1 ID: 1.44 (37)</p>
<p>AF25414 HITACHI 4286128 Primary Air Filter used with AF25412</p>  <p>Overall Height: 14.45 (367) End 1 OD: 9.38 (238) End 2 OD: 9.23 (234) End 1 ID: 5.21 (132)</p>	<p>AF25425 KHD(KLOCKNER-HUMBOLDT-DEUTZ) 2243522 Safety Element used with AF991</p>  <p>Overall Height: 12.24 (311) End 1 OD: 3.31 (84) End 2 OD: 3.23 (82) End 1 ID: 2.87 (73) End 2 ID: 0.34 (9)</p>	<p>AF25434 FIATAGRI 1930592 Safety Element used with AF25290, AF25539</p>  <p>Overall Height: 11.28 (287) End 1 OD: 2.36 (60) End 2 OD: 2.24 (57) End 1 ID: 1.65 (42)</p>
<p>AF25415 HINO 178012810</p>  <p>Overall Height: 18.49 (470) Overall OD: 9.21 (234) End 1 ID: 4.86 (123) End 2 ID: 0.67 (17)</p>	<p>AF25426 DAF 1317409 Magnum RS Version</p>  <p>Overall Height: 19.04 (484) Overall OD: 11.06 (281) End 1 ID: 5.91 (150)</p>	<p>AF25435 VOLVO 8076195</p>  <p>Gasket: 256464 (1) Overall Height: 16.50 (419) Overall OD: 13.09 (332) End 1 ID: 7.69 (195)</p>
<p>AF25416 HINO 178013000 Primary Air Filter used with AF25638</p>  <p>Overall Height: 13.61 (346) End 1 OD: 9.38 (238) End 2 OD: 9.23 (234) End 1 ID: 5.89 (150) End 2 ID: 5.21 (132)</p>	<p>AF25427 MERCEDES-BENZ 30949104</p>  <p>Overall Height: 12.53 (318) End 1 OD: 16.54 (420) End 2 OD: 16.52 (420) End 1 ID: 10.02 (255) End 2 ID: 0.41 (11)</p>	<p>AF25436 FIAT HITACHI 4290940 Primary Air Filter used with AF25497 Magnum RS version</p>  <p>Overall Height: 12.30 (313) Overall OD: 4.96 (126) End 1 ID: 3.21 (82)</p>
<p>AF25417 HITACHI 4206099</p>  <p>Overall Height: 12.35 (314) Overall OD: 6.08 (154) End 1 ID: 4.06 (103) End 2 ID: 0.65 (17)</p>	<p>AF25428 MERCEDES-BENZ 30949204</p>  <p>Overall Height: 10.30 (262) End 1 OD: 16.54 (420) End 2 OD: 16.52 (420) End 1 ID: 10.02 (255) End 2 ID: 0.41 (11)</p>	<p>AF25437 DAF 1295090, INGERSOLL-RAND 85400737 Primary Air Filter used with AF25523 Magnum RS version</p>  <p>Overall Height: 20.65 (525) Overall OD: 11.06 (281) End 1 ID: 5.91 (150)</p>

E. PRODUCT GUIDE

AF25438  MITSUBISHI ME017242 Magnum RS Version Overall Height: 9.69 (246) Overall OD: 7.09 (180) End 1 ID: 3.70 (94)	AF25450  HINO 178012910, HINO 178012830 Overall Height: 14.45 (367) Overall OD: 10.91 (277) End 1 ID: 6.50 (165)	AF25466M  STEIGER 908300T1 Primary Air Filter used with AF25467M Magnum RS Version Overall Height: 21.45 (545) End 1 OD: 12.53 (318) End 2 OD: 12.37 (314) End 1 ID: 8.20 (208)
AF25439  RENAULT V.I. 5010269584 Safety Element used with AF25382 Magnum RS version Overall Height: 21.06 (535) End 1 OD: 7.05 (179) End 2 OD: 6.81 (173) End 1 ID: 5.39 (137)	AF25450M  DONALDSON P830524 Overall Height: 14.31 (364) End 1 OD: 10.57 (268) End 2 OD: 6.02 (153) End 1 ID: 6.47 (164) End 2 ID: 0.90 (23)	AF25467M  CASE 908301T1 Safety Element used with AF25466M Magnum RS Version Overall Height: 20.75 (527) End 1 OD: 8.27 (210) End 2 OD: 7.84 (199) End 1 ID: 6.14 (156)
AF25440K  KUBOTA 1497111180 Overall Height: 4.02 (102) End 1 OD: 4.17 (106) End 2 OD: 3.37 (86) End 1 ID: 1.24 (32) End 2 ID: 1.22 (31)	AF25451  HINO 178012820, HINO 178012730 Overall Height: 13.39 (340) Overall OD: 9.06 (230) End 1 ID: 4.76 (121)	AF25468  TEREX 15270189 Safety Element used with AF25454, AF25627 Overall Height: 20.04 (509) End 1 OD: 7.05 (179) End 2 OD: 6.81 (173) End 1 ID: 5.39 (137)
AF25441  HITACHI 4285619 Overall Height: 10.94 (278) End 1 OD: 5.23 (133) End 2 OD: 7.91 (201) End 1 ID: 5.37 (136) End 2 ID: 7.83 (199)	AF25454  INGERSOLL-RAND 85401339 Primary Air Filter used with AF25468 Terex 15270188 - Magnum RS Version - Overall Height: 20.63 (524) Overall OD: 12.21 (310) End 1 ID: 7.07 (180)	AF25469  DONALDSON P533938 Primary Air Filter used with AF25470 Magnum RS Version Overall Height: 17.23 (438) Overall OD: 13.50 (343) End 1 ID: 8.20 (208)
AF25442  MITSUBISHI 9126106700 Overall Height: 9.19 (233) Fin OD: 5.16 (131) End 1 OD: 4.20 (107) End 1 ID: .64 (16) End 2 ID: 2.17 (55)	AF25456K  CASE 1265510C1 Overall Height: 11.50 (292) Fin Diameter: 6.41 (163) End 2 OD: 5.25 (133) End 1 ID: 3.25 (83) End 2 ID: 0.66 (17)	AF25470  DONALDSON P533946 Safety Element used with AF25469 Magnum RS Version Overall Height: 16.84 (428) End 1 OD: 8.32 (211) End 2 OD: 7.89 (200) End 1 ID: 6.12 (155)
AF25443  KOMATSU 6001816340 Overall Height: 10.20 (259) End 1 OD: 3.01 (76) End 2 OD: 4.96 (126) End 1 ID: 3.05 (77) End 2 ID: 5.07 (129)	AF25457  NEW HOLLAND 82008607 Safety Element used with AF25371 Overall Height: 13.92 (354) End 1 OD: 5.98 (152) End 2 OD: 4.72 (120) End 1 ID: 3.94 (100) End 2 ID: 0.43 (11)	AF25471  HONDA 17210ZE0505, HONDA 17210ZE0822 Overall Height: 2.01 (51) End 1 ID: 0.87 (22)
AF25444  KOMATSU 6001819470 No wing nut included Overall Height: 12.43 (316) End 1 OD: 3.12 (79) End 2 OD: 5.96 (151) End 1 ID: 3.56 (90) End 2 ID: 5.97 (152)	AF25460M  CASE 132151A1 Primary Air Filter used with AF25461M Magnum RS Version Overall Height: 21.50 (546) End 1 OD: 11.11 (282) End 2 OD: 10.98 (279) End 1 ID: 5.87 (149)	AF25472  HONDA 17210ZB1822, HONDA 17210ZE1505 Overall Height: 2.76 (70) End 1 ID: 0.87 (22)
AF25446  NISSAN 1654665000 Overall Height: 2.68 (68) Overall OD: 14.33 (364) End 1 ID: 11.73 (298) End 2 ID: 11.73 (298)	AF25461M  CASE 132149A1 Safety Element used with AF25460M Magnum RS Version Overall Height: 20.75 (527) End 1 OD: 5.93 (151) End 2 OD: 5.59 (142) End 1 ID: 4.11 (105)	AF25473  HONDA 17210ZE2505, HONDA 17210ZE2822 Overall Height: 3.07 (78) End 1 ID: 0.87 (22)
AF25447  MITSUBISHI MD604940 Overall Height: 2.65 (67) Overall OD: 10.53 (267) End 1 ID: 7.80 (198) End 2 ID: 7.35 (187)		AF25474  HONDA 17210ZE3822, HONDA 17210ZE3505 Overall Height: 3.58 (91) End 1 ID: 0.87 (22)

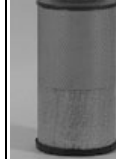

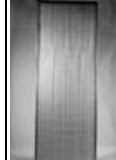





















E. PRODUCT GUIDE

<p>AF25475 HINO 178012410</p>  <p>Overall Height: 9.29 (236) Overall OD: 7.48 (190) End 1 ID: 4.13 (105)</p>	<p>AF25484 FIATAGRI 1930588 Safety Element used with AF25291, AF25526, AF25588 Magnum RS Version</p>  <p>Overall Height: 12.50 (318) End 1 OD: 3.31 (84) End 2 OD: 3.07 (78) End 1 ID: 2.48 (63)</p>	<p>AF25498 NEW HOLLAND 82008596 Primary Air Filter used with AF25499</p>  <p>Overall Height: 12.36 (314) End 1 OD: 9.13 (232) End 2 OD: 8.35 (212) End 1 ID: 0.45 (12) End 2 ID: 4.84 (123)</p>
<p>AF25476 MERCEDES-BENZ 40940204 Primary Air-Magnum RS Version</p>  <p>Overall Height: 16.12 (410) End 1 OD: 13.58 (345) End 2 OD: 10.98 (279) End 2 ID: 4.92 (125)</p>	<p>AF25485 INGERSOLL-RAND 59046805, FIATAGRI 1930590 Safety Element used with AF25292, AF25352 Magnum RS version</p>  <p>Overall Height: 13.29 (338) End 1 OD: 3.66 (93) End 2 OD: 3.43 (87) End 1 ID: 2.84 (72)</p>	<p>AF25499 NEW HOLLAND 82008597 Safety Element used with AF25498</p>  <p>Overall Height: 10.81 (275) End 1 OD: 5.98 (152) End 2 OD: 4.72 (120) End 1 ID: 3.94 (100) End 2 ID: 0.43 (11)</p>
<p>AF25477 MITSUBISHI 9136113300</p>  <p>Overall Height: 8.92 (227) End 1 OD: 2.36 (60) End 2 OD: 4.26 (108) End 1 ID: 2.46 (63) End 2 ID: 4.19 (106)</p>	<p>AF25490 KHD(KLOCKNER-HUMBOLDT-DEUTZ) 4308634 Safety Element used with AF4137</p>  <p>Overall Height: 7.85 (200) End 1 OD: 3.15 (80) End 2 OD: 2.64 (67) End 1 ID: 2.28 (58) End 2 ID: 0.35 (9)</p>	<p>AF25500K MITSUBISHI MD620563</p>  <p>Overall Height: 7.89 (201) Fin Diameter: 7.85 (200) End 2 OD: 6.08 (154) End 1 ID: 3.48 (88) End 2 ID: 0.47 (12)</p>
<p>AF25478 LEYLAND ACHD040 Magnum RS Version</p>  <p>Overall Height: 20.91 (531) Overall OD: 8.19 (208) End 1 ID: 4.17 (106)</p>	<p>AF25491 J.C.B. 32912902 Safety Element used with AF25492, AF25964 Magnum RS version</p>  <p>Overall Height: 15.93 (405) End 1 OD: 4.29 (109) End 2 OD: 4.06 (103) End 1 ID: 3.47 (88)</p>	<p>AF25501 VALMET 836136409 Primary Air Filter used with AF25357</p>  <p>Overall Height: 13.70 (348) Cover Diameter: 7.76 (197) End 2 OD: 6.44 (164) End 1 ID: 0.34 (9) End 2 ID: 4.63 (118)</p>
<p>AF25479 VAN HOOL 10591354 Primary Air Filter used with AF25620</p>  <p>Overall Height: 22.95 (583) Overall OD: 12.21 (310) End 1 ID: 7.07 (180)</p>	<p>AF25492 J.C.B. 32912901, INGERSOLL-RAND 85400752 Primary Air Filter used with AF25491 Magnum RS Version</p>  <p>Overall Height: 16.58 (421) Overall OD: 8.19 (208) End 1 ID: 4.17 (106)</p>	<p>AF25502K SAME 242493401 Primary Air Filter used with AF25503</p>  <p>Overall Height: 12.85 (327) Cover Diameter: 6.73 (171) Fin Diameter: 6.26 (159) End 2 ID: 3.17 (81) Thread Size: 7/16-20 UNF-2B</p>
<p>AF25480 VORTOX VF120W</p>  <p>Overall Height: 19.05 (484) Overall OD: 10.98 (279) End 1 ID: 5.80 (147)</p>	<p>AF25493 TOYOTA 278011506083</p>  <p>Overall Height: 1.50 (38) Overall OD: 9.84 (250) End 1 ID: 2.56 (65)</p>	<p>AF25503 SAME 242493402 Safety Element used with AF25502K</p>  <p>Overall Height: 11.14 (283) End 1 OD: 3.66 (93) End 2 OD: 2.01 (51) End 1 ID: 2.42 (62) End 2 ID: 0.65 (17)</p>
<p>AF25481 HATZ 4030100</p>  <p>Overall Height: 3.31 (84) Overall OD: 5.53 (141) End 1 ID: 3.13 (80)</p>	<p>AF25496 M.A.N. 81083040087, M.A.N. 81084050015 Magnum RS version</p>  <p>Overall Height: 15.04 (382) Overall OD: 9.76 (248) End 1 ID: 4.72 (120)</p>	<p>AF25504 RENAULT AGRICULTURE 7700039509 Primary Air Filter used with AF25755 Magnum RS Version</p>  <p>Overall Height: 15.04 (382) Overall OD: 8.19 (208) End 1 ID: 4.17 (106)</p>
<p>AF25483 TOYOTA 177442360071 Safety Element used with AF25337M Magnum RS Version</p>  <p>Overall Height: 10.41 (265) End 1 OD: 3.31 (84) End 2 OD: 3.07 (78) End 1 ID: 2.48 (63)</p>	<p>AF25497 CATERPILLAR 1402337, BOBCAT 6666334 Safety Element used with AF25436 Magnum RS version</p>  <p>Overall Height: 11.63 (296) End 1 OD: 3.31 (84) End 2 OD: 3.07 (78) End 1 ID: 2.48 (63)</p>	<p>AF25506 FARR 55445011</p>  <p>Height: 5.30 (135) Length: 36.44 (926) Width: 14.00 (356)</p>



























E. PRODUCT GUIDE

<p>AF25507 CLARK AK2</p>  <p>Overall Height: 12.15 (309) Overall OD: 8.00 (203) End 1 ID: 6.13 (156)</p>	<p>AF25523 Safety Element used with AF25437, AF25756 John Deere 644H Wheel Loader.</p>  <p>Overall Height: 19.72 (501) End 1 OD: 5.93 (151) End 2 OD: 5.59 (142) End 1 ID: 4.11 (105)</p>	<p>AF25538 MASSEY-FERGUSON 6191362M1 Primary Air Filter used with AF25967 Magnum RS</p>  <p>Overall Height: 7.28 (185) Overall OD: 3.54 (90) End 1 ID: 1.81 (46)</p>
<p>AF25508 MIDLAND STEEL 100696E</p>  <p>Overall Height: 1.25 (32) Overall OD: 4.00 (102) End 1 ID: 1.88 (48)</p>	<p>AF25524 CASE 128781A1 Primary Air Filter used with AF25521</p>  <p>Overall Height: 15.43 (392) Overall OD: 5.43 (138) End 1 ID: 3.29 (84)</p>	<p>AF25539 ATLAS 2911788, INGERSOLL-RAND 85400646 Primary Air Filter used with AF25434 Magnum RS Version</p>  <p>Overall Height: 11.81 (300) Overall OD: 4.11 (105) End 1 ID: 2.38 (61)</p>
<p>AF25509K J.C.B. 32906801 Primary Air Filter used with AF4882 Is a short version of AF4892K</p>  <p>Overall Height: 11.39 (289) Cover Diameter: 8.37 (213) Fin Diameter: 7.85 (200) End 2 ID: 3.48 (89) Thread Size: M10 X 1.5-6H</p>	<p>AF25525 Is a short version of AF25952M Similar to AF25219 with Hot Melt on Outside Only</p>  <p>Overall Height: 23.66 (601) End 1 OD: 9.38 (238) End 2 OD: 9.23 (234) End 1 ID: 5.87 (149)</p>	<p>AF25540K J.C.B. 32905001 Primary Air Filter used with AF25529</p>  <p>Overall Height: 8.47 (215) Cover Diameter: 7.05 (179) Fin Diameter: 6.34 (161) End 2 ID: 2.82 (72) Thread Size: M10 X 1.5-6H INT</p>
<p>AF25510 TOYOTA 1780154170</p>  <p>Overall Height: 4.64 (118) Overall OD: 8.48 (215) End 1 ID: 4.25 (108)</p>	<p>AF25526 ATLAS 2991546, INGERSOLL-RAND 85400679 Primary Air Filter used with AF25484 Magnum RS type</p>  <p>Overall Height: 12.78 (325) Overall OD: 5.59 (142) End 1 ID: 3.25 (83)</p>	<p>AF25541 CHRYSLER 4864442</p>  <p>Height: 2.86 (73) Length: 11.81 (300) Width: 10.75 (273)</p>
<p>AF25517 GENERAL ELECTRIC 1X6383</p>  <p>Overall Height: 7.88 (200) Overall OD: 5.56 (141) End 1 ID: 2.75 (70)</p>	<p>AF25527 J.C.B. 32905302 Safety Element used with AF25528K, WGA473K</p>  <p>Overall Height: 7.05 (179) End 1 OD: 2.76 (70) End 2 OD: 2.40 (61) End 1 ID: 2.01 (51) End 2 ID: 0.67 (17)</p>	<p>AF25542 FRANKLIN 1504918, FRAM CA2551SY, BALDWIN PA2607 Safety Element used with AF4767</p>  <p>Overall Height: 12.50 (318) Overall OD: 5.56 (141) End 1 ID: 4.50 (114) End 2 ID: 0.42 (11)</p>
<p>AF25519 INGERSOLL-RAND 59144188</p>  <p>Overall Height: 11.74 (298) Overall OD: 3.32 (84) End 1 ID: 2.55 (65)</p>	<p>AF25528K J.C.B. 32905301 Primary Air Filter used with AF25527</p>  <p>Overall Height: 8.39 (213) Cover Diameter: 5.59 (142) Fin Diameter: 5.16 (131) End 2 ID: 2.48 (63)</p>	<p>AF25543K Filter used with AH19108</p>  <p>Overall Height: 10.38 (264) Fin Diameter: 5.17 (131) End 2 OD: 4.09 (104) End 1 ID: 2.47 (63) End 2 ID: 0.66 (17)</p>
<p>AF25521 CASE 128782A1 Safety Element used with AF25524 Magnum RS type</p>  <p>Overall Height: 14.86 (378) End 1 OD: 3.31 (84) End 2 OD: 3.07 (78) End 1 ID: 2.48 (63)</p>	<p>AF25529 J.C.B. 32905002 Safety Element used with AF25540K</p>  <p>Overall Height: 7.01 (178) End 1 OD: 3.64 (93) End 2 OD: 2.74 (70) End 1 ID: 2.42 (62) End 2 ID: 0.67 (17)</p>	<p>AF25544 Primary Air Filter used with AF25545 Filter used with AH19075, AH19076</p>  <p>Overall Height: 24.50 (622) Overall OD: 15.12 (384) End 1 ID: 10.00 (254)</p>
<p>AF25522 KASSBOHRER 8319147187</p>  <p>Overall Height: 18.50 (470) End 1 OD: 11.87 (302) End 2 OD: 11.93 (303) End 1 ID: 6.69 (170)</p>	<p>AF25530 LISTER PETTER 36607188</p>  <p>Overall Height: 2.91 (74) Overall OD: 5.95 (151) End 1 ID: 3.47 (88)</p>	<p>AF25545 Safety Element used with AF25544 Filter used with AH19076</p>  <p>Overall Height: 23.50 (597) Overall OD: 9.89 (251) End 1 ID: 8.05 (204)</p>
		<p>AF25546 Filter used with AH19077</p>  <p>Overall Height: 15.50 (394) End 1 OD: 7.00 (178) End 2 OD: 5.98 (152) End 1 ID: 3.62 (92)</p>













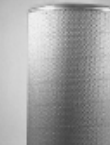



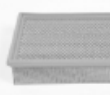











E. PRODUCT GUIDE

<p>AF25547 Filter used with AH19078</p>  <p>Overall Height: 18.50 (470) End 1 OD: 8.25 (210) End 2 OD: 7.20 (183) End 1 ID: 4.75 (121)</p>	<p>AF25555 Primary Air Filter used with AF25556 Filter used with AH19091, AH19092, AH19093, AH19094</p>  <p>Overall Height: 13.00 (330) End 1 OD: 5.41 (137) End 2 OD: 5.39 (137) End 2 ID: 3.32 (84)</p>	<p>AF25569 TOYOTA 1780123020 Outside/in flow</p>  <p>Overall Height: 4.13 (105) Overall OD: 6.42 (163) End 1 ID: 2.99 (76)</p>
<p>AF25548 Filter used with AH19079</p>  <p>Overall Height: 19.50 (495) End 1 OD: 9.85 (250) End 2 OD: 7.94 (202) End 1 ID: 6.05 (154)</p>	<p>AF25556 Safety Element used with AF25555 Filter used with AH19092, AH19094</p>  <p>Overall Height: 12.60 (320) End 1 OD: 3.32 (84) End 2 OD: 2.99 (76) End 1 ID: 2.59 (66)</p>	<p>AF25570 JOHN DEERE RE46310 Primary Air Filter used with AF25571</p>  <p>Overall Height: 16.83 (427) End 1 OD: 9.21 (234) End 2 OD: 9.14 (232) End 1 ID: 0.67 (17) End 2 ID: 5.87 (149)</p>
<p>AF25549 Filter used with AH19080</p>  <p>Overall Height: 19.50 (495) End 1 OD: 11.46 (291) End 2 OD: 10.39 (264) End 1 ID: 7.00 (178)</p>	<p>AF25557 Primary Air Filter used with AF25558 Filter used with AH19095, AH19096, AH19097, AH19098</p>  <p>Overall Height: 13.99 (355) Overall OD: 6.42 (163) End 1 ID: 3.74 (95)</p>	<p>AF25571 JOHN DEERE RE46311 Safety Element used with AF25570</p>  <p>Overall Height: 15.15 (385) End 1 OD: 0.65 (17) End 2 OD: 5.56 (141) End 1 ID: 4.41 (112) End 2 ID: 5.56 (141)</p>
<p>AF25550 Filter used with AH19081, AH19082</p>  <p>Overall Height: 7.33 (186) Overall OD: 3.50 (89) End 1 ID: 1.87 (48)</p>	<p>AF25558 OMNIQUIP PARTS WORLDWIDE 8035099, INGERSOLL-RAND 59155127 Safety Element used with AF25557 Filter used with AH19096, AH19098</p>  <p>Overall Height: 13.16 (334) End 1 ID: 2.75 (70)</p>	<p>AF25573 HITACHI 4234793</p>  <p>Length: 8.88 (225) Width: 10.75 (273)</p>
<p>AF25551 Primary Air Filter used with AF25552 Filter used with AH19083, AH19084, AH19085, AH19086</p>  <p>Overall Height: 10.80 (274) Overall OD: 4.13 (105) End 2 ID: 2.50 (64)</p>	<p>AF25561 NISSAN 1654629101</p>  <p>Overall Height: 13.85 (352) End 1 OD: 6.75 (171) End 2 OD: 7.68 (195) End 1 ID: 4.99 (127)</p>	<p>AF25574 NEW HOLLAND 81868102</p>  <p>Height: 1.97 (50) Length: 4.09 (104) Width: 20.45 (520)</p>
<p>AF25552 Safety Element used with AF25551 Filter used with AH19084, AH19086</p>  <p>Overall Height: 10.35 (263) Overall OD: 2.39 (61) End 1 ID: 1.81 (46)</p>	<p>AF25565 COMPAIR 9826251261 Primary Air Filter used with AF25566</p>  <p>Overall Height: 14.19 (361) End 1 OD: 5.87 (149) End 2 OD: 5.83 (148) End 2 ID: 3.31 (84)</p>	<p>AF25575 BOBCAT 6672467 Primary Air Filter used with AF25576 Magnum RS</p>  <p>Overall Height: 10.63 (270) Overall OD: 4.11 (105) End 1 ID: 2.38 (61)</p>
<p>AF25553 Primary Air Filter used with AF25554 Filter used with AH19087, AH19088, AH19089, AH19090</p>  <p>Overall Height: 12.39 (315) End 1 OD: 5.13 (130) End 2 OD: 5.10 (130) End 1 ID: 3.32 (84)</p>	<p>AF25566 COMPAIR 9826251262 Safety Element used with AF25565</p>  <p>Overall Height: 13.47 (342) End 1 OD: 3.03 (77) End 2 OD: 2.93 (75) End 1 ID: 2.52 (64)</p>	<p>AF25576 BOBCAT 6672468 Safety Element used with AF25575 Safety RS</p>  <p>Overall Height: 10.45 (266) End 1 OD: 2.36 (60) End 2 OD: 2.24 (57) End 1 ID: 1.65 (42)</p>
<p>AF25554 Safety Element used with AF25553 Filter used with AH19088, AH19090</p>  <p>Overall Height: 11.87 (302) End 1 OD: 3.32 (84) End 2 OD: 2.99 (76) End 1 ID: 2.59 (66)</p>	<p>AF25567 TOYOTA 1780162010</p>  <p>Overall Height: 5.66 (144) Overall OD: 7.72 (196) End 1 ID: 3.35 (85)</p>	<p>AF25578M KUBOTA T00716323</p>  <p>Overall Height: 9.75 (248) Overall OD: 4.00 (102) End 1 ID: 2.50 (64)</p>
		<p>AF25579KM DONALDSON P900735</p> 





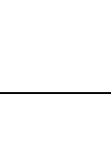
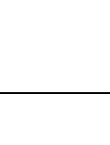







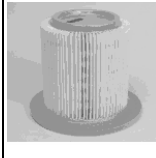

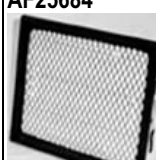







E. PRODUCT GUIDE

<p>AF25580KM DONALDSON P533597 Primary Air Filter used with AF25676</p>  <p>Overall Height: 8.38 (213) Fin Diameter: 5.17 (131) End 2 OD: 4.09 (104) End 1 ID: 2.56 (65) End 2 ID: 0.66 (17)</p>	<p>AF25596M Safety Element used with AF25595</p>  <p>Overall Height: 21.50 (546) End 1 OD: 6.89 (175) End 2 OD: 6.75 (172) End 1 ID: 5.28 (134)</p>	<p>AF25614 SCANIA 1387549</p>  <p>Overall Height: 17.46 (444) Overall OD: 12.21 (310) End 1 ID: 7.07 (180)</p>
<p>AF25582M MITSUBISHI AE073385</p>  <p>Overall Height: 16.42 (417) Overall OD: 5.61 (142) End 1 ID: 0.64 (16) End 2 ID: 4.72 (120)</p>	<p>AF25598 DONALDSON P542101</p>  <p>Overall Height: 15.37 (390) End 1 OD: 10.96 (278) End 2 OD: 10.81 (274) End 1 ID: 6.78 (172)</p>	<p>AF25615 M.A.N. 81083040084 Safety Element used with AF25264</p>  <p>Overall Height: 18.50 (470) End 1 OD: 6.68 (170) End 2 OD: 6.44 (164) End 1 ID: 5.22 (133)</p>
<p>AF25584M TOYOTA 1780167060</p>  <p>Overall Height: 5.66 (144) Overall OD: 4.23 (107) End 1 ID: 8.56 (217)</p>	<p>AF25599 ROVER ESR1445</p>  <p>Height: 2.22 (56) Length: 10.14 (258) Width: 7.92 (201)</p>	<p>AF25616 SEDDON-ATKINSON 3308730R1</p>  <p>Overall Height: 18.49 (470) Overall OD: 12.08 (307) End 1 ID: 7.72 (196) End 2 ID: 0.67 (17)</p>
<p>AF25588 CLARK 6666375 Primary Air Filter used with AF25484</p>  <p>Overall Height: 12.99 (330) Overall OD: 5.43 (138) End 1 ID: 3.29 (84)</p>	<p>AF25601 CHRYSLER MD620048</p>  <p>Overall Height: 3.04 (77) Overall OD: 9.20 (234) End 1 ID: 6.63 (168)</p>	<p>AF25617 CASE 187471A1 Primary Air Filter used with AF25618</p>  <p>Overall Height: 15.53 (395) Overall OD: 8.19 (208) End 1 ID: 4.17 (106)</p>
<p>AF25589 CATERPILLAR 1318822 Primary Air Filter used with AF25624 Magnum RS</p>  <p>Overall Height: 13.47 (342) Overall OD: 9.29 (236) End 1 ID: 5.20 (132)</p>	<p>AF25602 MITSUBISHI ME294850</p>  <p>Overall Height: 14.90 (378) Overall OD: 11.00 (279) End 1 ID: 5.73 (146)</p>	<p>AF25618 CASE 187472A2 Safety Element used with AF25617, AF25957 Magnum RS Version</p>  <p>Overall Height: 14.94 (380) End 1 OD: 4.29 (109) End 2 OD: 4.06 (103) End 1 ID: 3.47 (88)</p>
<p>AF25590 MOTORCRAFT FA1634</p>  <p>Overall Height: 7.81 (198) Overall OD: 8.13 (207) End 1 ID: 4.26 (108)</p>	<p>AF25607 YANMAR 11425012580</p>  <p>Overall Height: 1.79 (46) End 1 OD: 4.13 (105) End 2 OD: 3.94 (100) End 1 ID: 2.05 (52) End 2 ID: 0.24 (6)</p>	<p>AF25619 VOLVO CONSTRUCTION EQUIPMENT 11033998 Primary Air Filter used with AF25620</p>  <p>Overall Height: 22.95 (583) Overall OD: 12.21 (310) End 1 ID: 7.07 (180)</p>
<p>AF25591 INGERSOLL-RAND 59155143, INGERSOLL-RAND 5915543</p>  <p>Overall Height: 15.43 (392) Overall OD: 6.09 (155) End 1 ID: 3.48 (88) End 2 ID: 0.66 (17)</p>	<p>AF25608 HONDA 17220PE0663</p>  <p>Overall Height: 1.69 (43) Overall OD: 10.43 (265) End 2 ID: 7.76 (197)</p>	<p>AF25620 VOLVO CONSTRUCTION EQUIPMENT 110339991 Safety Element used with AF25619, AF25479 Magnum RS Version</p>  <p>Overall Height: 22.17 (563) End 1 OD: 7.05 (179) End 2 OD: 6.81 (173) End 1 ID: 5.39 (137)</p>
<p>AF25593 NELSON 64288P Filter used with AH19115</p>  <p>Overall Height: 23.73 (603) Cover Diameter: 16.30 (414) End 2 OD: 12.08 (307) End 2 ID: 7.73 (196)</p>	<p>AF25610 DYNAPAC 909271 Safety Element used with AF25612</p>  <p>Overall Height: 19.82 (504) End 1 OD: 4.29 (109) End 2 OD: 4.06 (103) End 1 ID: 3.47 (88)</p>	<p>AF25621 MOTORCRAFT FA1675 Has foam precleaner</p>  <p>Height: 2.32 (59) Length: 13.48 (342) Width: 7.09 (180)</p>
<p>AF25595 CASE 243968A1 Primary Air Filter used with AF25596M</p>  <p>Overall Height: 22.20 (564) End 1 OD: 13.05 (331) End 2 OD: 12.90 (328) End 1 ID: 6.78 (172)</p>	<p>AF25612 DYNAPAC 909270 Primary Air Filter used with AF25610</p>  <p>Overall Height: 20.59 (523) Overall OD: 8.19 (208) End 1 ID: 4.17 (106)</p>	<p>AF25623 DAF 1353115 Magnum RS Version Flame Retardant Media</p>  <p>Overall Height: 19.96 (507) Overall OD: 11.06 (281) End 1 ID: 5.91 (150)</p>





















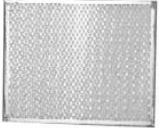





E. PRODUCT GUIDE

<p>AF25624 CATERPILLAR 1318821 Safety Element used with AF25589</p>  <p>Overall Height: 12.72 (323) End 1 OD: 5.20 (132) End 2 OD: 4.96 (126) End 1 ID: 3.70 (94)</p>	<p>AF25634 RENAULT V.I. 5010317187 Safety Element used with AF25333</p>  <p>Overall Height: 17.52 (445) End 1 OD: 7.05 (179) End 2 OD: 6.81 (173) End 1 ID: 5.39 (137)</p>	<p>AF25654 IVECO 1904581</p>  <p>Overall Height: 13.09 (333) Overall OD: 5.87 (149) End 1 ID: 2.82 (72) End 2 ID: 0.34 (9)</p>
<p>AF25625M LETOURNEAU-WESTINGHOUSE 4219820 To be used on models L1400 & L1000</p>  <p>Overall Height: 22.48 (571) Overall OD: 13.83 (351) End 1 ID: 9.48 (241) End 2 ID: 0.90 (23)</p>	<p>AF25635 LEYLAND ACHH325</p>  <p>Overall Height: 14.19 (361) Overall OD: 8.47 (215) End 1 ID: 4.69 (119)</p>	<p>AF25656 INGERSOLL-RAND 32012957</p>  <p>Overall Height: 4.71 (120) Overall OD: 4.35 (110) End 1 ID: 3.00 (76)</p>
<p>AF25626 KASSBOHRER 8319150192</p>  <p>Overall Height: 13.05 (332) End 1 OD: 11.87 (302) End 2 OD: 11.93 (303) End 1 ID: 6.69 (170)</p>	<p>AF25636 AC A1518C Upgrade of AF25757</p>  <p>Height: 2.31 (59) Length: 12.31 (313) Width: 9.75 (248)</p>	<p>AF25657 CATERPILLAR 7T7358</p>  <p>Height: 2.45 (62) Length: 13.00 (330) Width: 12.00 (305)</p>
<p>AF25627 SCANIA 1387548 Primary Air Filter used with AF25468 Primary Air Filter for AF25468 for Komatsu applications</p>  <p>Overall Height: 20.63 (524) Overall OD: 12.21 (310) End 1 ID: 7.07 (180)</p>	<p>AF25638 HINO 178013030A Safety Element used with AF25416</p>  <p>Overall Height: 12.91 (328) End 1 OD: 5.26 (134) End 2 OD: 4.92 (125) End 2 ID: 3.31 (84)</p>	<p>AF25659 CATERPILLAR 8C9657</p>  <p>Height: 2.50 (64) Length: 17.56 (446) Width: 5.98 (152)</p>
<p>AF25628 Replaces NELSON 83626B</p>  <p>Overall Height: 2.39 (61) Overall OD: 4.35 (110) End 1 ID: 3.00 (76)</p>	<p>AF25640 MITSUBISHI ME291563 Safety Element used with AF25365 Sourced from ADR (Indonesia)</p>  <p>Overall Height: 15.75 (400) End 1 OD: 5.26 (133) End 2 OD: 4.92 (125) End 1 ID: 4.36 (111)</p>	<p>AF25660 CATERPILLAR 9X4986</p>  <p>Height: 2.81 (71) Length: 14.86 (377) Width: 4.00 (102)</p>
<p>AF25629 MOTORCRAFT FA1680</p>  <p>Height: 2.30 (58) Length: 13.35 (339) Width: 7.23 (184)</p>	<p>AF25641 ISUZU 8970303250 This product is not available in all regions of the world</p> 	<p>AF25661 CATERPILLAR 9X3352</p>  <p>Height: 2.44 (62) Length: 9.05 (230) Width: 9.05 (230)</p>
<p>AF25630 M.A.N. 81619100011</p>  <p>Height: 1.58 (40) Length: 15.75 (400) Width: 7.09 (180)</p>	<p>AF25647 NELSON 70459C</p>  <p>Overall Height: 11.50 (292) Overall OD: 7.88 (200) End 1 ID: 4.13 (105)</p>	<p>AF25662 CATERPILLAR 9X8216</p>  <p>Height: 2.44 (62) Length: 26.97 (685) Width: 5.98 (152)</p>
<p>AF25631 VOLVO 8149064 Primary Air Filter used with AF26162</p>  <p>Overall Height: 16.30 (414) End 1 OD: 12.66 (322) End 2 OD: 12.01 (305) End 2 ID: 5.91 (150)</p>	<p>AF25648 TOYOTA 177022347071</p>  <p>Overall Height: 10.92 (277) Overall OD: 5.40 (137) End 1 ID: 3.22 (82)</p>	<p>AF25664 CATERPILLAR 1127448</p>  <p>Height: 1.92 (49) Length: 11.28 (287) Width: 8.92 (227)</p>
<p>AF25632 VOLVO 8149961 Primary Air Filter used with AF25317</p>  <p>Overall Height: 16.42 (417) End 1 OD: 13.78 (350) End 2 OD: 13.11 (333) End 2 ID: 7.84 (199)</p>	<p>AF25653 MERCEDES-BENZ 30949604</p>  <p>Overall Height: 13.76 (350) End 1 OD: 13.58 (345) End 2 OD: 10.98 (279) End 2 ID: 4.92 (125)</p>	<p>AF25665 CATERPILLAR 1130305</p>  <p>Height: 2.56 (65) Length: 16.61 (422) Width: 5.51 (140)</p>
<p>AF25633 VOLVO 8149961 Primary Air Filter used with AF25317</p>  <p>Overall Height: 16.42 (417) End 1 OD: 13.78 (350) End 2 OD: 13.11 (333) End 2 ID: 7.84 (199)</p>	<p>AF25655 CATERPILLAR 7T3519</p>  <p>Height: 3.57 (91) Length: 19.69 (500) Width: 3.94 (100)</p>	<p>AF25666 CATERPILLAR 7T3519</p>  <p>Overall Height: 19.00 (483) Overall OD: 9.30 (236) End 1 ID: 5.17 (131)</p>













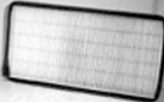









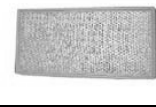

E. PRODUCT GUIDE

<p>AF25668 MOTOR COACH 9G337, BALDWIN PA2839</p>  <p>Overall Height: 15.87 (403) Boot Diameter: 16.85 (428) End 2 OD: 15.09 (383) End 2 ID: 8.26 (210)</p>	<p>AF25682 FORD F7CZ9601A, WIX 46406</p>  <p>Overall Height: 7.90 (201) End 1 OD: 6.87 (174) End 2 OD: 4.64 (118) End 1 ID: 3.15 (80)</p>	<p>AF25690 DONGFENG NISSAN DIESEL 16546DB000 Safety Element used with AF25691 Can not be sold separately. Part of kit AA2954.</p>
<p>AF25670 BOBCAT 6647380</p>  <p>Overall Height: 6.83 (174) Overall OD: 3.66 (93) End 1 ID: 1.71 (44) End 2 ID: 0.34 (9)</p>	<p>AF25683 FORD F67Z9601AA, MOTORCRAFT FA1641, FORD F67X9601AA, CHAMP AF1641</p>  <p>Overall Height: 5.91 (150) End 1 OD: 6.96 (177) End 2 OD: 5.30 (135) End 1 ID: 3.15 (80)</p>	<p>AF25691 DONGFENG NISSAN DIESEL 16546DB000 Primary Air Filter used with AF25690</p> <p>AF25693 NELSON 870710N, NELSON 870710A</p>  <p>Overall Height: 22.30 (566) End 1 OD: 10.41 (264) End 2 OD: 7.79 (198) End 1 ID: 5.80 (147) End 2 ID: 3.14 (80)</p>
<p>AF25672 NELSON 87295A, CATERPILLAR 7X6041 Height includes 43 mm pull tab</p>  <p>Height: 2.44 (62) Length: 12.24 (311) Width: 9.49 (241)</p>	<p>AF25684 FORD F77X9601AA, FORD F77Z9601AA, MOTORCRAFT FA1658, CHAMP AF1658</p>  <p>Height: 2.26 (57) Length: 8.75 (222) Width: 7.52 (191)</p>	<p>AF25694 INTERNATIONAL TRUCKS 3507421C1</p>  <p>Overall Height: 23.50 (597) End 1 OD: 9.65 (245) End 2 OD: 9.25 (235) End 2 ID: 5.13 (130)</p>
<p>AF25674 CASE K945043 Primary Air Filter used with AF25686</p>  <p>Overall Height: 10.75 (273) Overall OD: 6.08 (155) End 1 ID: 3.78 (96) End 2 ID: 0.69 (18)</p>	<p>AF25685 DONALDSON P922118 Navistar 9800 Series</p>  <p>Overall Height: 26.36 (670) End 1 OD: 11.06 (281) End 2 OD: 7.52 (191) End 1 ID: 6.87 (175)</p>	<p>AF25695 MERCEDES-BENZ 8301118</p>  <p>Height: 1.50 (38) Length: 14.96 (380) Width: 5.32 (135)</p>
<p>AF25675 DONALDSON P776490, CATERPILLAR 7R2258</p>  <p>Height: 17.17 (436) Length: 6.00 (152) Width: 2.20 (56)</p>	<p>AF25686 MC CORMICK K952344 Safety Element used with AF25674</p>  <p>Overall Height: 9.57 (243) Overall OD: 3.71 (94) End 1 ID: 2.56 (65) End 2 ID: 0.42 (11)</p>	<p>AF25696 RENAULT V.I. 7701044595</p>  <p>Height: 1.69 (43) Length: 12.40 (315) Width: 10.32 (262)</p>
<p>AF25676 JOHN DEERE AM108185, NELSON 70751A Safety Element used with AF25580KM</p>  <p>Overall Height: 7.00 (178) Flange Diameter: 4.50 (114) End 2 OD: 2.30 (58) End 1 ID: 2.07 (53) End 2 ID: 0.66 (17)</p>	<p>AF25687 MACK 57MD46M</p>  <p>Overall Height: 25.50 (648) Overall OD: 9.40 (239) End 1 ID: 5.90 (150) End 2 ID: 5.90 (150)</p>	<p>AF25697 ELIXAIRE 2244665000, FREIGHTLINER 2244665000</p>  <p>Height: 10.60 (269) Length: 10.60 (269) Width: 0.75 (19)</p>
<p>AF25677 CATERPILLAR 3E0410, NELSON 87495A</p>  <p>Height: 1.25 (32) Length: 9.00 (229) Width: 7.00 (178)</p>	<p>AF25688 CUMMINS 3351735</p>  <p>Overall Height: 16.38 (416) End 1 OD: 15.11 (384) End 2 OD: 11.10 (282) End 2 ID: 6.64 (169)</p>	<p>AF25700 CASE 294292A1, IHC 294292A1 Primary Air Filter used with AF25701</p>  <p>Overall Height: 11.66 (296) End 1 OD: 13.35 (339) End 2 OD: 13.33 (339) End 2 ID: 8.21 (208)</p>
<p>AF25678 JOHN DEERE AH92463, NELSON 83754A</p>  <p>Height: 1.19 (30) Length: 16.50 (419) Width: 5.00 (127)</p>	<p>AF25689K CASE D56453</p>  <p>Overall Height: 15.44 (392) Fin Diameter: 7.81 (198) End 2 OD: 6.09 (155) End 1 ID: 3.47 (88) End 2 ID: 0.69 (17)</p>	<p>AF25701 CASE 294293A1 Safety Element used with AF25700</p>  <p>Overall Height: 10.72 (272) End 1 OD: 8.11 (206) End 2 OD: 7.69 (195) End 1 ID: 5.94 (151)</p>
<p>AF25680 CATERPILLAR 2G1946, BALDWIN PA3482</p>  <p>Height: 0.81 (21) Length: 13.25 (337) Width: 11.94 (303)</p>		













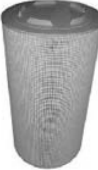













E. PRODUCT GUIDE

<p>AF25702 KUBOTA 6C04094250 Safety Element used with AF25703K</p>  <p>Overall Height: 6.22 (158) End 1 OD: 2.17 (55) End 2 OD: 2.01 (51) End 1 ID: 1.58 (40) End 2 ID: 0.67 (17)</p>	<p>AF25709 FORD 6610580</p>  <p>Height: 2.28 (58) Length: 12.44 (316) Width: 5.91 (150)</p>	<p>AF25724 KHD(KLOCKNER-HUMBOLDT-DEUTZ) 1180872 Safety Element used with AF25723</p>  <p>Overall Height: 15.04 (382) End 1 OD: 4.21 (107) End 2 OD: 4.11 (105) End 1 ID: 3.70 (94)</p>
<p>AF25703K KUBOTA 6C04094240 Primary Air Filter used with AF25702</p>  <p>Overall Height: 7.28 (185) Fin Diameter: 4.25 (108) End 2 OD: 3.29 (84) End 1 ID: 2.13 (54) End 2 ID: 0.67 (17)</p>	<p>AF25710 CASE 367349A1 Primary Air Filter used with AF25711</p>  <p>Overall Height: 13.90 (353) Overall OD: 12.09 (307) End 1 ID: 8.21 (208)</p>	<p>AF25725 ATLAS COPCO 2914930000 Primary Air Filter used with AF25726</p>  <p>Overall Height: 9.96 (253) End 1 OD: 4.54 (115) End 2 OD: 4.49 (114) End 2 ID: 2.52 (64)</p>
<p>AF25704 DAF 1385791</p>  <p>Overall Height: 17.09 (434) Overall OD: 9.61 (244) End 1 ID: 4.92 (125)</p>	<p>AF25711 CASE 367350A1 Safety Element used with AF25710</p>  <p>Overall Height: 12.96 (329) End 1 OD: 8.11 (206) End 2 OD: 7.69 (195) End 1 ID: 5.94 (151)</p>	<p>AF25726 KHD(KLOCKNER-HUMBOLDT-DEUTZ) 1180868 Safety Element used with AF25725</p>  <p>Overall Height: 9.25 (235) End 1 OD: 2.24 (57) End 2 OD: 2.15 (55) End 1 ID: 1.73 (44)</p>
<p>AF25705 KOBELCO LQ11PU0001S002 Primary Air Filter used with AF25706</p>  <p>Overall Height: 14.75 (375) Overall OD: 9.18 (233) End 1 ID: 5.88 (149)</p>	<p>AF25713 CATERPILLAR 6C9226, TEREX 15270794</p>  <p>Height: 1.00 (25) Length: 11.81 (300) Width: 9.84 (250)</p>	<p>AF25727 KHD(KLOCKNER-HUMBOLDT-DEUTZ) 1319142 Primary Air Filter used with AF25728</p>  <p>Overall Height: 12.60 (320) End 1 OD: 4.92 (125) End 2 OD: 4.89 (124) End 2 ID: 2.91 (74)</p>
<p>AF25706 KOBELCO LQ11PU0001S001 Safety Element used with AF25705</p>  <p>Overall Height: 12.88 (327) Overall OD: 5.56 (141) End 1 ID: 4.40 (112)</p>	<p>AF25719 MERCEDES-BENZ 6380900151</p>  <p>Height: 2.70 (69) Length: 13.07 (332) Width: 10.32 (262)</p>	<p>AF25728 DEUTZ AG 1180869 Safety Element used with AF25727</p>  <p>Overall Height: 11.89 (302) End 1 OD: 2.64 (67) End 2 OD: 2.54 (65) End 1 ID: 2.13 (54)</p>
<p>AF25707 INTERNATIONAL TRUCKS 3532799C1 Primary Air Filter used with AF25732</p>  <p>Overall Height: 16.00 (406) End 1 OD: 10.22 (260) End 2 OD: 10.19 (259) End 1 ID: 7.97 (202)</p>	<p>AF25720K TOYOTA 17803F980171 Primary Air Filter used with AF25741</p>  <p>Overall Height: 11.52 (293) Fin Diameter: 6.34 (161) End 2 OD: 5.24 (133) End 1 ID: 3.35 (85) End 2 ID: 0.67 (17)</p>	<p>AF25729 BOMAG 5821149 Primary Air Filter used with AF25730</p>  <p>Overall Height: 16.08 (409) End 1 OD: 8.59 (218) End 2 OD: 8.54 (217) End 2 ID: 4.88 (124)</p>
<p>AF25708 NELSON 871148A</p>  <p>Overall Height: 20.54 (522) Overall OD: 11.02 (280) End 2 ID: 7.93 (201)</p>	<p>AF25721 KHD(KLOCKNER-HUMBOLDT-DEUTZ) 4415905 Primary Air Filter used with AF25722</p>  <p>Overall Height: 14.80 (376) End 1 OD: 6.27 (159) End 2 OD: 6.22 (158) End 2 ID: 3.70 (94)</p>	<p>AF25730 BOMAG 5821150 Safety Element used with AF25729</p>  <p>Overall Height: 15.12 (384) End 1 OD: 4.61 (117) End 2 OD: 4.51 (115) End 1 ID: 4.09 (104)</p>
<p>AF25708M NELSON 870904A Filter used with AH19257, AH19266, AH19273, AH19274</p>  <p>Overall Height: 20.50 (521) Overall OD: 11.00 (279) End 2 ID: 8.10 (206)</p>	<p>AF25722 ATLAS COPCO 1615892700 Safety Element used with AF25721</p>  <p>Overall Height: 14.06 (357) End 1 OD: 3.43 (87) End 2 OD: 3.31 (84) End 1 ID: 2.91 (74)</p>	<p>AF25731 MERCEDES-BENZ A0040941104</p>  <p>Height: 3.11 (79) Length: 24.80 (630) Width: 22.44 (570)</p>
<p>AF25708M (continued)</p>  <p>Overall Height: 20.50 (521) Overall OD: 11.00 (279) End 2 ID: 8.10 (206)</p>	<p>AF25723 KHD(KLOCKNER-HUMBOLDT-DEUTZ) 1180867 Primary Air Filter used with AF25724 Radial Seal</p>  <p>Overall Height: 15.79 (401) End 1 OD: 7.69 (195) End 2 OD: 7.64 (194) End 2 ID: 4.49 (114)</p>	







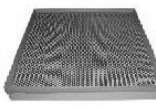

















E. PRODUCT GUIDE

AF25732  INTERNATIONAL TRUCKS 3532800C1 Safety Element used with AF25707 Overall Height: 15.39 (391) Overall OD: 8.09 (205) End 1 ID: 5.28 (134)	AF25747  Safety Element used with AF25746 Overall Height: 16.02 (407) End 1 OD: 5.30 (135) End 2 OD: 5.17 (131) End 1 ID: 3.26 (83)	AF25756  VOLVO CONSTRUCTION EQUIPMENT 11110022 Primary Air Filter used with AF25523 Overall Height: 20.65 (525) Overall OD: 11.06 (281) End 1 ID: 5.91 (150)
AF25733  MERCEDES-BENZ 8356947 Height: 1.12 (29) Length: 13.47 (342) Width: 7.15 (182)	AF25748  RENAULT AGRICULTURE 7700050840 Primary Air Filter used with AF25749 Overall Height: 18.66 (474) Overall OD: 9.29 (236) End 1 ID: 5.20 (132)	AF25757  AC A1519C, GMC 25313348 For Upgrade, use AF25636 Light Duty Height: 9.75 (248) Length: 12.31 (313) Width: 2.31 (59)
AF25734  CATERPILLAR 4P0710 Overall Height: 14.38 (365) Overall OD: 19.35 (492) End 1 ID: 12.93 (329)	AF25749  RENAULT AGRICULTURE 7700050841 Safety Element used with AF25748 Overall Height: 17.72 (450) End 1 OD: 5.20 (132) End 2 OD: 4.96 (126) End 1 ID: 3.70 (94)	AF25758M  GMC 2062062 Overall Height: 8.05 (204) Overall OD: 12.08 (307) End 1 ID: 6.69 (170)
AF25735  FIAT HITACHI 1930601 Safety Element used with AF25740K Overall Height: 11.95 (304) End 1 OD: 5.97 (152) End 2 OD: 5.96 (151) End 1 ID: 0.67 (17) End 2 ID: 4.85 (123)	AF25750  NELSON 871064N Overall Height: 23.58 (599) End 1 OD: 16.25 (413) End 2 OD: 13.81 (351) End 1 ID: 9.50 (241)	AF25761  AIR REFINER ARM1510 Is a shorter version of AF953K without the fin Overall Height: 9.68 (246) Overall OD: 6.08 (154) End 1 ID: 3.48 (88) End 2 ID: 0.67 (17)
AF25740K  FIAT HITACHI 1930600 Primary Air Filter used with AF25735 Overall Height: 13.47 (342) Fin Diameter: 11.73 (298) End 2 OD: 9.67 (246) End 1 ID: 6.06 (154) End 2 ID: 0.63 (16)	AF25751  NELSON 870178N Overall Height: 19.30 (490) Overall OD: 15.12 (384) End 1 ID: 10.00 (254)	AF25762  JOHN DEERE AT69308 Is a short version of AF1828 Overall Height: 16.59 (421) End 1 OD: 12.80 (325) End 2 OD: 12.08 (307) End 1 ID: 0.90 (23) End 2 ID: 7.73 (196)
AF25741  TOYOTA 178042300071 Safety Element used with AF25720K Overall Height: 10.37 (264) Overall OD: 3.23 (82) End 1 ID: 2.54 (65) End 2 ID: 0.48 (12)	AF25752  NELSON 870179N Overall Height: 18.30 (465) End 1 OD: 9.89 (251) End 2 OD: 9.88 (251) End 1 ID: 8.05 (204)	AF25763M  AIR REFINER ARM529241 Primary Air Filter used with AF25764 Is a short version of AF975M Overall Height: 18.55 (471) Overall OD: 10.86 (276) End 1 ID: 6.50 (165) End 2 ID: 0.92 (23)
AF25742  GMC 25099849 Engine Application Height: 2.08 (53) Length: 15.93 (405) Width: 7.90 (201)	AF25753  MANITOU 177178 Safety Element used with AF25006K Overall Height: 10.12 (257) End 1 OD: 3.07 (78) End 2 OD: 2.62 (67) End 1 ID: 2.21 (56) End 2 ID: 0.34 (9)	AF25764  FRAM CA7106SY Safety Element used with AF25763M Is a short version of AF976 Overall Height: 17.43 (443) End 1 OD: 6.41 (163) End 2 OD: 6.39 (162) End 1 ID: .67 (17) End 2 ID: 5.27 (134)
AF25745  KUBOTA 6A10082632 Overall Height: 6.99 (178) Overall OD: 3.66 (93) End 1 ID: 1.71 (44)	AF25754  GMC 25099149 Height: 7.16 (182) Length: 9.41 (239) Width: 1.59 (40)	AF25767  MASSEY-FERGUSON 3902806M1 Primary Air Filter used with AF25768 Overall Height: 21.36 (543) Overall OD: 9.51 (242) End 2 ID: 5.57 (142)
AF25746  Primary Air Filter used with AF25747 Overall Height: 16.92 (430) Overall OD: 8.82 (224) End 1 ID: 5.12 (130)	AF25755  RENAULT AGRICULTURE 7700039510 Safety Element used with AF25504 Overall Height: 14.35 (365) End 1 OD: 4.29 (109) End 2 OD: 4.06 (103) End 1 ID: 3.47 (88)	

E. PRODUCT GUIDE

AF25768  MASSEY-FERGUSON 3902812M1 Safety Element used with AF25767 Overall Height: 20.43 (519) End 1 OD: 5.41 (138) End 2 OD: 5.32 (135) End 1 ID: 4.92 (125)	AF25777 CASE 1970006C2  Height: 2.19 (56) Length: 20.00 (508) Width: 9.00 (229)	AF25791 NEW HOLLAND 9672473, NEW HOLLAND 107219  Height: 2.19 (56) Length: 28.00 (711) Width: 6.00 (152)
AF25769  ATLAS COPCO 2914501700 Primary Air Filter used with AF25770 Overall Height: 23.39 (594) Overall OD: 11.73 (298) End 2 ID: 8.07 (205)	AF25778 CRENLO 120621  Height: 2.69 (68) Length: 26.97 (685) Width: 6.25 (159)	AF25792 RED DOT 585820  Height: 1.25 (32) Length: 15.00 (381) Width: 8.00 (203)
AF25770  ATLAS COPCO 2914501800 Safety Element used with AF25769 Overall Height: 22.44 (570) End 1 OD: 7.72 (196) End 2 OD: 7.60 (193) End 1 ID: 7.21 (183)	AF25779  AGCO 559300, EXCEL 37077, MELROE 6620654 Height: 2.19 (56) Length: 28.00 (711) Width: 7.50 (191)	AF25794  MANITOU 563415 Safety Element used with AF25795 Overall Height: 13.01 (331) End 1 OD: 3.66 (93) End 2 OD: 3.43 (87) End 1 ID: 2.84 (72)
AF25771  Replaces NELSON 70855N Overall Height: 19.38 (492) End 1 OD: 13.72 (348) End 2 OD: 12.09 (307) End 1 ID: 9.25 (235)	AF25780  CATERPILLAR 1807487 Height: 2.56 (65) Length: 16.85 (428) Width: 11.73 (298)	AF25795  MANITOU 563416 Primary Air Filter used with AF25794 Overall Height: 13.60 (346) Overall OD: 6.38 (162) End 1 ID: 3.62 (92)
AF25772  TAMROCK 88021199 Overall Height: 24.21 (615) Overall OD: 4.53 (115) Thread Size: M62X4	AF25781  CATERPILLAR 1193355 Height: 2.56 (65) Length: 15.94 (405) Width: 7.87 (200)	AF25797  RENAULT V.I. 5001847123 Height: 2.22 (57) Length: 12.40 (315) Width: 10.32 (262)
AF25773  CUMMINS 3430460 Height: 6.26 (159) Length: 17.72 (450) Width: 18.70 (475)	AF25782  NELSON 870404G Height: 2.44 (62) Length: 32.76 (832) Width: 3.87 (98)	AF25799  CUMMINS 3429703 Height: 6.26 (159) Length: 13.78 (350) Width: 17.72 (450)
AF25774  CASE 139768A1 Height: 2.44 (62) Length: 12.18 (309) Width: 4.00 (102)	AF25783  AGCO 71362389 Height: 2.19 (56) Length: 24.00 (610) Width: 9.00 (229)	AF25801  NISSAN 1654621566 Primary Air Filter used with AF4658 Overall Height: 15.34 (390) End 1 OD: 12.08 (307) End 2 OD: 12.02 (305) End 1 ID: 7.73 (196) End 2 ID: 0.67 (17)
AF25775  JOHN DEERE AT141209 Height: 2.44 (62) Length: 14.75 (375) Width: 4.88 (124)	AF25784  NEW HOLLAND 627749 Height: 2.19 (56) Length: 30.00 (762) Width: 9.50 (241)	AF25810  DONGFENG HONDA AUTO. CO.,LTD 1109R65020 Primary Air Filter used with AF25811
AF25776  CATERPILLAR 7T8945, CATERPILLAR 7X6012 Height: 2.50 (64) Length: 9.05 (230) Width: 9.05 (230)	AF25785  JOHN DEERE AT170037 Height: 2.31 (59) Length: 14.76 (375) Width: 6.89 (175)	AF25811  DONGFENG HONDA AUTO. CO.,LTD 1109R65030 Safety Element used with AF25810
	AF25786  CRENLO 128151 Height: 2.69 (68) Length: 26.97 (685) Width: 6.25 (159)	AF25825  KHD(KLOCKNER- HUMBOLDT-DEUTZ) 12134578 Height: 2.87 (73) Length: 19.57 (497) Width: 19.57 (497)

E. PRODUCT GUIDE

AF25827  CUMMINS 4013821 Applied on Cummins PowerGen Units/Landfill Equipment with QSV81/91 Liter Natural Gas	AF25856  NELSON 70988F Primary Air Filter used with AF25857 Used in Reytor housing RT1216M Overall Height: 16.75 (425) Overall OD: 9.30 (236) End 1 ID: 4.90 (124)	AF25878  ONAN 1402638 Safety Element used with AF25877 Filter used with AH19323 Overall Height: 19.11 (486) Overall OD: 6.85 (174) End 1 ID: 5.41 (138) End 2 ID: 0.62 (16)
AF25829  SCANIA 1420197 Height: 2.70 (69) Length: 9.17 (233) Width: 6.85 (174)	AF25857  NELSON 70989F Safety Element used with AF25856 Used in Reytor housing RT1216M Overall Height: 15.50 (394) End 1 OD: 5.10 (130) End 2 OD: 4.90 (124) End 1 ID: 4.10 (104)	AF25886  CATERPILLAR 1080671 Primary Air Filter used with AF25887 Overall Height: 11.59 (295) Overall OD: 8.19 (208) End 1 ID: 4.17 (106)
AF25830  VOLVO CONSTRUCTION EQUIPMENT 11110217 Primary Air Filter used with AF25897 Overall Height: 19.33 (491) Overall OD: 14.15 (360) End 1 ID: 8.92 (227)	AF25858  Is a short version of AF25247 Overall Height: 21.57 (548) End 1 OD: 11.22 (285) End 2 OD: 11.15 (283) End 1 ID: 6.82 (173)	AF25887  CATERPILLAR 1080672 Safety Element used with AF25886 Overall Height: 10.83 (275) End 1 OD: 4.25 (108) End 2 OD: 4.02 (102) End 1 ID: 2.60 (66)
AF25840  DAF 1322255 Height: 1.02 (26) Length: 12.60 (320) Width: 9.27 (236)	AF25872  DAF 1433690 Overall Height: 13.23 (336) Overall OD: 8.47 (215) End 1 ID: 4.69 (119)	AF25888  CARRIER 300043022 Overall Height: 9.90 (252) End 1 OD: 4.41 (112) End 2 OD: 3.92 (100) End 1 ID: 2.34 (60)
AF25841  FORD 4041615 Height: 2.26 (58) Length: 10.95 (278) Width: 7.07 (180)	AF25873  DAF 1433697 Overall Height: 16.38 (416) Overall OD: 8.47 (215) End 1 ID: 4.69 (119)	AF25889  DYNAPAC 380294 Safety Element used with AF25890 Overall Height: 9.11 (232) End 1 OD: 3.31 (84) End 2 OD: 3.07 (78) End 1 ID: 2.48 (63)
AF25848  Duramax Diesel Height: 2.31 (59) Length: 12.31 (313) Width: 9.75 (248)	AF25875  IVECO 42471161 Flame Retardant Media Overall Height: 13.15 (334) Overall OD: 9.72 (247) End 2 ID: 5.47 (139)	AF25890  DYNAPAC 380295 Primary Air Filter used with AF25889 Overall Height: 9.69 (246) Overall OD: 4.96 (126) End 1 ID: 3.21 (82)
AF25849  MASSEY-FERGUSON 3388840M2 Height: 2.40 (61) Length: 34.65 (880) Width: 5.32 (135)	AF25876  IVECO 42471166 Flame Retardant Media Overall Height: 15.43 (392) Overall OD: 9.72 (247) End 2 ID: 5.47 (139)	AF25893  KALMAR 9238720542 Overall Height: 18.39 (467) Overall OD: 13.83 (351) End 1 ID: 9.48 (241) End 2 ID: 0.54 (14)
AF25852  INGERSOLL-RAND 39708466 Overall Height: 12.87 (327) Overall OD: 5.44 (138) End 1 ID: 3.20 (81)	AF25877  ONAN 1402636 Primary Air Filter used with AF25878 Filter used with AH19323 Overall Height: 20.65 (525) Overall OD: 11.54 (293) End 1 ID: 7.01 (178) End 2 ID: 0.39 (10)	AF25894  M.A.N. 81084050016 Primary Air Filter used with AF25896 Flame Retardant Media Overall Height: 20.08 (510) Overall OD: 10.51 (267) End 2 ID: 6.26 (159)

E. PRODUCT GUIDE

AF25895 IVECO 500339085



Overall Height: 2.42 (62)
Largest OD: 3.17 (81)
Thread Size: M16X1.5

AF25896 M.A.N. 81084050017 Safety Element used with AF25894, AF26353



Overall Height: 17.97 (457)
End 1 OD: 6.14 (156)
End 2 OD: 6.12 (156)
Thread Size: 143 X 6 (DIN 6063)

AF25897 VOLVO 11110218, VOLVO CONSTRUCTION EQUIPMENT 11110218 Safety Element used with AF25830



Overall Height: 19.04 (484)
End 1 OD: 9.06 (230)
End 2 OD: 8.66 (220)
End 1 ID: 7.01 (178)

AF25898 RENAULT V.I. 5010315990



Overall Height: 14.59 (371)
End 1 OD: 9.65 (245)
End 2 OD: 9.61 (244)
End 1 ID: 4.98 (127)

AF25899 M.A.N. 81083040093



Overall Height: 19.61 (498)
Overall OD: 9.76 (248)
End 1 ID: 4.72 (120)

AF25904 CUMMINS 4071693



Overall Height: 9.71 (247)
Overall OD: 5.12 (130)
End 1 ID: 2.76 (70)
End 2 ID: 0.43 (11)

AF25906 CUMMINS 4055592



Overall Height: 24.49 (622)
Overall OD: 14.25 (362)
End 1 ID: 9.88 (251)
End 2 ID: 0.93 (24)

AF25907 CUMMINS 4055591



Overall Height: 22.26 (566)
Overall OD: 9.80 (249)
End 1 ID: 8.68 (221)
End 2 ID: 0.90 (23)

AF25910 CUMMINS 3814695



Overall Height: 12.03 (306)
Overall OD: 7.78 (198)
End 1 ID: 4.33 (110)
End 2 ID: 0.34 (9)

AF25911 CUMMINS 3814696



Overall Height: 10.87 (276)
Overall OD: 4.09 (104)
End 1 ID: 3.58 (91)
End 2 ID: 0.66 (17)

AF25913 CUMMINS 3815068



Overall Height: 12.34 (314)
Overall OD: 9.09 (231)
End 1 ID: 4.78 (122)
End 2 ID: 0.39 (10)

AF25914 CUMMINS 3815069



Overall Height: 9.31 (237)
Overall OD: 4.72 (120)
End 1 ID: 3.98 (101)
End 2 ID: 0.64 (16)

AF25919 Primary Air Filter used with AF25928



AF25921 Primary Air Filter used with AF25930



AF25928 Safety Element used with AF25919



AF25930 Safety Element used with AF25921



AF25937 Primary Air Filter used with AF25946



AF25939 Primary Air Filter used with AF25948



AF25946 Safety Element used with AF25937



AF25948 Safety Element used with AF25939



AF25952M Is a longer version of AF25525



Overall Height: 25.45 (646)
End 1 OD: 9.32 (237)
End 2 OD: 9.23 (234)
End 1 ID: 5.78 (147)

AF25953 VOLVO-BM 11007848



Height: 2.76 (70)
Length: 15.55 (395)
Width: 12.99 (330)

AF25954 VOLVO-BM 11007847



Height: 0.59 (15)
Length: 18.11 (460)
Width: 15.67 (398)

AF25955 BALDWIN RS4572 Has the same design features as the AF25248 except it is 4 inches shorter.



Overall Height: 22.14 (562)
End 1 OD: 12.92 (328)
End 2 OD: 12.80 (325)
End 1 ID: 7.46 (189)

AF25956 MERCEDES-BENZ 8303318



Height: 1.06 (27)
Length: 14.80 (376)
Width: 6.77 (172)

AF25957 FENDT H411201090100 Primary Air Filter used with AF25618



Overall Height: 15.53 (395)
Overall OD: 7.24 (184)
End 1 ID: 4.13 (105)

AF25958K J.C.B. 32913601 Primary Air Filter used with AF4654



Overall Height: 12.05 (306)
Cover Diameter: 7.13 (181)
Fin Diameter: 6.34 (161)
End 2 ID: 2.82 (72)
Thread Size: M10 X 1.5-6H INT

AF25959 Filter used with AH19330



Overall Height: 10.80 (274)
End 1 OD: 4.13 (105)
End 1 ID: 3.00 (76)

AF25960 Primary Air Filter used with AF25961 Filter used with AH19260, AH19261, AH19331, AH19332, AH19490, AH19491 8" OptiAir 800 Series

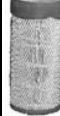

Overall Height: 14.08 (358)
End 1 OD: 6.42 (163)
End 2 OD: 6.41 (163)
End 1 ID: 4.90 (124)

AF25961 Safety Element used with AF25960 Filter used with AH19260, AH19331, AH19490 OptiAir 800 Series Safety Element



Overall Height: 13.16 (334)
End 1 OD: 5.02 (128)
End 2 OD: 3.39 (86)

AF25962 Primary Air Filter used with AF25963 Filter used with AH19333, AH19334 11" OptiAir 1100 Series



Overall Height: 16.80 (427)
End 1 OD: 8.80 (224)
End 1 ID: 7.14 (181)

AF25963 Safety Element used with AF25962 Filter used with AH19334 11" OptiAir 1100 Series



Overall Height: 15.96 (405)
End 1 OD: 7.25 (184)
End 2 OD: 4.77 (121)

AF25964 TIMBERJACK F434072 Primary Air Filter used with AF25491





























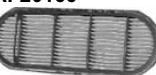

Overall Height: 16.58 (421)
Overall OD: 8.19 (208)
End 1 ID: 4.17 (106)

E. PRODUCT GUIDE

AF25966M TOWMOTOR 690826 Flame Retardant Media Overall Height: 9.02 (229) End 1 OD: 6.85 (174) End 2 OD: 6.83 (174) End 2 ID: 4.23 (107)	AF25997 VOLKSWAGEN 2S0129620 Primary Air Filter used with AF26211 Overall Height: 16.09 (409) End 1 OD: 10.35 (263) End 2 OD: 10.24 (260) End 1 ID: 5.87 (149)	AF26112M FORD F6HZ9601BA Overall Height: 17.22 (437) End 1 OD: 13.05 (331) End 2 OD: 12.90 (328) End 1 ID: 6.78 (172)
AF25967 BOBCAT 6673753 Safety Element used with AF25538 Overall Height: 6.06 (154) End 1 OD: 1.79 (46) End 2 OD: 1.52 (39) End 1 ID: 1.12 (29)	AF26044 CUMMINS POWER GENERATION LTD 1404157	AF26113 CUMMINS 3683458 Filter used with 3941157 Cummins ISX and ISM Applications Overall Height: 2.56 (65) Thread Size: M16 X 1.5-6H INT
AF25968 MC CORMICK 334755A2 Height: 1.02 (26) Length: 19.02 (483) Width: 6.10 (155)	AF26046M TATA 253409130241	AF26114 CASE 249988A1 Safety Element used with AF25667 Freightliner Truck Class 7 Model FL70 & FL80 Class Overall Height: 18.43 (468) End 1 OD: 5.20 (132) End 2 OD: 4.96 (126) End 1 ID: 3.70 (94)
AF25969 SCANIA 1335680 Safety Element used with AF25313 Overall Height: 19.82 (504) End 1 OD: 6.68 (170) End 2 OD: 6.44 (164) End 1 ID: 5.22 (133)	AF26103 IHC 3551814C1 Overall Height: 16.10 (409) End 1 OD: 11.98 (304) End 1 ID: 9.93 (252)	AF26116 Primary Air Filter used with AF26167 Filter used with AH19474, AH19484, AH19485, AH19496 4" OptiAir 400 Series. Overall Height: 7.08 (180) End 1 OD: 3.55 (90) End 2 OD: 3.50 (89) End 1 ID: 2.38 (61)
AF25972 IVECO 500387947 Height: 1.38 (35) Length: 17.21 (437) Width: 3.92 (100)	AF26105 REYTOR IT2015S Overall Height: 16.19 (411) End 1 OD: 6.07 (154) End 2 OD: 5.60 (142)	AF26117 Primary Air Filter used with AF26118 Filter used with AH19476, AH19477, AH19488, AH19489 6" OptiAir 600 Series. Overall Height: 313.0 (7950) End 1 OD: 131.2 (3332) End 2 OD: 130.0 (3302) End 2 ID: 94.5 (2400)
AF25975 DAF 1657523 Flame Retardant Media Overall Height: 19.09 (485) End 1 OD: 10.59 (269) End 2 OD: 10.43 (265) End 1 ID: 6.38 (162)	AF26106 CHRYSLER 53032700AB Inside/out flow Height: 2.78 (71) Length: 10.91 (277) Width: 9.92 (252)	AF26118 Safety Element used with AF26117 Filter used with AH19477, AH19488 OptiAir 600 Series Safety Element Overall Height: 297.0 (7541) End 1 OD: 158.4 (4023) End 2 OD: 87.6 (2225) End 1 ID: 44.1 (1120)
AF25976 DAF 1657522 Flame Retardant Media Overall Height: 16.73 (425) End 1 OD: 10.59 (269) End 2 OD: 10.43 (265) End 1 ID: 6.38 (162)	AF26107 INTERNATIONAL TRUCKS 3532799C1 OptiAir replacement with flame retardant media Overall Height: 16.00 (406) End 1 OD: 10.22 (260) End 2 OD: 10.19 (259) End 1 ID: 7.97 (202)	AF26119 MC CORMICK 248124A1 Height: 2.24 (57) Length: 18.47 (469) Width: 4.59 (117)
AF25977 WAUKESHA 169180A, WAUKESHA 169180C Height: 5.25 (133) Length: 25.50 (648) Width: 19.50 (495)	AF26108 KHD(KLOCKNER-HUMBOLDT-DEUTZ) 4411228 Height: 2.76 (70) Length: 21.97 (558) Width: 2.95 (75)	AF26120 Primary Air Filter used with AF26121 Filter used with AH19478, AH19479 10" OptiAir 1000 Series Overall Height: 14.86 (377) End 1 OD: 7.59 (193) End 2 OD: 7.55 (192) End 1 ID: 5.77 (147)
AF25978 NEW HOLLAND 1930825 Safety Element used with AF25342, AF25348K Overall Height: 12.05 (306) End 1 OD: 4.13 (105) End 2 OD: 3.35 (85) End 1 ID: 2.95 (75) End 2 ID: 0.67 (17)	AF26109 Quincy Air Compressor Model 120382 Overall Height: 19.50 (495) End 1 OD: 6.22 (158) End 2 OD: 7.36 (187) End 1 ID: 6.22 (158) End 2 ID: 7.36 (187)	AF26111M REYTOR IT2015 Overall Height: 17.67 (449) End 1 OD: 11.11 (282) End 2 OD: 10.96 (278) End 1 ID: 5.87 (149)

E. PRODUCT GUIDE

<p>AF26121 Safety Element used with AF26120 Filter used with AH19479 10" OptiAir 1000 Series</p>  <p>Overall Height: 14.15 (360) End 1 OD: 5.89 (150) End 2 OD: 4.13 (105) End 1 ID: 2.98 (76)</p>	<p>AF26147 ATLAS COPCO 3214623900</p>  <p>Overall Height: 23.62 (600) Overall OD: 4.72 (120) Thread Size: M76X4</p>	<p>AF26159 HUMMER 88944151</p> 
<p>AF26124 Primary Air Filter used with AF26125 Filter used with AH19480, AH19481 OptiAir 1300 Series Primary Element</p>  <p>Overall Height: 20.46 (520) End 1 OD: 10.33 (262) End 2 OD: 10.31 (262) End 1 ID: 8.04 (204)</p>	<p>AF26149K CASE 87300211, NEW HOLLAND 87300210 CNH Class 4 Compact Tractors with ISM (Shibaura) engines. New Holland and Boomer Utility Tractors (48 and 55 Gross hp)</p>  <p>Overall Height: 11.50 (292) Fin Diameter: 6.41 (163) End 2 OD: 5.25 (133) End 1 ID: 3.25 (83) End 2 ID: 0.66 (17)</p>	<p>AF26161 CASE 87300190, NEW HOLLAND 87300189 CNH Class 1 Compact Tractors with ISM (Shibaura) Engine</p> 
<p>AF26125 Safety Element used with AF26124 Filter used with AH19481 OptiAir 1300 Series Safety Element</p>  <p>Overall Height: 19.52 (496) End 1 OD: 8.05 (204) End 2 OD: 4.13 (105) End 1 ID: 5.24 (133)</p>	<p>AF26150 CASE 87300209, NEW HOLLAND 87300208 CNH Class 4 Compact Tractors with ISM (Shibaura) Engines</p>  <p>Overall Height: 9.98 (253) End 1 OD: 2.92 (74) End 1 ID: 2.38 (60) End 2 ID: .44 (11)</p>	<p>AF26162 VOLVO 3979928 Safety Element used with AF25631</p>  <p>Overall Height: 17.36 (441) End 1 OD: 6.63 (169) End 2 OD: 5.63 (143) End 1 ID: 5.37 (137)</p>
<p>AF26131 FORD 4L3Z9601BA</p>  <p>Height: 1.41 (36) Length: 11.30 (287) Width: 8.50 (216)</p>	<p>AF26152 FORD 3C3Z9601BA</p> 	<p>AF26163M VOLVO 20411815 Primary Air Filter used with AF26212 Applied on Volvo Trucks with Cummins ISX engine.</p>  <p>Overall Height: 19.52 (496) End 1 OD: 13.05 (331) End 2 OD: 12.90 (328) End 1 ID: 9.21 (234)</p>
<p>AF26139 FODEN 1322259</p>  <p>Height: 1.02 (26) Length: 16.93 (430) Width: 6.54 (166)</p>	<p>AF26153 Freightliner M2 Truck Applications</p> 	<p>AF26165 MERCEDES-BENZ 40942404</p>  <p>Overall Height: 13.56 (345) Cover Diameter: 20.47 (520) End 2 OD: 16.02 (407) End 1 ID: 8.73 (222)</p>
<p>AF26140 MC CORMICK 3302666M92</p>  <p>Height: 2.36 (60) Length: 23.03 (585) Width: 7.09 (180)</p>	<p>AF26154 Freightliner M2 Truck Applications</p> 	<p>AF26166 Safety Element used with AF26168 Filter used with AH19482, AH19486 OptiAir 500 Series Safety Element</p>  <p>Overall Height: 9.92 (252) End 1 OD: 3.05 (78) End 2 OD: 1.44 (37) End 1 ID: 1.89 (48)</p>
<p>AF26142 Used on New Holland Tractor Models 9384, 9484, 9682, 9684, 9882, & 9884</p>  <p>Height: 7.00 (178) Length: 23.03 (585) Width: 7.09 (53)</p>	<p>AF26155 JOHN DEERE AL150288</p> 	<p>AF26167 Safety Element used with AF26116 Filter used with AH19484, AH19496 OptiAir 400 Series Safety Element</p>  <p>Overall Height: 6.35 (161) End 1 OD: 2.41 (61) End 2 OD: 1.72 (44)</p>
<p>AF26143 M.A.N. 81619100018</p>  <p>Height: 2.76 (70) Length: 18.41 (468) Width: 7.87 (200)</p>	<p>AF26156 JOHN DEERE AL150285</p> 	<p>AF26168 Primary Air Filter used with AF26166 Filter used with AH19482, AH19483, AH19486, AH19487 5" OptiAir 500 Series</p>  <p>Overall Height: 10.72 (272) Overall OD: 4.13 (105) End 1 ID: 3.19 (81)</p>
<p>AF26144 MERCEDES-BENZ 9738350147</p>  <p>Height: 1.18 (30) Length: 23.03 (585) Width: 6.85 (174)</p>	<p>AF26157 JOHN DEERE AL119839</p> 	<p>AF26169 CATERPILLAR 8N2555 Used with AF4609 Foam Blanket</p>  <p>Overall Height: 9.50 (241) Overall OD: 20.20 (513) End 1 ID: 19.20 (488)</p>
<p>AF26145 DAF 1362124</p>  <p>Height: 1.77 (45) Length: 10.20 (259) Width: 6.54 (166)</p>	<p>AF26158 FORD 2U2J9601BA Ford 7.3L PowerStroke Applications.</p> 	

E. PRODUCT GUIDE

AF26170 INGERSOLL-RAND 39708466



Overall Height: 5.02 (128)
Overall OD: 10.24 (260)
End 1 ID: 6.10 (155)

AF26172 MERCEDES-BENZ
A0040941804, MERCEDES-
BENZ 40941804



Overall Height: 13.94 (354)
Overall OD: 7.24 (184)
End 1 ID: 4.13 (105)

AF26173 CUMMINS 4946497



Overall Height: 16.30 (414)
End 1 OD: 12.66 (322)
End 2 OD: 12.01 (305)
End 2 ID: 5.91 (150)

AF26174 MERCEDES-BENZ
A9408350047



Height: 1.18 (30)
Length: 17.68 (449)
Width: 7.78 (198)

AF26175 FENDT H311200090100



Overall Height: 13.56 (345)
Overall OD: 7.48 (190)
End 1 ID: 3.74 (95)

AF26176 FENDT H311200090110



Overall Height: 13.29 (338)
End 1 OD: 3.90 (99)
End 2 OD: 3.43 (87)
End 1 ID: 2.84 (72)

AF26178 Applied on John Deere Wheel
Loader 644H



Overall Height: 11.51 (292)
Overall OD: 6.42 (163)
End 1 ID: 3.74 (95)

AF26181 Applied on Caterpillar D6H
Crawlers

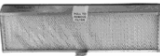

Height: 2.69 (68)
Length: 21.25 (540)
Width: 5.90 (150)

AF26182 JOHN DEERE AT73529



Height: 2.69 (68)
Length: 29.50 (749)
Width: 5.00 (127)

AF26183 MC CORMICK 3233584R2



Height: 1.48 (38)
Length: 13.74 (349)
Width: 5.93 (151)

AF26185 CUMMINS POWER
GENERATION LTD 1403828



Overall Height: 5.59 (142)
Overall OD: 4.96 (126)
End 1 ID: 2.36 (60)

AF26186 CUMMINS POWER
GENERATION LTD 1403829



Overall Height: 5.59 (142)
Overall OD: 4.96 (126)
End 1 ID: 2.36 (60)

AF26187 CUMMINS POWER
GENERATION LTD 1403830



Overall Height: 5.59 (142)
Overall OD: 4.96 (126)
End 1 ID: 2.36 (60)

AF26188 VOLVO 876069



Overall Height: 6.40 (163)
Overall OD: 3.39 (86)
End 1 ID: 1.61 (41)

AF26191 LINDE 9839000 Primary Air
Filter used with AF26192

Overall Height: 11.61 (295)
End 1 OD: 5.20 (132)
End 1 ID: 2.56 (65)

AF26192 LINDE 9839001 Safety
Element used with AF26191



Overall Height: 11.06 (281)
End 1 OD: 2.52 (64)
End 2 OD: 2.40 (61)
End 1 ID: 1.81 (46)

AF26193 NISSAN 16546FJ170 Flame
Retardant Media. Nissan
Forklifts.



Overall Height: 10.78 (274)
Overall OD: 4.13 (105)
End 2 ID: 2.36 (60)

AF26194 CATERPILLAR 4P0711



Overall Height: 14.30 (363)
Flange Diameter: 15.63 (397)
End 1 ID: 10.14 (258)

AF26199 IVECO 2992388



Overall Height: 16.32 (415)
Overall OD: 9.13 (232)
End 1 ID: 5.47 (139)

AF26200 JOHN DEERE RE164839
Primary Air Filter used with
AF26201



Overall Height: 11.59 (295)
Overall OD: 13.07 (332)
End 1 ID: 6.71 (171)

AF26201 JOHN DEERE RE172447
Safety Element used with
AF26200



Overall Height: 10.83 (275)
End 1 OD: 6.89 (175)
End 2 OD: 6.50 (165)
End 1 ID: 5.28 (134)

AF26202 IVECO 42537392

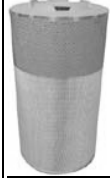

Overall Height: 20.98 (533)
End 1 OD: 10.47 (266)
End 2 OD: 10.51 (267)
End 1 ID: 6.26 (159)

AF26203 GMC 2002268, FORD
1C3Z9601AA



Height: 3.30 (84)
Width: 7.23 (184)

AF26204 IVECO 2992374 Primary Air
Filter used with AF26245
Flame Retardant Media



Overall Height: 19.01 (483)
Overall OD: 12.89 (327)
End 1 ID: 8.58 (218)
End 2 ID: 0.41 (11)

AF26205 FENDT H916201091050
Primary Air Filter used with
AF26206



Overall Height: 18.19 (462)
Overall OD: 11.06 (281)
End 1 ID: 5.91 (150)

AF26206 FENDT H916201091060
Safety Element used with
AF26205



Overall Height: 17.24 (438)
End 1 OD: 5.93 (151)
End 2 OD: 5.59 (142)
End 1 ID: 4.11 (105)

AF26207 NEW HOLLAND 84432503
Primary Air Filter used with
AF26208



Overall Height: 24.92 (633)
Overall OD: 14.15 (360)
End 1 ID: 8.92 (227)

AF26208 NEW HOLLAND 84432504
Safety Element used with
AF26207



Overall Height: 24.61 (625)
End 1 OD: 9.06 (230)
End 2 OD: 8.66 (220)
End 1 ID: 7.01 (178)

E. PRODUCT GUIDE

AF26209 TEREX 15273424 Primary Air Filter used with AF26210

Overall Height: 20.51 (521)
Overall OD: 14.15 (360)
End 1 ID: 8.92 (227)

AF26210 TEREX 15273425 Safety Element used with AF26209



Overall Height: 20.28 (515)
End 1 OD: 9.06 (230)
End 2 OD: 8.66 (220)
End 1 ID: 7.01 (178)

AF26211 VOLKSWAGEN 2S0129620A Safety Element used with AF25997



Overall Height: 16.63 (422)
End 1 OD: 5.63 (143)
End 2 OD: 5.21 (132)
End 1 ID: 4.54 (115)

AF26212 VOLVO 20411816 Safety Element used with AF26163M



Overall Height: 18.46 (469)
Overall OD: 8.38 (213)

AF26213 IVECO 500314688

Height: 1.22 (31)
Length: 11.30 (287)
Width: 6.32 (161)

AF26214 NEW HOLLAND 84072431 Primary Air Filter used with AF26215



Overall Height: 22.95 (583)
Overall OD: 11.06 (281)
End 1 ID: 5.91 (150)

AF26215 NEW HOLLAND 84072430 Safety Element used with AF26214



Overall Height: 22.05 (560)
End 1 OD: 5.93 (151)
End 2 OD: 5.59 (142)
End 1 ID: 4.11 (105)

AF26226 M.A.N. 81779100012



Height: 1.18 (30)
Length: 18.23 (463)
Width: 9.43 (240)

AF26230 KUBOTA 6798082632

Overall Height: 7.09 (180)
Overall OD: 3.27 (83)
End 1 ID: 1.81 (46)
End 2 ID: 1.81 (46)

AF26231 M.A.N. 85619500025



Height: 1.58 (40)
Length: 14.21 (361)
Width: 6.26 (159)

AF26232 CUMMINS POWER GENERATION LTD 1403999



Overall Height: 5.59 (142)
Overall OD: 4.96 (126)
End 1 ID: 2.13 (54)

AF26233 Special PLALLOY Industrial Applications. Is AF4084 w/o gasket

Overall Height: 8.66 (220)
Overall OD: 13.15 (334)
End 1 ID: 8.13 (207)

AF26235 FREIGHTLINER 91559



Height: 0.98 (25)
Length: 10.63 (270)
Width: 10.63 (270)

AF26237 VOLVO PENTA 3827589



Overall Height: 17.30 (440)
End 1 OD: 9.45 (240)
End 2 OD: 8.43 (214)
End 1 ID: 4.69 (119)

AF26241 IVECO 41272124 Flame Retardant Media



Overall Height: 18.15 (461)
End 1 OD: 12.30 (313)
End 2 OD: 12.34 (314)
End 1 ID: 8.07 (205)

AF26242 MERCEDES-BENZ 40943504, MERCEDES-BENZ A0040943504 Flame Retardant Media



Overall Height: 20.98 (533)
End 1 OD: 10.47 (266)
End 2 OD: 10.51 (267)
End 1 ID: 6.26 (159)

AF26244 RENAULT TRUCKS 5001865723 Flame Retardant Media

Overall Height: 18.25 (464)
Overall OD: 12.21 (310)
End 1 ID: 7.07 (180)

AF26245 IVECO 41214149 Safety Element used with AF26204



Overall Height: 18.19 (462)
End 1 OD: 8.27 (210)
End 2 OD: 7.95 (202)
End 1 ID: 7.52 (191)
End 2 ID: .67 (17)

AF26246 M.A.N. 81083040100



Overall Height: 18.90 (480)
End 1 OD: 10.47 (266)
End 2 OD: 10.51 (267)
End 1 ID: 6.26 (159)

AF26247 CATERPILLAR 2277448 Primary Air Filter used with AF26248



Overall Height: 18.90 (480)
End 1 OD: 10.47 (266)
End 2 OD: 10.51 (267)
End 1 ID: 6.26 (159)

AF26248 CATERPILLAR 2277449 Safety Element used with AF26247



Overall Height: 1.75 (45)
End 1 OD: 8.18 (208)
End 2 OD: 5.54 (141)

AF26249 VOLVO PENTA 3827643

Overall Height: 19.11 (486)
Overall OD: 11.93 (303)
End 1 ID: 7.24 (184)

AF26250 KUBOTA T027016321



Overall Height: 9.63 (245)
Overall OD: 4.29 (109)
End 1 ID: 2.26 (58)

AF26253 NELSON 870408N



Overall Height: 6.69 (170)
End 1 OD: 1.77 (45)
End 2 OD: 1.70 (43)

AF26261 M.A.N. 81084050022



Overall Height: 16.34 (415)
Overall OD: 9.13 (232)
End 1 ID: 5.47 (139)

AF26262 M.A.N. 81084050023



Overall Height: 12.01 (305)
Overall OD: 8.94 (227)
End 1 ID: 4.69 (119)

AF26267 VOLVO CONSTRUCTION EQUIPMENT 11703979



Height: 1.73 (44)
Length: 17.09 (434)
Width: 4.80 (122)

AF26268 INTERNATIONAL TRUCKS 3551815C1

Overall Height: 15.96 (405)
End 1 OD: 7.25 (184)
End 2 OD: 4.77 (121)

E. PRODUCT GUIDE

AF26272 RENAULT TRUCKS
5001865725



Overall Height: 21.77 (553)
Overall OD: 12.21 (310)
End 1 ID: 7.07 (180)

AF26275 J.C.B. 32210101



Overall Height: 15.51 (394)
Overall OD: 8.47 (215)
End 1 ID: 4.69 (119)

AF26279 IVECO 41272212



Overall Height: 24.35 (618)
End 1 OD: 12.91 (328)
End 2 OD: 12.89 (328)
End 1 ID: 8.56 (218)
End 2 ID: 0.41 (11)

AF26284 CASE 47107867 Primary Air Filter used with AF26294



Overall Height: 15.04 (382)
Overall OD: 8.19 (208)
End 1 ID: 3.98 (101)

AF26285K HYUNDAI 11EM21041 Primary Air Filter used with AF26286



Overall Height: 19.40 (493)
Boot Diameter: 10.08 (256)
End 2 OD: 7.93 (201)
End 1 ID: 5.33 (135)
End 2 ID: 0.75 (19)

AF26286 HYUNDAI 11EM21051 Safety Element used with AF26285K



Overall Height: 19.37 (492)
Overall OD: 5.16 (131)
End 1 ID: 4.06 (103)
End 2 ID: 0.75 (19)

AF26294 CASE 47107868 Safety Element used with AF26284



Overall Height: 14.35 (365)
End 1 OD: 4.02 (102)
End 2 OD: 3.74 (95)
End 1 ID: 3.19 (81)

AF26296 IVECO 41272515



Overall Height: 20.27 (515)
Overall OD: 12.89 (327)
End 1 ID: 8.58 (218)
End 2 ID: 0.41 (11)

AF26297 CATERPILLAR 1131578

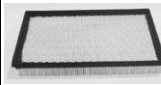

Overall Height: 18.41 (468)
Overall OD: 19.35 (492)
End 1 ID: 12.93 (329)

AF26298 CHRYSLER 53032404AA

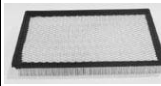

Height: 1.70 (43)
Length: 13.78 (350)
Width: 9.33 (237)

AF26299 GMC 97039002 Mexico only

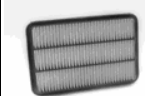

Length: 12.11 (308)
Width: 0.00 (0)

AF26301 CHRYSLER 4306393 Mexico only



Overall Height: 2.72 (69)
Overall OD: 10.00 (254)
End 1 ID: 7.48 (190)
End 2 ID: 7.48 (190)

AF26302 GMC 93425428 Mexico Only



Overall Height: 3.44 (87)
Overall OD: 11.61 (295)
End 1 ID: 9.80 (249)
End 2 ID: 9.80 (249)

AF26303 FORD F50Y9601A Mexico only

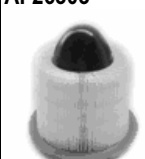

Overall Height: 7.91 (201)
Overall OD: 8.15 (207)
End 1 ID: 4.25 (108)

AF26304 FORD D3Z29601A Mexico only



Overall Height: 1.97 (50)
Overall OD: 10.63 (270)
End 1 ID: 9.09 (231)
End 2 ID: 9.09 (231)

AF26305 GMC 25050385 Mexico only



Overall Height: 2.26 (57)
Overall OD: 8.07 (205)
End 1 ID: 9.65 (245)
End 2 ID: 9.65 (245)

AF26306 FORD E7T29601B Mexico only

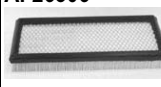

Height: 1.72 (44)
Length: 12.68 (322)
Width: 5.81 (148)

AF26307 CHRYSLER 53004383 Mexico only



Height: 1.54 (39)
Length: 13.39 (340)
Width: 6.61 (168)

AF26308 GMC 25313348 Mexico only



Height: 2.28 (58)
Length: 12.28 (312)
Width: 9.72 (247)

AF26309 GMC 25098463 Mexico only



Height: 1.67 (42)
Length: 11.50 (292)
Width: 5.91 (150)

AF26310 FORD F57Z9601A Mexico only

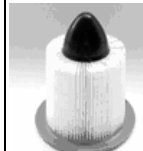

Overall Height: 7.85 (199)
Overall OD: 8.93 (227)
End 1 ID: 3.11 (79)

AF26311 FORD F77Z9601AA Mexico only

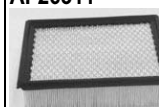

Height: 2.20 (56)
Length: 8.77 (223)
Width: 7.56 (192)

AF26312 GMC 8991386 Mexico only



Overall Height: 2.26 (57)
Overall OD: 8.07 (205)
End 1 ID: 9.69 (246)
End 2 ID: 9.69 (246)

AF26313 FORD E9SZ9601A Mexico only



Height: 1.46 (37)
Length: 9.57 (243)
Width: 9.57 (243)

AF26314 GMC 25042562 Mexico only



Height: 1.74 (44)
Length: 16.00 (406)
Width: 7.95 (202)

AF26315 GMC 15998574 Mexico only



Overall Height: 11.18 (284)
Overall OD: 6.48 (165)
End 1 ID: 3.60 (91)

AF26316 CHRYSLER 3614353 Mexico only



Overall Height: 3.58 (91)
Overall OD: 10.51 (267)
End 1 ID: 8.86 (225)
End 2 ID: 8.86 (225)

AF26317 JEEP 948516 Mexico only















Overall Height: 3.50 (89)
Overall OD: 9.76 (248)

AF26318 FORD XC3Z9601AA Mexico only



Height: 2.48 (63)
Length: 13.40 (340)
Width: 7.24 (184)

E. PRODUCT GUIDE

AF26319  GMC 25168082 Mexico only Overall Height: 11.14 (283) Overall OD: 7.90 (201) End 1 ID: 3.69 (94)	AF26328M Upgrade of AF1968M Used on Kenworth (Paccar) T800 Short Hood Chassis Trucks Overall Height: 22.40 (569) End 1 OD: 11.67 (296) End 2 OD: 10.59 (269) End 2 ID: 6.71 (170)	AF26374 WIX 46807 Height: 3.30 (84) Length: 11.74 (298) Width: 6.79 (172)
AF26320  NISSAN 1654618000 Mexico only Overall Height: 2.01 (51) Overall OD: 8.88 (226) End 1 ID: 6.93 (176) End 2 ID: 6.93 (176)	AF26330 DONALDSON P537355 Overall Height: 24.61 (625) End 1 OD: 9.64 (245) End 2 OD: 9.33 (237) End 1 ID: 5.15 (131)	AF26375 MANN & HUMMEL C4312 Height: 10.43 (265) Length: 13.98 (355) Width: 2.28 (58)
AF26321  NISSAN 16546V0100 Mexico only Height: 1.30 (33) Length: 11.02 (280) Width: 6.61 (168)	AF26336 JOHN DEERE RE210102 Safety Element used with AF26337 Overall Height: 11.73 (298) End 1 OD: 7.17 (182) End 2 OD: 7.11 (181) End 1 ID: 5.79 (147)	AF26384 VOLVO CONSTRUCTION EQUIPMENT 11703980 Height: 2.42 (62) Length: 19.17 (487) Width: 11.26 (286)
AF26322  NISSAN 16546VW600 Mexico only Overall Height: 11.51 (292) Overall OD: 4.86 (123) End 1 ID: 3.25 (83) End 2 ID: 0.67 (17)	AF26337 JOHN DEERE RE210103 Primary Air Filter used with AF26336 Overall Height: 12.67 (322) Overall OD: 12.13 (308) End 1 ID: 7.85 (199)	AF26403 ATLAS COPCO 1613900100MERCEDES-BENZ A0009891311 Overall Height: 3.11 (79) End 1 OD: 3.94 (100) End 1 ID: 2.64 (67)
AF26323  NISSAN 1654686G00 Mexico only Overall Height: 2.33 (59) Overall OD: 12.80 (325)	AF26347 HYUNDAI 28111332510 Overall Height: 6.77 (172) Overall OD: 10.00 (254) End 1 ID: 5.24 (133) End 2 ID: 7.48 (190)	AF26404 DOOSAN INFRACORE EUROPE SA 47400006 Overall Height: 17.85 (454) Overall OD: 11.71 (298) End 1 ID: 0.67 (17) End 2 ID: 7.50 (191)
AF26324  CHRYSLER 53007386 Mexico only Height: 1.46 (37) Length: 11.42 (290) Width: 9.69 (246)	AF26348  YANMAR 11465012591 Overall Height: 2.89 (74) Overall OD: 5.98 (152) End 1 ID: 3.70 (94) End 2 ID: 0.32 (8)	AF26405 VOLVO 20435801 Height: 9.13 (232) Length: 12.28 (312) Width: 1.12 (28)
AF26325 IVECO 41272534 Overall Height: 18.72 (475) End 1 OD: 11.88 (302) End 1 ID: 7.55 (192) End 2 ID: .41 (11)	AF26353  PPM D6550518, TEREX D6550518 Primary Air Filter used with AF25896 Overall Height: 18.90 (480) Overall OD: 9.88 (251) End 1 ID: 6.26 (159)	AF26409 CATERPILLAR 1080688 Height: 0.47 (12) Length: 16.14 (410) Width: 6.30 (160)
AF26326  BALDWIN RS3982 Overall Height: 21.71 (552) Overall OD: 12.91 (328) End 1 ID: 6.87 (175)	AF26355  MERCEDES-BENZ A0008358947, MERCEDES-BENZ 8358947 Height: 0.39 (10) Length: 13.33 (339) Width: 4.96 (126)	AF26415 RENAULT TRUCKS 5001865724 FLAME RETARDANT Overall Height: 14.59 (371) End 1 OD: 9.65 (245) End 2 OD: 9.61 (244) End 1 ID: 4.98 (127)
AF26327  M.A.N. 81084050018 Overall Height: 17.89 (455) Overall OD: 10.04 (255) End 1 ID: 5.10 (130)	AF26356 GENERAL MOTORS 90411732 Overall Height: 1.52 (39) End 1 OD: 8.39 (213) End 2 OD: 6.61 (168) End 1 ID: 7.48 (190) End 2 ID: 7.48 (190)	AF26416 CATERPILLAR 1153634 Overall Height: 14.17 (360) Overall OD: 18.90 (480) End 2 ID: 18.90 (480)
AF26328 Upgrade of AF1968 Used on Kenworth T800 Short Hood Chassis Trucks Overall Height: 22.40 (569) End 1 OD: 11.67 (296) End 2 OD: 10.59 (269) End 2 ID: 6.71 (170)	AF26357  JOHN DEERE RE187966 Height: 1.87 (48) Length: 12.52 (318) Width: 6.48 (165)	AF26417 MACK 57MD317 Overall Height: 22.96 (583) Overall OD: 11.40 (290) End 1 ID: 5.82 (148)
	AF26363 MACK 57MD320M Overall Height: 25.06 (637) Overall OD: 9.33 (237) End 1 ID: 5.80 (147)	AF26418 FORD F6HZ19N619AA Height: 6.10 (155) Length: 8.66 (220) Width: 1.38 (35)
		AF26426 TEREX 15246949 Replaces ST1768 Overall Height: 2.36 (60) Largest OD: 3.78 (96) Thread Size: 3/4-14 BSP AF26427 ALLIANCE ABPN10G36000006 Height: 8.46 (215) Length: 8.46 (215) Width: 0.98 (25)

E. PRODUCT GUIDE

AF26428	ALLIANCE ABPN10G91595
Height:	6.22 (158)
Length:	7.81 (198)
Width:	0.77 (20)
AF26429	ALLIANCE ABPN10G91621
Height:	5.22 (133)
Length:	10.16 (258)
Width:	0.55 (14)
AF26430	IHC 2506656C1
Height:	7.21 (183)
Length:	12.48 (317)
Width:	0.98 (25)
AF26435	MANN & HUMMEL CU2934, VOLVO 8089705
Overall Height:	4.72
Overall Length:	11.42
Overall Width:	1.73
AF26438	JOHN DEERE AH212295
Overall Height:	22.17 (563)
End 1 OD:	7.11 (181)
End 2 OD:	6.57 (167)
AF26446	VOLVO 3948712
Height:	8.39 (213)
Length:	12.40 (315)
Width:	0.71 (18)
AF26447	KENWORTH 525507BSM
Height:	10.04 (255)
Length:	13.78 (350)
Width:	0.70 (18)
AF26448	ALLIANCE 384160
Height:	10.63 (270)
Length:	11.81 (300)
Width:	0.70 (18)
AF26449	PETERBILT 5X010007
Height:	7.68 (195)
Length:	10.83 (275)
Width:	0.70 (18)
AF26450	FORD F65Z19N619AB
Height:	9.05 (230)
Length:	10.09 (256)
Width:	1.12 (28)
AF26451	FORD F6DZ19619BA
Height:	6.77 (172)
Length:	10.43 (265)
Width:	0.98 (25)
AF26458	GMC 88986533
Height:	0.93 (23)
Length:	9.05 (230)
Width:	5.12 (130)
AF26459	GMC 52485513
Length:	9.05 (230)
Width:	5.11 (130)
AF26462	MOPAR 680128766AA 2007 Sprinter Vans
Length:	13.83 (351)
Width:	9.21 (234)

Air Housings

AH1100	CUMMINS 3315741 Disposable Housing Unit
	Overall Height: 15.46 (393) Outlet OD: 5.50 (140) Length: 14.56 (370) Width: 17.38 (442)
AH1101	CUMMINS 3315742 Gen Set Disposable Housing Unit
	Height: 17.91 (455) Outlet OD: 5.50 (140) End 1 OD: 17.64 (448) End 1 ID: 5.50 (140) Length: 17.83 (453) Width: 19.82 (503)
AH1103	Disposable Housing Unit
	Overall Height: 25.72 (653) Largest Housing OD: 11.00 (279) End Connection Height: 1.60 (41) End Connection OD: 7.00 (178)
AH1103F	Same As AH1103 Except Element Inside Is Sitting Off Center.
	
AH1107	DONALDSON HOUSINGS ECC085004 Disposable Housing Unit
	Overall Height: 10.88 (276) Largest Housing OD: 8.50 (216) End Connection Height: 1.38 (35) End Connection ID: 3.00 (76)
AH1135	FARR 71338003 For Upgrade, use AH1135M Disposable Housing Unit
	Overall Height: 25.72 (653) Largest Housing OD: 13.50 (343) End Connection Height: 1.60 (41) End Connection OD: 7.00 (178)
AH1135F	FARR 71338003 For Upgrade, use AH1135M
	
AH1135M	ONAN 1403163, FARR 71338006 Upgrade of AH1135, AH1135F
	Overall Height: 25.72 (653) Largest Housing OD: 13.50 (343) End Connection Height: 1.60 (41) End Connection OD: 7.00 (178)

AH1136	DONALDSON ECB085001 For Marine applications use AH19003 Disposable Housing Unit Use AH19003 for Marine application
	Overall Height: 12.38 (314) Largest Housing OD: 8.50 (216) End Connection Height: 1.38 (35) End Connection ID: 3.00 (76)
AH1138	CUMMINS 3910946, DONALDSON ECC085003 Disposable Housing Unit
	Overall Height: 6.38 (162) Largest Housing OD: 8.50 (216) End Connection Height: 1.38 (35) End Connection ID: 3.00 (76)
AH1139	CUMMINS 3910466, DONALDSON ECB105007 Disposable Housing Unit
	Overall Height: 11.88 (302) Largest Housing OD: 10.50 (267) End Connection Height: 1.38 (35) End Connection ID: 4.00 (102)
AH1140	DONALDSON ECC105003 Disposable Housing Unit
	Overall Height: 7.38 (187) Largest Housing OD: 10.50 (267) End Connection Height: 1.38 (35) End Connection ID: 4.00 (102)
AH1141	CUMMINS 3912020, DONALDSON ECB085011 For Marine applications use AH19002 Disposable Housing Unit For Marine Applications, use AH19002
	Overall Height: 12.38 (314) Largest Housing OD: 8.50 (216) End Connection Height: 1.38 (35) End Connection ID: 4.00 (102)
AH1146	AIR MAZE CDS0916610G Housing used with AF1638, AF1639
	Overall Height w/o Wing Nut: 18.62 (473) Dust collector: YES Largest housing OD: 4.50 (114) End Connection Height: 3.12 (79) End Connection OD: 3.00 (76) Side Connection Loc: 12.75 (324) Side Connection Height: 5.25 (133) Side Connection OD: 3.00 (76)
AH1147	AIR MAZE CDS1017610G, CUMMINS 3834639 Housing used with AF4668, AF963
	Overall Height w/o Wing Nut: 19.62 (498) Dust collector: YES Largest housing OD: 5.25 (133) End Connection Height: 3.12 (79) End Connection OD: 4.00 (102) Side Connection Loc: 13.25 (337) Side Connection Height: 4.63 (117) Side Connection OD: 4.50 (114)

E. PRODUCT GUIDE

<p>AH1148 AIR MAZE CDS1117610G Housing used with AF947, AF963</p>  <p>Overall Height w/o Wing Nut:20.76 (527) Dust collector: YES Largest housing OD: 13.08 (332) End Connection Height: 3.38 (86) End Connection OD: 4.00 (102) Side Connection Loc: 14.11 (358) Side Connection Height:0.52 (13) Side Connection OD: 4.50 (114)</p>	<p>AH1188 DONALDSON ECB085008 Disposable Housing Unit</p>  <p>Overall Height: 9.88 (251) Largest Housing OD: 8.50 (216) End Connection Height: 1.38 (35) End Connection ID: 3.00 (76)</p>	<p>AH1196 Air filter housing package</p>  <p>Overall Height: 11.88 (302) Largest Housing OD: 10.50 (267) End Connection ID: 4.00 (102)</p>
<p>AH1151 AIR MAZE CDS1623610G Housing used with AF4678, AF25218</p>  <p>Overall Height w/o Wing Nut:27.50 (699) Dust collector: YES Largest housing OD: 16.00 (406) End Connection Height: 4.31 (109) End Connection OD: 6.00 (152) Side Connection Loc: 19.00 (483) Side Connection Height:6.00 (152) Side Connection OD: 6.00 (152)</p>	<p>AH1189 THERMO-KING 115978, DONALDSON ECC065008 Disposable Housing Unit</p>  <p>Overall Height: 11.33 (288) Largest Housing OD: 6.64 (169) End Connection Height: 1.38 (35) End Connection ID: 1.40 (36)</p>	<p>AH1197 FARR 114880003</p>  <p>Overall Height: 19.40 (493) Largest housing OD: 10.06 (256) End Connection Height: 1.25 (32) End Connection OD: 5.50 (140) Side Connection Loc: 4.00 (102) Side Connection Height:1.41 (36) Side Connection OD: 6.00 (152)</p>
<p>AH1174 AIR MAZE CD1219650G Housing used with AF4669, AF4670</p>  <p>Overall Ht w/o Wing Nut:21.91(557) Largest Housing OD: 12.62 (321) End Connection Height: 3.35 (85) End Connection OD: 5.00 (127) Side Connection Loc: 14.81 (376) Side Connection Height: 3.69 (94) Side Connection OD: 5.00 (127)</p>	<p>AH1190 DONALDSON HOUSINGS ECC085002 Disposable Housing Unit</p>  <p>Overall Height: 7.88 (200) Largest Housing OD: 8.50 (216) End Connection Height: 1.38 (35) End Connection ID: 2.50 (64)</p>	<p>AH1198 BRODERSON 60012047, DONALDSON HOUSINGS ECC085001</p>  <p>Overall Height: 5.38 (137) Largest Housing OD: 8.50 (216) End Connection Height: 1.38 (35) End Connection ID: 2.50 (64)</p>
<p>AH1183 FARR 71338004 Disposable Housing Unit</p>  <p>Overall Height: 19.72 (501) Largest Housing OD: 13.50 (343) End Connection Height: 1.60 (41) End Connection OD: 7.00 (178)</p>	<p>AH1191 FARR 96896001 Disposable Housing Unit</p>  <p>Overall Height: 14.20 (361) Largest Housing OD: 7.10 (180) End Connection Height: 1.30 (33) End Connection OD: 3.50 (89)</p>	<p>AH1199 ISUZU X14210031, DONALDSON HOUSINGS ECC085006</p>  <p>Overall Height: 10.88 (276) Largest Housing OD: 8.50 (216) End Connection Height: 1.38 (35) End Connection ID: 2.50 (64)</p>
<p>AH1184 FARR 788971 Disposable Housing Unit</p>  <p>Overall Height: 25.35 (644) Largest housing OD: 13.50 (343) End Connection Height: 1.25 (32) End Connection OD: 8.00 (203) Side Connection Loc: 18.62 (473) Side Connection Height:4.37 (111) Side Connection OD: 7.00 (178)</p>	<p>AH1192 FARR 96896002 Disposable Housing Unit</p>  <p>Overall Height: 17.20 (437) Largest Housing OD: 8.10 (206) End Connection Height: 1.30 (33) End Connection OD: 4.50 (114)</p>	<p>AH8500 Outside/In Flow only..</p>  <p>Overall Height: 25.98 (660) Largest housing OD: 9.76 (248) End Connection Height: 1.61 (41) End Connection OD: 5.98 (152) Side Connection Loc: 5.50 (140) Side Connection Height:1.89 (48) Side Connection OD: 5.98 (152)</p>
<p>AH1185 DONALDSON ECB085009 Disposable Housing Unit</p>  <p>Overall Height: 4.38 (111) Largest Housing OD: 8.50 (216) End Connection Height: 1.38 (35) End Connection ID: 3.00 (76)</p>	<p>AH1193 FARR 96896003 Disposable Housing Unit</p>  <p>Overall Height: 20.20 (513) Largest Housing OD: 10.10 (257) End Connection Height: 1.30 (33) End Connection OD: 5.50 (140)</p>	<p>AH8501 FARR 628911 Disposable Housing UnitDual Air Flow</p>  <p>Overall Height: 25.60 (650) Largest housing OD: 9.75 (248) End Connection Height: 1.60 (41) End Connection OD: 6.00 (152) Side Connection Loc: 5.50 (140) Side Connection Height:1.81 (46) Side Connection OD: 6.00 (152)</p>
	<p>AH1194 FARR 71338001 Disposable Housing Unit</p>  <p>Overall Height: 25.72 (653) Largest Housing OD: 9.75 (248) End Connection Height: 1.60 (41) End Connection OD: 6.00 (152)</p>	<p>AH8502 Outside/In Flow only</p>  <p>Overall Height: 26.00 (660) Largest Housing OD: 11.00 (279) End Connection Height: 1.61 (41) End Connection OD: 7.00 (178)</p>
	<p>AH1195 FARR 71338005 Disposable Housing Unit</p>  <p>Overall Height: 16.70 (424) Largest Housing OD: 13.50 (343) End Connection Height: 1.60 (41) End Connection OD: 7.00 (178)</p>	<p>AH8503 FARR 62891002 Disposable Air HousingDual Air Flow</p>  <p>Overall Height: 25.60 (650) Largest housing OD: 11.00 (279) End Connection Height: 1.60 (41) End Connection OD: 7.00 (178) Side Connection Loc: 5.50 (140) Side Connection Height:1.91 (49) Side Connection OD: 7.00 (178)</p>

E. PRODUCT GUIDE

<p>AH8504 Outside/In Flow only</p>  <p>Overall Height: 25.98 (660) Largest housing OD: 13.50 (343) End Connection Height: 1.61 (41) End Connection OD: 7.00 (178) Side Connection Loc: 5.50 (140) Side Connection Height: 2.25 (57) Side Connection OD: 7.00 (178)</p>	<p>AH19004 CUMMINS 3924541, DONALDSON ECB105013 For non-Marine applications, use AH19037 Marine applied Cummins B & C engines</p>  <p>Overall Height: 11.88 (302) Largest Housing OD: 10.50 (267) End Connection Height: 1.38 (35) End Connection ID: 4.00 (102)</p>	<p>AH19053 DONALDSON ECC065015</p>  <p>Overall Height: 10.38 (264) Largest Housing OD: 6.50 (165) End Connection Height: 1.38 (35) End Connection ID: 2.00 (51)</p>
<p>AH8505 FARR 628913 Disposable Air HousingDual Air Flow</p>  <p>Overall Height: 25.60 (650) Largest housing OD: 13.50 (343) End Connection Height: 1.60 (41) End Connection OD: 7.00 (178) Side Connection Loc: 5.50 (140) Side Connection Height: 1.91 (49) Side Connection OD: 7.00 (178)</p>	<p>AH19014 FARR 99842009 Motor Homes</p>  <p>Overall Height: 16.72 (425) Largest housing OD: 13.50 (343) End Connection Height: 1.60 (41) End Connection OD: 7.00 (178) Side Connection Loc: 5.62 (143) Side Connection Height: 1.87 (47) Side Connection OD: 7.00 (178)</p>	<p>AH19056 FARR 400028001</p>  <p>Overall Height: 25.72 (653) Largest Housing OD: 11.00 (279) End Connection Height: 1.60 (41) End Connection OD: 7.00 (178)</p>
<p>AH8513 DONALDSON ECB125011</p>  <p>Overall Height: 10.28 (261) Largest Housing OD: 12.44 (316) End Connection Height: 1.30 (33) End Connection ID: 4.94 (126)</p>	<p>AH19015 FARR 99842010 Motor Homes w/Cummins Eng.</p>  <p>Overall Height: 16.72 (425) Largest housing OD: 13.50 (343) End Connection Height: 1.60 (41) End Connection OD: 7.00 (178) Side Connection Loc: 9.62 (244) Side Connection Height: 1.87 (47) Side Connection OD: 7.00 (178)</p>	<p>AH19057 FARR 114880005</p>  <p>Overall Height: 17.20 (437) Largest housing OD: 8.12 (206) End Connection Height: 1.25 (32) End Connection OD: 4.50 (114) Side Connection Loc: 5.50 (140) Side Connection Height: 1.38 (35) Side Connection OD: 6.00 (152)</p>
<p>AH8742 CUMMINS POWER GENERATION LTD 1403550</p>  <p>Overall Height: 6.65 (169) Housing OD: 6.29 (160) End Opening ID: 3.00 (76)</p>	<p>AH19036 CUMMINS 3630751 Housing used with AF25278 Uses service part: 3836953S, 3918236S, 3951391S For Cummins gensets with KT/KTA/KTTA & VTA engines</p>  <p>Overall Height: 16.02 (407) Outlet OD: 7.01 (178) Length: 21.10 (536) Width: 17.50 (444)</p>	<p>AH19061 Housing used with AF1823K Uses service part: 3918201S, 3918219S, Q04190, Q56825, Q56828, Q59111, Q80533</p>  <p>Overall Height w/o Wing Nut: 16.90 (429) Dust collector: YES Largest housing OD: 5.25 (133) End Connection Height: 2.00 (51) End Connection OD: 2.50 (64) Side Connection Loc: 13.15 (334) Side Connection Height: 1.50 (38) Side Connection OD: 2.50 (64)</p>
<p>AH19000 CATERPILLAR 310011 Donaldson ECC05-5003</p>  <p>Overall Height: 5.38 (137) Largest Housing OD: 5.50 (140) End Connection Height: 1.38 (35) End Connection ID: 1.75 (44)</p>	<p>AH19037 DONALDSON ECB105006 For Marine applications use AH19004 Disposable Housing Unit</p>  <p>Overall Height: 11.88 (302) Largest Housing OD: 10.50 (267) End Connection Height: 1.38 (35) End Connection ID: 4.00 (102)</p>	<p>AH19062 Housing used with AF1823K, AF1824 Uses service part: 3918201S, 3918219S, Q04190, Q56825, Q56828, Q59111, Q80533</p>  <p>Overall Height w/o Wing Nut: 16.90 (429) Dust collector: YES Largest housing OD: 5.25 (133) End Connection Height: 2.00 (51) End Connection OD: 2.50 (64) Side Connection Loc: 13.15 (334) Side Connection Height: 1.50 (38) Side Connection OD: 2.50 (64)</p>
<p>AH19001 DONALDSON ECC045001, CATERPILLAR 8X4575</p>  <p>Overall Height: 5.88 (149) Largest Housing OD: 4.50 (114) End Connection Height: 1.38 (35) End Connection ID: 1.50 (38)</p>	<p>AH19040 ONAN 1403112 Housing used with AF947, 1403117</p>  <p>Overall Height w/o Wing Nut: 21.56 (548) Dust collector: YES Largest housing OD: 10.98 (279) End Connection Height: 3.88 (99) End Connection OD: 4.13 (105) Side Connection Loc: 14.41 (366) Side Connection Height: 4.67 (119) Side Connection OD: 4.49 (114)</p>	<p>AH19063 Housing used with AF1606KM Uses service part: 3918202S, 3918220S, Q04192, Q56825, Q56828, Q59111</p>  <p>Overall Height w/o Wing Nut: 17.65 (448) Dust collector: YES Largest housing OD: 6.55 (166) End Connection Height: 2.00 (51) End Connection OD: 3.00 (76) Side Connection Loc: 13.84 (352) Side Connection Height: 1.50 (38) Side Connection OD: 3.00 (76)</p>
<p>AH19002 CUMMINS 3924540, DONALDSON ECB085024 For non-Marine applications, use AH1141 Marine applied Cummins B & C engines.</p>  <p>Overall Height: 12.38 (314) Largest Housing OD: 8.50 (216) End Connection Height: 1.38 (35) End Connection ID: 4.00 (102)</p>	<p>AH19042 Disposable Housing Unit</p>  <p>Overall Height: 16.38 (416) Largest Housing OD: 12.50 (318) End Connection Height: 1.38 (35) End Connection ID: 6.00 (152)</p>	
<p>AH19003 CUMMINS 3924893 For non-Marine applications, use AH1136 Marine applied B & C Engines</p>  <p>Overall Height: 12.38 (314) Largest Housing OD: 8.50 (216) End Connection Height: 1.38 (35) End Connection ID: 3.00 (76)</p>		

E. PRODUCT GUIDE

AH19064



Housing used with AF1606KM, AF1892 Uses service part: 3918202S, 3918220S, Q04192, Q56825, Q56828, Q59111

Overall Height w/o Wing Nut: 17.65 (448)
Dust collector: YES
Largest housing OD: 6.55 (166)
End Connection Height: 2.00 (51)
End Connection OD: 3.00 (76)
Side Connection Loc: 13.84 (352)
Side Connection Height: 1.50 (38)
Side Connection OD: 3.00 (76)

AH19065



Housing used with AF4059K Uses service part: 3918203S, 3918222S, Q04194, Q06316, Q56825, Q56828, Q80534

Overall Height w/o Wing Nut: 18.05 (458)
Dust collector: YES
Largest housing OD: 7.89 (200)
End Connection Height: 2.50 (64)
End Connection OD: 3.50 (89)
Side Connection Loc: 13.11 (333)
Side Connection Height: 1.50 (38)
Side Connection OD: 3.75 (95)

AH19066



Housing used with AF4059K, AF4103 Uses service part: 3918203S, 3918222S, Q04194, Q06316, Q56825, Q56828, Q80534

Overall Height w/o Wing Nut: 18.05 (458)
Dust collector: YES
Largest housing OD: 7.89 (200)
End Connection Height: 2.50 (64)
End Connection OD: 3.50 (89)
Side Connection Loc: 13.11 (333)
Side Connection Height: 1.50 (38)
Side Connection OD: 3.75 (95)

AH19067



Housing used with AF434KM Uses service part: 3918205S, 3918227S, Q01453, Q04196, Q06316, Q32418, Q56268

Overall Height w/o Wing Nut: 20.24 (514)
Dust Collector: Yes
Largest Housing OD: 10.27 (261)
End Connection Height: 3.50 (89)
End Connection OD: 5.00 (127)
Side Connection Loc: 13.49 (343)
Side Connection Height: 3.09 (78)
Side Connection OD: 5.00 (127)

AH19068



Housing used with AF434KM, AF804M Uses service part: 3918205S, 3918227S, Q01453, Q04196, Q06316, Q32418, Q56268

Overall Height w/o Wing Nut: 20.24 (514)
Dust Collector: Yes
Largest Housing OD: 10.27 (261)
End Connection Height: 3.50 (89)
End Connection OD: 5.00 (127)
Side Connection Loc: 13.49 (343)
Side Connection Height: 3.09 (78)
Side Connection OD: 5.00 (127)

AH19069



Uses service part: 3918205S, 3918231S, Q01453, Q04199, Q06316, Q56268
Replacement filter: AF418M

Overall Height w/o Wing Nut: 18.48 (469)
Dust collector: YES
Largest housing OD: 12.07 (307)
End Connection Height: 3.50 (89)
End Connection OD: 5.00 (127)
Side Connection Loc: 9.73 (247)
Side Connection Height: 3.09 (78)
Side Connection OD: 5.00 (127)

AH19070



Housing used with AF418M, AF490M Uses service part: 3918205S, 3918231S, Q01453, Q04199, Q06316, Q56268

Overall Height w/o Wing Nut: 17.44 (443)
Dust collector: YES
Largest housing OD: 12.07 (307)
End Connection Height: 3.50 (89)
End Connection OD: 5.00 (127)
Side Connection Loc: 9.75 (248)
Side Connection Height: 2.24 (57)
Side Connection OD: 5.00 (127)

AH19072



Housing used with AF820M, AF424M Uses service part: 3918206S, 3918234S, Q01453, Q04223, Q06316, Q56268

Overall Height w/o Wing Nut: 21.23 (539)
Dust Collector: Yes
Largest Housing OD: 14.00 (356)
End Connection Height: 2.97 (75)
End Connection OD: 6.00 (152)
Side Connection Loc: 11.98 (304)
Side Connection Height: 3.83 (97)
Side Connection OD: 6.00 (152)

AH19073



Housing used with AF4553M Uses service part: 3918236S, Q06316, Q56855

Overall Height w/o Wing Nut: 24.64 (626)
Dust collector: YES
Largest housing OD: 16.10 (409)
End Connection Height: 2.00 (51)
End Connection OD: 7.00 (178)
Side Connection Height: 1.95 (50)
Side Connection OD: 7.00 (178)

AH19074



Housing used with AF4553M, AF4554M Uses service part: 3918236S, 3918242S, Q06316, Q56855

Overall Height w/o Wing Nut: 24.64 (626)
Dust collector: YES
Largest housing OD: 16.10 (409)
End Connection Height: 2.00 (51)
End Connection OD: 7.00 (178)
Side Connection Height: 1.95 (50)
Side Connection OD: 7.00 (178)

AH19075



Housing used with AF25544 Uses service part: 3918237S, Q01428, Q06316

Overall Height w/o Wing Nut: 28.96 (736)
Dust collector: YES
Largest housing OD: 18.12 (460)
End Connection Height: 3.00 (76)
End Connection OD: 8.00 (203)
Side Connection Loc: 20.40 (518)
Side Connection Height: 2.44 (62)
Side Connection OD: 10.00 (254)

AH19076



Housing used with AF25544, AF25545 Uses service part: 3918237S, 3918244S, Q01428, Q06316

Overall Height w/o Wing Nut: 28.96 (736)
Dust collector: YES
Largest housing OD: 18.12 (460)
End Connection Height: 3.00 (76)
End Connection OD: 8.00 (203)
Side Connection Loc: 20.40 (518)
Side Connection Height: 2.44 (62)
Side Connection OD: 10.00 (254)

AH19078



Housing used with AF25547 Uses service part: 3918224S, Q56828, Q80693

Overall Height w/o Wing Nut: 21.54 (547)
Largest housing OD: 8.52 (216)
End Connection Height: 2.56 (65)
End Connection OD: 5.00 (127)
Side Connection Loc: 7.17 (182)
Side Connection Height: 2.51 (64)
Side Connection OD: 5.00 (127)

AH19079



Housing used with AF25548 Uses service part: 3918226S, Q56825, Q56828, Q80695

Overall Height w/o Wing Nut: 22.96 (583)
Largest housing OD: 10.10 (257)
End Connection Height: 3.06 (78)
End Connection OD: 6.00 (152)
Side Connection Loc: 5.45 (138)
Side Connection Height: 2.59 (66)
Side Connection OD: 6.00 (152)

AH19080



Housing used with AF25549 Uses service part: 3918230S, Q56828, Q80697

Overall Height w/o Wing Nut: 22.96 (583)
Largest housing OD: 11.81 (300)
End Connection Height: 3.20 (81)
End Connection OD: 6.00 (152)
Side Connection Loc: 5.26 (134)
Side Connection Height: 4.14 (105)
Side Connection OD: 7.00 (178)













AH19081



Housing used with AF25550 Uses service part: 3918199S, Q06470, Q760311, Q760311

Side Opening Offset: 1.43 (36)
Overall Height: 9.65 (245)
Dust collector: YES
Largest housing OD: 5.28 (134)
End Connection OD: 1.75 (44)
Side Connection Loc: 5.97 (152)
Side Connection Height: 0.61 (15)
Side Connection OD: 1.75 (44)

E. PRODUCT GUIDE

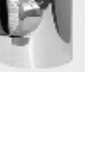
<p>AH19082</p>  <p>Housing used with AF25550 Uses service part: 3918199S, Q06470, Q760311</p> <p>Side Opening Offset: 1.43 (36) Overall Height: 9.62 (244) Dust collector: YES Largest housing OD: 5.28 (134) End Connection OD: 1.75 (44) Side Connection Loc: 5.97 (152) Side Connection Height: 0.61 (15) Side Connection OD: 1.75 (44)</p>	<p>AH19088</p>  <p>Housing used with AF25553, AF25554 Uses service part: 3918196S, Q06470</p> <p>Side Opening Offset: 2.06 (52) Overall Height: 14.78 (375) Dust collector: YES Largest housing OD: 6.68 (170) End Connection OD: 2.50 (64) Side Connection Loc: 10.80 (274) Side Connection Height: 1.07 (27) Side Connection OD: 2.50 (64)</p>	<p>AH19094</p>  <p>Housing used with AF25556, AF25555 Uses service part: Q06470, Q206002</p> <p>Side Opening Offset: 1.98 (50) Overall Height: 17.38 (441) Dust collector: YES Largest housing OD: 8.10 (206) End Connection OD: 3.00 (76) Side Connection Loc: 11.41 (290) Side Connection Height: 0.83 (21) Side Connection OD: 3.00 (76)</p>
<p>AH19083</p>  <p>Housing used with AF25551 Uses service part: 3918198S, Q06470, Q760311</p> <p>Side Opening Offset: 1.75 (44) Overall Height: 13.20 (335) Dust collector: YES Largest housing OD: 6.24 (158) End Connection OD: 2.00 (51) Side Connection Loc: 9.27 (235) Side Connection Height: 0.70 (18) Side Connection OD: 2.00 (51)</p>	<p>AH19089</p>  <p>Housing used with AF25553 Uses service part: Q06470</p> <p>Side Opening Offset: 2.06 (52) Overall Height: 16.19 (411) Dust collector: YES Largest housing OD: 6.68 (170) End Connection OD: 2.50 (64) Side Connection Loc: 10.80 (274) Side Connection Height: 1.07 (27) Side Connection OD: 2.50 (64)</p>	<p>AH19095</p>  <p>Housing used with AF25557 Uses service part: 3918197S</p> <p>Side Opening Offset: 2.23 (57) Overall Height: 16.23 (412) Dust collector: YES Largest housing OD: 9.26 (235) End Connection OD: 3.50 (89) Side Connection Loc: 12.02 (305) Side Connection Height: 0.80 (20) Side Connection OD: 3.75 (95)</p>
<p>AH19084</p>  <p>NELSON 75584N Housing used with AF25551, AF25552 Uses service part: 3918198S, Q06470, Q760311</p> <p>Side Opening Offset: 1.75 (44) Overall Height: 13.18 (335) Dust collector: YES Largest housing OD: 6.24 (158) End Connection OD: 2.00 (51) Side Connection Loc: 9.27 (235) Side Connection Height: 0.70 (18) Side Connection OD: 2.00 (51)</p>	<p>AH19090</p>  <p>NELSON 765010N Housing used with AF25554, AF25553 Uses service part: 3918196S, Q06470</p> <p>Side Opening Offset: 2.06 (52) Overall Height: 16.19 (411) Dust collector: YES Largest housing OD: 6.68 (170) End Connection OD: 2.50 (64) Side Connection Loc: 10.80 (274) Side Connection Height: 1.07 (27) Side Connection OD: 2.50 (64)</p>	<p>AH19096</p>  <p>Housing used with AF25557, AF25558 Uses service part: 3918197S</p> <p>Side Opening Offset: 2.23 (57) Overall Height: 16.23 (412) Dust collector: YES Largest housing OD: 9.26 (235) End Connection OD: 3.50 (89) Side Connection Loc: 12.02 (305) Side Connection Height: 0.80 (20) Side Connection OD: 3.75 (95)</p>
<p>AH19085</p>  <p>NELSON 75591N Housing used with AF25551 Uses service part: 3918198S, Q06470, Q760311</p> <p>Side Opening Offset: 1.75 (44) Overall Height: 14.14 (359) Dust collector: YES Largest housing OD: 6.24 (158) End Connection OD: 2.00 (51) Side Connection Loc: 9.27 (235) Side Connection Height: 0.70 (18) Side Connection OD: 2.00 (51)</p>	<p>AH19091</p>  <p>Housing used with AF25555 Uses service part: Q06470, Q206002</p> <p>Side Opening Offset: 1.98 (50) Overall Height: 15.46 (393) Dust collector: YES Largest housing OD: 8.10 (206) End Connection OD: 3.00 (76) Side Connection Loc: 11.41 (290) Side Connection Height: 0.83 (21) Side Connection OD: 3.00 (76)</p>	<p>AH19097</p>  <p>Housing used with AF25557 Uses service part: 3918197S</p> <p>Side Opening Offset: 2.23 (57) Overall Height: 18.63 (473) Dust collector: YES Largest housing OD: 9.26 (235) End Connection OD: 3.50 (89) Side Connection Loc: 12.02 (305) Side Connection Height: 0.80 (20) Side Connection OD: 3.75 (95)</p>
<p>AH19086</p>  <p>Housing used with AF25551, AF25552 Uses service part: 3918198S, Q06470, Q760311</p> <p>Side Opening Offset: 1.75 (44) Overall Height: 14.14 (359) Dust collector: YES Largest housing OD: 6.24 (158) End Connection OD: 2.00 (51) Side Connection Loc: 9.27 (235) Side Connection Height: 0.70 (18) Side Connection OD: 2.00 (51)</p>	<p>AH19092</p>  <p>Housing used with AF25555, AF25556 Uses service part: Q06470, Q206002</p> <p>Side Opening Offset: 1.98 (50) Overall Height: 15.46 (393) Dust collector: YES Largest housing OD: 8.10 (206) End Connection OD: 3.00 (76) Side Connection Loc: 11.41 (290) Side Connection Height: 0.83 (21) Side Connection OD: 3.00 (76)</p>	<p>AH19098</p>  <p>Housing used with AF25557, AF25558 Uses service part: 3918197S</p> <p>Side Opening Offset: 2.23 (57) Overall Height: 18.63 (473) Dust collector: YES Largest housing OD: 9.26 (235) End Connection OD: 3.50 (89) Side Connection Loc: 12.02 (305) Side Connection Height: 0.80 (20) Side Connection OD: 3.75 (95)</p>
<p>AH19087</p>  <p>Housing used with AF25553 Uses service part: 3918196S, Q06470</p> <p>Side Opening Offset: 2.06 (52) Overall Height: 14.76 (375) Dust collector: YES Largest housing OD: 6.68 (170) End Connection OD: 2.50 (64) Side Connection Loc: 10.80 (274) Side Connection Height: 1.07 (27) Side Connection OD: 2.50 (64)</p>	<p>AH19093</p>  <p>Housing used with AF25555 Uses service part: Q06470, Q206002</p> <p>Side Opening Offset: 1.98 (50) Overall Height: 17.38 (441) Dust collector: YES Largest housing OD: 8.10 (206) End Connection OD: 3.00 (76) Side Connection Loc: 11.41 (290) Side Connection Height: 0.83 (21) Side Connection OD: 3.00 (76)</p>	<p>AH19099</p>  <p>Housing used with AF954M Uses service part: Q01368, Q79002</p> <p>Overall Height: 30.10 (765) Largest housing OD: 12.38 (314) End Connection OD: 7.00 (178) Side Connection Loc: 8.00 (203) Side Connection Height: 1.81 (46) Side Connection OD: 6.00 (152)</p>

E. PRODUCT GUIDE

AH19100



Housing used with AF954M
Uses service part: Q01368,
Q79002

Overall Height: 30.10 (765)
Largest housing OD: 12.38 (314)
End Connection OD: 7.00 (178)
Side Connection Loc: 8.00 (203)
Side Connection Height: 1.81 (46)
Side Connection OD: 6.00 (152)

AH19104



Housing used with AF1616
Uses service part: Q01368

Overall Height: 32.95 (837)
Largest housing OD: 13.20 (335)
Side Connection Loc: 18.44 (468)
Side Connection Height: 3.60 (91)
Side Connection OD: 6.00 (152)

AH19106



Housing used with AF1616
Uses service part: Q01368

Overall Height: 32.95 (837)
Largest housing OD: 13.20 (335)
Side Connection Loc: 18.44 (468)
Side Connection Height: 3.82 (97)
Side Connection OD: 6.00 (152)

AH19107



Housing used with AF1658K
Uses service part: 3918218S,
Q04188, Q33456, Q56880,
Q59111

Overall Height w/o Wing Nut: 8.50
(216)
Dust collector: YES
Largest housing OD: 4.57 (116)
End Connection Height: 1.00 (25)
End Connection OD: 1.75 (44)
Side Connection Loc: 6.00 (152)
Side Connection Height: 1.21 (31)
Side Connection OD: 1.75 (44)

AH19108



Housing used with AF25543K
Uses service part: 3918200S,
3918219S, Q04190, Q56825,
Q56828, Q59111, Q80661

Overall Height w/o Wing Nut: 12.85
(326)
Dust collector: YES
Largest housing OD: 5.25 (133)
End Connection Height: 2.00 (51)
End Connection OD: 2.00 (51)
Side Connection Loc: 9.35 (237)
Side Connection Height: 1.50 (38)
Side Connection OD: 2.00 (51)

AH19109



Housing used with AF437KM,
AF437K Uses service part:
3918201S, 3918220S,
Q04192, Q56825, Q56828,
Q59111

Overall Height w/o Wing Nut: 13.65
(347)
Dust collector: YES
End Connection Height: 2.00 (51)
End Connection OD: 2.25 (57)
Side Connection Loc: 1.81 (46)
Side Connection OD: 2.50 (64)

AH19110



Housing used with AF409KM,
AF409K Uses service part:
3918202S, 3918222S,
Q04194, Q06316, Q56825,
Q56828, Q80534

Overall Height w/o Wing Nut: 14.50
(368)
Dust collector: YES
Largest housing OD: 7.89 (200)
End Connection Height: 2.00 (51)
End Connection OD: 3.00 (76)
Side Connection Loc: 10.44 (265)
Side Connection Height: 1.50 (38)
Side Connection OD: 3.00 (76)

AH19113



Overall Height w/o Wing Nut: 28.28
(718)
Largest housing OD: 16.00 (406)
End Connection Height: 3.87 (98)
End Connection OD: 7.00 (178)
Side Connection Height: 2.25 (-57)
Side Connection OD: 7.00 (178)

AH19115



CUMMINS 4001508 Housing
used with AF25593

Overall Height: 16.04 (408)
Outlet OD: 6.89 (175)
Length: 26.85 (682)
Width: 16.04 (408)

AH19220



DONALDSON HOUSINGS
ECC125004

Overall Height: 12.38 (314)
Largest Housing OD: 12.50 (318)
End Connection Height: 1.38 (35)
End Connection ID: 5.00 (127)

AH19222



FARR 117122000

Overall Height: 25.60 (650)
Largest Housing OD: 11.50 (292)
End Connection Height: 1.60 (41)
End Connection OD: 7.50 (191)

AH19223



Overall Height: 16.72 (425)
Largest housing OD: 13.50 (343)
End Connection Height: 1.60 (41)
End Connection OD: 7.00 (178)
Side Connection Loc: 9.50 (241)
Side Connection Height: 1.85 (47)
Side Connection OD: 7.00 (178)

AH19228



INGERSOLL-RAND 8524575,
DONALDSON D045003

Overall Height: 5.88 (149)
Largest Housing OD: 4.50 (114)
End Connection Height: 1.38 (35)
End Connection ID: 1.50 (38)

AH19232



DONALDSON HOUSINGS
ECC065002

Overall Height: 8.88 (226)
Largest Housing OD: 6.50 (165)
End Connection Height: 1.38 (35)
End Connection ID: 2.00 (51)

AH19257



CUMMINS 140328801
Housing used with AF25708M
Uses service part: 3935421S

Overall Height: 23.81 (605)
Largest Housing OD: 14.11 (358)
End Connection Height: 3.13 (80)
End Connection OD: 7.13 (181)

AH19258

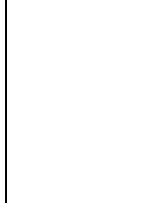

NEOPLAN J020200 Air
Housing with no Dust Collector

Overall Height w/o Wing Nut: 22.96
(583)
Largest housing OD: 14.10 (358)
End Connection Height: 2.45 (62)
End Connection OD: 7.00 (178)
Side Connection Loc: 15.25 (387)
Side Connection Height: 0.00 (0)
Side Connection OD: 7.00 (178)

AH19259



Housing used with AF1828,
AF1894M Air Housing with
Dust Collector

Overall Height w/o Wing Nut: 25.05
(636)
Dust collector: YES
Largest housing OD: 14.10 (358)
End Connection Height: 3.00 (76)
End Connection OD: 6.00 (152)
Side Connection Loc: 3.75 (95)
Side Connection Height: 3.00 (-76)
Side Connection OD: 6.00 (152)

AH19260



Housing used with AF25960,
AF25961 Uses service part:
3946462S OptiAir 800 Series
Air Housing Systems. 8"
plastic, w/safety, straight.

Overall Height: 14.49 (368)
Largest housing OD: 9.21 (234)
End Connection OD: 4.00 (102)
Side Connection OD: 3.75 (95)

AH19261



Housing used with AF25960
Uses service part: 3946462S
OptiAir 800 Series Air Housing
Systems. 8" plastic, w/o
safety, straight.

Overall Height: 14.49 (368)
Largest housing OD: 9.21 (234)
End Connection OD: 4.00 (102)
Side Connection OD: 3.75 (95)

AH19266



Housing used with AF25708M
Uses service part: 3935422S
Similar to the AH19257 with
flame retardant material

Overall Height: 23.81 (605)
Largest Housing OD: 14.11 (358)
End Connection Height: 3.13 (80)
End Connection OD: 7.13 (181)

E. PRODUCT GUIDE

AH19267



Housing used with AF1733K, AF4103

Overall Height w/o Wing Nut:18.51 (470)
Dust collector: YES
Largest housing OD: 7.89 (200)
End Connection Height: 2.50 (64)
End Connection OD: 3.50 (89)
Side Connection Loc: 2.44 (62)
Side Connection Height:0.00 (0)
Side Connection OD: 3.75 (95)

AH19268

Housing used with AF1733K

Overall Height w/o Wing Nut:18.51 (470)
Dust collector: YES
Largest housing OD: 7.89 (200)
End Connection Height: 2.50 (64)
End Connection OD: 3.50 (89)
Side Connection Loc: 2.44 (62)
Side Connection Height:0.00 (0)
Side Connection OD: 3.75 (95)

AH19269



Overall Height w/o Wing Nut:19.80 (503)
Dust collector: YES
Largest housing OD: 9.47 (241)
End Connection Height: 2.40 (61)
End Connection OD: 4.00 (102)
Side Connection Loc: 2.70 (69)
Side Connection Height:2.20 (-56)
Side Connection OD: 4.00 (102)

AH19270



Overall Height w/o Wing Nut:19.80 (503)
Dust collector: YES
Largest housing OD: 8.95 (227)
End Connection Height: 2.40 (61)
End Connection OD: 4.00 (102)
Side Connection Loc: 2.70 (69)
Side Connection Height:1.94 (-49)
Side Connection OD: 4.00 (102)

AH19271



Overall Height w/o Wing Nut:21.90 (556)
Dust collector: YES
Largest housing OD: 11.81 (300)
End Connection Height: 3.46 (88)
End Connection OD: 5.00 (127)
Side Connection Loc: 14.94 (379)
Side Connection Height:2.87 (73)
Side Connection OD: 6.00 (152)

AH19272



Housing used with AF4754

Overall Height w/o Wing Nut:21.90 (556)
Dust collector: YES
Largest housing OD: 11.81 (300)
End Connection Height: 3.46 (88)
End Connection OD: 5.00 (127)
Side Connection Loc: 14.94 (379)
Side Connection Height:2.87 (73)
Side Connection OD: 6.00 (152)

AH19273



Housing used with AF25708M
Uses service part: 3936445S

Overall Height: 23.95 (608)
Largest Housing OD: 14.11 (358)
End Connection Height: 3.13 (80)
End Connection OD: 7.13 (181)

AH19274



Housing used with AF25708M
Uses service part: 3936445S

Side Opening Offset: 3.58 (91)
Overall Height: 23.95 (608)
Largest housing OD: 14.11 (358)
End Connection OD: 7.00 (178)
Side Connection Loc: 7.50 (191)
Side Connection Height:1.20 (30)
Side Connection OD: 8.00 (203)

AH19322



CUMMINS 4090571 Housing
used with AF947

Height: 17.67 (449)
Overall OD: 11.18 (284)

AH19323



Housing used with AF25877,
AF25878

Overall Height w/o Wing Nut:23.31 (592)
Dust collector: YES
Largest housing OD: 14.02 (356)
End Connection Height: 1.50 (38)
End Connection OD: 5.51 (140)
Side Connection Loc: 17.62 (447)
Side Connection Height:6.99 (178)
Side Connection OD: 6.00 (152)

AH19324



Housing used with AF4674,
AF4675

Overall Height w/o Wing Nut:30.62 (778)
Dust collector: YES
Largest housing OD: 16.00 (406)
End Connection Height: 2.24 (57)
End Connection OD: 6.00 (152)
Side Connection Loc: 23.64 (600)
Side Connection Height:5.00 (127)
Side Connection OD: 7.00 (178)

AH19325



CUMMINS 3103261 Housing
used with AF928M perforated
lid, no side connection

Overall Height: 18.95 (481)
Largest Housing OD: 15.95 (405)
End Connection Height: 1.50 (38)
End Connection ID: 5.50 (140)

AH19326



CUMMINS 3103262 Housing
used with AF928M side
connection

Overall Height: 18.94 (481)
Largest housing OD: 15.95 (405)
End Connection Height: 1.42 (36)
End Connection OD: 5.62 (143)
Side Connection Loc: 12.76 (324)
Side Connection Height:4.78 (121)
Side Connection OD: 7.00 (178)

AH19327



CUMMINS 4095069 Housing
used with AF872

Overall Height: 20.81 (529)
Largest housing OD: 16.00 (406)
End Connection Height: 2.50 (64)
End Connection OD: 7.00 (178)
Side Connection Loc: 12.99 (330)
Side Connection Height:4.99 (127)
Side Connection OD: 8.00 (203)

AH19330



Housing used with AF25959 5"
Opti-Air

Overall Height: 13.19 (335)
Housing OD: 6.24 (158)
End Opening ID: 2.00 (51)
Width: 7.55 (192)

AH19331

Housing used with AF25960,
AF25961 8" Opti-Air 600
Series

Overall Height: 16.19 (411)
Housing OD: 9.25 (235)
End Opening ID: 4.00 (102)
Width: 10.08 (256)

AH19332



Housing used with AF25960 8"
OptiAir 600 Series

Overall Height: 16.19 (411)
Housing OD: 9.25 (235)
End Opening ID: 4.00 (102)
Width: 10.08 (256)

AH19333



Housing used with AF25962
Uses service part: 3946465S
OptiAir 1100 Series. 11"
plastic, w/o safety, straight.

Overall Height: 19.00 (480)
Housing OD: 12.17 (309)
End Opening ID: 5.00 (127)
Width: 13.79 (350)

AH19334



Housing used with AF25963,
AF25962 Uses service part:
3946465S OptiAir 1100 Series.
11" plastic, w/safety, straight.

Overall Height: 18.87 (479)
Housing OD: 12.17 (309)
End Opening ID: 5.00 (127)
Width: 7.00 (350)

AH19351

ZHENGZHOU YUTONG
GROUP CO., LTD 110900483,
ZHENGZHOU YUTONG
GROUP CO., LTD
8108H016291 Housing used
with AF25276, AF25277

AH19474



Housing used with AF26116
Uses service part: 3946459S
OptiAir 400 Series Air Housing
Systems. 4" plastic, w/o safety,
straight.

Overall Height: 7.44 (189)
Largest housing OD: 5.42 (138)
End Connection OD: 2.00 (51)
Side Connection OD: 2.00 (51)

AH19476



Housing used with AF26117
Uses service part: 3946461S
OptiAir 600 Series Air Housing
Systems. 6" plastic, w/o
safety, straight.

Overall Height: 12.87 (327)
Largest housing OD: 7.57 (192)
End Connection OD: 3.00 (76)
Side Connection OD: 3.00 (76)

E. PRODUCT GUIDE

<p>AH19477</p>  <p>Housing used with AF26117, AF26118 Uses service part: 3946461S OptiAir 600 Series with Twist Lock, Straight Outlet, Safety Element.</p> <p>Overall Height: 12.87 (327) Largest housing OD: 7.56 (192) End Connection OD: 3.00 (76) Side Connection OD: 3.00 (76)</p>	<p>AH19484</p>  <p>Housing used with AF26116, AF26167 Uses service part: 3946459S OptiAir 400 Series with Twist Lock, 90 Degree Elbow, Primary and Safety.</p> <p>Overall Height: 7.44 (189) Largest housing OD: 5.42 (138) End Connection OD: 1.97 (50) Side Connection OD: 2.00 (51)</p>	<p>AH19491</p>  <p>Housing used with AF25960 Uses service part: 3946462S OptiAir 800 Series Air Housing Systems. 8" plastic, w/o safety, 90 elbow.</p> <p>Overall Height: 14.48 (368) Largest housing OD: 9.21 (234) End Connection OD: 3.50 (89) Side Connection OD: 3.75 (95)</p>
<p>AH19478</p>  <p>Housing used with AF26120 Uses service part: 3946463S OptiAir 1000 Series. 10" plastic, w/o safety, straight.</p>	<p>AH19485</p>  <p>Housing used with AF26116 Uses service part: 3946459S OptiAir 400 Series Air Housing Systems. 4" plastic, w/o safety, 90 elbow.</p> <p>Overall Height: 7.44 (189) Largest housing OD: 5.42 (138) End Connection OD: 2.00 (51) Side Connection OD: 2.00 (51)</p>	<p>AH19496</p>  <p>Housing used with AF26116, AF26167 Uses service part: 3946459S OptiAir 400 Series with Twist Lock, Straight Outlet, Primary and Safety.</p> <p>Overall Height: 7.44 (189) Largest housing OD: 5.42 (138) End Connection OD: 2.00 (51) Side Connection OD: 2.00 (51)</p>
<p>AH19479</p>  <p>Housing used with AF26120, AF26121 Uses service part: 3946463S OptiAir 1000 Series. 10" plastic, w/safety, straight.</p>	<p>AH19486</p>  <p>Housing used with AF26168, AF26166 Uses service part: 3946460S OptiAir 500 Series with Twist Lock, 90 Degree Elbow, Primary and Safety.</p> <p>Side Opening Offset: 1.87 (47) Overall Height: 7.98 (203) Dust collector: YES Largest housing OD: 6.41 (163) End Connection OD: 2.50 (64) Side Connection Loc: 1.50 (38) Side Connection Height: 1.54 (-39) Side Connection OD: 2.50 (64)</p>	<p>AH19497</p>  <p>ALASKA DIESEL 2426804</p> <p>Overall Height: 10.38 (264) Largest Housing OD: 12.50 (318) End Connection Height: 1.38 (35) End Connection ID: 5.50 (140)</p>
<p>AH19480</p>  <p>Housing used with AF26124 Uses service part: 3946467S OptiAir 1300 Series System with Twist Lock, Straight Outlet, Primary Only</p> <p>Overall Height: 23.03 (585) Dust collector: YES Largest housing OD: 14.02 (356) End Connection OD: 7.00 (178) Side Connection OD: 7.00 (178)</p>	<p>AH19487</p>  <p>Housing used with AF26168 Uses service part: 3946460S OptiAir 500 Series Air Housing Systems. 5" plastic, w/o safety, 90 elbow.</p> <p>Overall Height: 11.18 (284) Largest housing OD: 6.41 (163) End Connection OD: 2.50 (64) Side Connection OD: 2.50 (64)</p>	<p>Air Kits</p> <p>AK8</p>  <p>Bracket Assy For AF4516 (3839974 Wing nut included) (3311624 Bolt seal included)</p> <p>Gasket: 3316436</p>
<p>AH19481</p>  <p>Housing used with AF26124, AF26125 Uses service part: 3946467S OptiAir 1300 Series with Twist Lock, Straight Outlet, Primary and Safety.</p> <p>Overall Height: 23.03 (585) Dust collector: YES Largest housing OD: 14.02 (356) End Connection OD: 7.00 (178) Side Connection OD: 7.00 (178)</p>	<p>AH19488</p>  <p>Housing used with AF26117, AF26118 Uses service part: 3946461S OptiAir 600 Series Air Housing Systems. 6" plastic, w/safety, 90 elbow.</p> <p>Overall Height: 12.87 (327) Largest housing OD: 7.56 (192) End Connection OD: 3.00 (76) Side Connection OD: 3.00 (76)</p>	<p>AK12</p>  <p>Bracket Assy For AF4526 (3839975 Wing nut included) (3311624 Bolt seal included)</p> <p>Gasket: 3830152</p>
<p>AH19482</p>  <p>Housing used with AF26168, AF26166 Uses service part: 3946460S OptiAir 500 Series with Twist Lock, Straight Outlet, Primary and Safety.</p> <p>Side Opening Offset: 1.87 (47) Overall Height: 7.98 (203) Dust collector: YES Largest housing OD: 6.41 (163) End Connection OD: 2.50 (64) Side Connection Loc: 1.50 (38) Side Connection Height: 1.56 (-40) Side Connection OD: 2.50 (64)</p>	<p>AH19489</p>  <p>Housing used with AF26117 Uses service part: 3946461S OptiAir 600 Series Air Housing Systems. 6" plastic, w/o safety, 90 elbow.</p> <p>Overall Height: 12.87 (327) Largest housing OD: 7.56 (192) End Connection OD: 3.00 (76) Side Connection OD: 3.00 (76)</p>	<p>AK13</p>  <p>Bracket Assy For AF4771 (3839975 Wing nut included) (3311624 Bolt seal included)</p> <p>Gasket: 3834172</p>
<p>AH19483</p>  <p>Housing used with AF26168 Uses service part: 3946460S OptiAir 500 Series Air Housing Systems. 5" plastic, w/o safety, straight.</p> <p>Overall Height: 11.18 (284) Largest housing OD: 6.41 (163) End Connection OD: 2.50 (64) Side Connection OD: 2.50 (64)</p>	<p>AH19490</p>  <p>Housing used with AF25960, AF25961 Uses service part: 3946462S OptiAir 800 Series Air Housing Systems. 8" plastic, w/safety, 90 elbow.</p> <p>Overall Height: 14.49 (368) Largest housing OD: 9.21 (234) End Connection OD: 3.50 (89) Side Connection OD: 3.75 (95)</p>	<p>AK14</p>  <p>Uses service part: 3947659S 500 Series OptiAir A-Series Air Filter Kit without Safety and with Weatherhood</p>
		<p>AK15</p>  <p>Uses service part: 3947658S 600 Series OptiAir A-Series Air Filter Kit without Safety and with Weatherhood</p>
		<p>AK17</p>  <p>Uses service part: 394694S 500 Series OptiAir Air Cleaner Kit with Safety Element and Weatherhood.</p>
		<p>Air Precleaners</p> <p>AP2000</p>  <p>Uses service part: 3910200S, 3920138S, 3920175S Visibowl Air Precleaners with 2" Inlet OD and 30-90 CFM range.</p> <p>Intake Diameter: 2.00 (51) Height: 4.80 (122) Overall OD: 5.60 (142)</p>

E. PRODUCT GUIDE

AP3000



Uses service part: 3910300S
Visibowl Air Precleaners with
3" Inlet OD and 80-170 CFM
range.

Intake Diameter: 3.00 (76)
Height: 6.20 (157)
Overall OD: 7.40 (188)

AP4500



Uses service part: 3910450S
Visibowl Air Precleaners with
4.5" Inlet OD and 150-340
CFM range.

Intake Diameter: 4.50 (114)
Height: 7.70 (196)
Overall OD: 10.70 (272)

AP5000

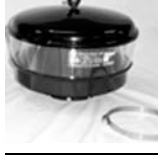

Uses service part: 3910500S,
3950600S Visibowl Air
Precleaners with 5" Inlet OD
and 330-740 CFM range.

Intake Diameter: 5.00 (127)
Height: 7.70 (196)
Overall OD: 12.10 (307)

AP8403



SY-KLONE 9001 Uses service
part: 3904837S, 3904838S,
3904839S Self-cleaning
Precleaners for 100-350
CFM4" Intake

Height: 6.29 (160)
End 1 OD: 8.51 (216)
End 2 ID: 4.03 (102)

AP8404



SY-KLONE 9002 Uses service
part: 3904840S, 3904841S,
3904842S Self-cleaning
Precleaners for 400-625
CFM6" Intake

Height: 11.10 (282)
End 1 OD: 13.06 (332)
End 2 ID: 6.04 (153)

AP8405



SY-KLONE 9003 Uses service
part: 3905073S, 3905074S
Self-cleaning Precleaner for
800-1300 CFM8" Intake

Height: 14.44 (367)
End 1 OD: 18.00 (457)
End 2 ID: 8.06 (205)

AP8406



SY-KLONE 9004 Uses service
part: 3905073S, 3905074S,
3918243S Self-cleaning
Precleaners for 1300-1800
CFM8" Intake

Height: 14.44 (367)
End 1 OD: 18.00 (457)
End 2 ID: 8.06 (205)

AP8407



Self-Cleaning Precleaners for
10-50 CFM2" Intake

Height: 2.50 (64)
End 2 OD: 4.50 (114)
End 2 ID: 2.02 (51)

AP8408



Uses service part: 3918240S
Self-Cleaning Precleaners for
50-120 CFM3" Intake

Height: 4.20 (107)
End 2 OD: 6.70 (170)
End 2 ID: 3.02 (77)

AP8409



Uses service part: 3904837S,
3904838S, 3904839S Self-
cleaning Precleaners for 350-
425 CFM4" Intake

Height: 6.29 (160)
End 2 OD: 8.50 (216)
End 2 ID: 4.03 (102)

AP8410



Uses service part: 3904840S,
3904841S, 3904842S Self-
cleaning Precleaners for 650-
825 CFM6" Intake

Height: 11.10 (282)
End 2 OD: 13.06 (332)
End 2 ID: 6.04 (153)

AP85041

SY-KLONE 9502LF001 Dual
Stage Precleaner Consists of:
AP8404, 3939411S,
3939412S, 3953520S,
3946090S, 3953535S,
3952334S, 3952353S

Intake Diameter: 2.00 (50.8)
Height: 36.816 (935.13)
Width: 10.500 (266.7)
Length: 11.52 (292.61)
Lower ID: 6.00 (152.4)

AP85042

SY-KLONE 9502LF002 Dual
Stage Precleaner Consists of:
AP8404, 3939411S,
3939412S, 3953521S,
3946090S, 3953530S,
3952334S, 3952353S

Intake Diameter: 2.00 (50.8)
Height: 34.684 (880.97)
Width: 10.75 (273.05)
Length: 11.853 (301.07)
Lower ID: 5.875 (149.22)

AP85043



SY-KLONE 9502003 Dual
Stage Precleaner Consists of:
AP8404, 3939412S, 3953525S

Intake Diameter: 2.00 (50.8)
Height: 21.474 (545.44)
Width: 10.00 (254.00)
Length: 10.00 (254.00)
Lower ID: 6.00 (152.4)

AP85044



SY-KLONE 9502004 Dual
Stage Precleaner Consists of:
AP8404, 3939412S, 3953526S

Intake Diameter: 2.00 (50.8)
Height: 20.927 (531.55)
Width: 10.00 (254.00)
Length: 10.00 (254.00)
Lower ID: 6.00 (152.4)

AP85046

SY-KLONE 9502RLF006 Dual
Stage Precleaner Consists of:
AP8404, 3939412S,
3953526S, 3939411S,
3946090S

Intake Diameter: 2.00 (50.8)
Height: 32.068 (814.53)
Width: 10.00 (254.00)
Length: 10.00 (254.00)
Lower ID: 6.00 (152.4)

AP85047

SY-KLONE 9502RLF007 Dual
Stage Precleaner Consists of:
AP8404, 3939412S,
3953525S, 3939411S,
3946090S

Intake Diameter: 2.00 (50.8)
Height: 32.949 (836.9)
Width: 10.00 (254.00)
Length: 10.00 (254.00)
Lower ID: 6.00 (152.4)

AP85051

SY-KLONE 9503LF001 Dual
Stage Precleaner Consists of:
AP8405, 3946105S,
3952350S, 3953523S,
3946089S, 3953535S,
3952334S, 3952353S

Intake Diameter: 2.00 (50.8)
Height: 39.704 (1008.48)
Width: 12.8 (325.12)
Length: 13.121 (333.27)
Lower ID: 7.00 (177.8)

AP85052

SY-KLONE 9503002 Dual
Stage Precleaner Consists of:
AP8405, 3952350S, 3953527S

Intake Diameter: 2.00 (50.8)
Height: 27.847 (707.31)
Width: 12.00 (304.8)
Length: 12.625 (320.67)
Lower ID: 7.00 (177.8)

AP85053

SY-KLONE 9503LF003 Dual
Stage Precleaner Consists of:
AP8405, 3946105S,
3952350S, 3953524S,
3946089S, 3953535S,
3952353S

Intake Diameter: 2.005 (50.93)
Height: 41.872 (1063.55)
Width: 11.89 (302.01)
Length: 13.039 (331.19)
Lower ID: 7.00 (177.8)

AP85054

SY-KLONE 9503004 Dual
Stage Precleaner Consists of:
AP8405, 3952350S, 3953528S







Intake Diameter: 2.00 (50.8)
Height: 26.367 (677.6)
Width: 12.00 (304.8)
Length: 12.625 (320.67)
Lower ID: 7.00 (177.8)

AP85055

















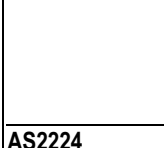









SY-KLONE 9503LF005 Dual
Stage Precleaner Consists of:
AP8405, 3946105S,
3952350S, 3953527S,
3946089S, 3952361S,
3952362S, 3952351S,
3952363S, 3953533S

Intake Diameter: 2.00 (50.8)
Height: 44.919 (1140.94)
Width: 12.00 (304.8)
Length: 12.625 (320.67)
Lower ID: 7.00 (177.8)

























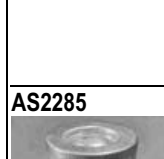

E. PRODUCT GUIDE

<p>AP85057 SY-KLONE 9503LF007 Dual Stage Precleaner Consists of: AP8405, 3946105S, 3952350S, 3953528S, 3946089S</p> <p>Intake Diameter: 2.00 (50.8) Height: 37.466 (951.64) Width: 12.00 (304.8) Length: 12.625 (320.67) Lower ID: 7.00 (177.8)</p>	<p>AP85101 SY-KLONE 9502R01 Dual Stage Precleaner Consists of: AP8410, 3939412S, 3953525S</p> <p>Intake Diameter: 2.00 (50.8) Height: 22.31 (566.67) Width: 10.00 (254.00) Length: 10.00 (254.00) Lower ID: 6.00 (152.4)</p>	<p>AP85163 SY-KLONE 9504LF003 Dual Stage Precleaner Consists of: AF8406, 3946105S, 3952350S, 3953528S, 3946089S</p> <p>Intake Diameter: 2.00 (50.8) Height: 37.372 (949.25) Width: 12.00 (304.8) Length: 12.625 (320.67) Lower ID: 7.00 (177.8)</p>
<p>AP85058 SY-KLONE 9503LF008 Dual Stage Precleaner Consists of: AP8405, 3946105S, 3952350S, 3953527S, 3946089S</p> <p>Intake Diameter: 2.00 (50.8) Height: 38.567 (979.6) Width: 12.00 (304.8) Length: 12.625 (320.67) Lower ID: 7.00 (177.8)</p>	<p>AP85102 SY-KLONE 9502R002 Dual Stage Precleaner Consists of: AP8410, 3939412S, 3953526S</p> <p>Intake Diameter: 2.00 (50.8) Height: 21.157 (537.39) Width: 10.00 (254.00) Length: 10.00 (254.00) Lower ID: 6.00 (152.4)</p>	<p>AP85104 SY-KLONE 9502RLF004 Dual Stage Precleaner Consists of: AF4810, 3939412S, 3953525S, 3939411S, 3946090S</p> <p>Intake Diameter: 2.00 (50.8) Height: 32.949 (836.9) Width: 10.00 (254.00) Length: 10.00 (254.00) Lower ID: 6.00 (152.4)</p>
<p>AP85061 SY-KLONE 9504LF001 Dual Stage Precleaner Consists of: AP8406, 3953535S, 3952353S, 3953518S, 3953544S, 3952351S, 3953529S</p> <p>Intake Diameter: 2.00 (50.8) Height: 45.733 (1161.62) Lower ID: 7.5 (190.5)</p>	<p>AP85105 SY-KLONE 9502RLF005 Dual Stage Precleaner Consists of: AP8410, 3939412S, 3953526S, 3939411S, 3946090S</p> <p>Intake Diameter: 2.00 (50.8) Height: 32.068 (814.53) Width: 10.00 (254.00) Length: 10.00 (254.00) Lower ID: 6.00 (152.4)</p>	<p>AP85152 SY-KLONE 9503LF002 Dual Stage Precleaner Consists of: AF8405, 3946107S, 3946109S, 3953522S, 3946089S, 3953529S, 3952334S, 3953535S, 3952353S</p> <p>Intake Diameter: 2.005 (50.93) Height: 43.392 (1102.16) Width: 10.75 (273.05) Length: 11.869 (301.47) Lower ID: 6.00 (152.4)</p>
<p>AP85062 SY-KLONE 9504LF002 Dual Stage Precleaner Consists of: AP8406, 3946105S, 3952350S, 3953527S, 3946089S</p> <p>Intake Diameter: 2.00 (50.8) Height: 38.387 (975.03) Width: 12.00 (304.8) Length: 12.625 (320.67) Lower ID: 7.00 (177.8)</p>	<p>AP85154 SY-KLONE 9503LF004, SY-KLONE 836HOPTIKIT Dual Stage Precleaner Consists of: AP8405, 3946105S, 3952350S, 3953519S, 3940689S, 3952360S, 3952361S, 3953535S, 3953530S</p> <p>Intake Diameter: 2.00 (50.8) Height: 38.063 (966.8) OD: 13.75 (349.25)</p>	<p>AP85063 SY-KLONE 9504003 Dual Stage Precleaner Consists of: AP8406, 3952350S, 3953527S</p> <p>Intake Diameter: 2.00 (50.8) Height: 27.541 (699.54) Width: 12.00 (304.8) Length: 12.625 (320.67) Lower ID: 7.00 (177.8)</p>
<p>AP85064 SY-KLONE 9504004 Dual Stage Precleaner Consists of: AP8406, 3952350S, 3953528S</p> <p>Intake Diameter: 2.00 (50.8) Height: 26.593 (675.46) Width: 12.00 (304.8) Length: 12.625 (320.67) Lower ID: 7.00 (177.8)</p>	<p>Air/Oil Separators</p> <p>AS2200 ATLAS COPCO 16132433</p>  <p>Overall Height: 12.50 (318) Flange Diameter: 11.81 (300) End 2 OD: 6.75 (171) End 1 ID: 4.81 (122) Thread Size: M8 X 1.25-6H INT</p> <hr/> <p>AS2201 ATLAS COPCO 16162836</p>  <p>Overall Height: 18.88 (480) Flange Diameter: 11.81 (300) End 2 OD: 6.75 (171) End 1 ID: 4.81 (122) Thread Size: M8 X 1.25-6H INT</p> <hr/> <p>AS2202 ATLAS COPCO 22526313</p>  <p>Overall Height: 32.21 (818) Flange Diameter: 15.75 (400) End 2 OD: 10.88 (276) End 1 ID: 8.38 (213)</p> <hr/> <p>AS2203 ATLAS COPCO 16195498</p>  <p>Overall Height: 9.00 (229) Flange Diameter: 8.62 (219) End 2 OD: 6.62 (168) End 1 ID: 4.12 (105) Thread Size: M8 X 1.25-6H INT</p> <hr/> <p>AS2205 DAVEY 48773</p>  <p>Overall Height: 10.69 (272) Flange Diameter: 12.00 (305) End 2 OD: 8.38 (213) End 1 ID: 5.88 (149)</p> <hr/> <p>AS2206 DAVEY 48775</p>  <p>Overall Height: 15.31 (389) Flange Diameter: 14.25 (362) End 2 OD: 10.38 (264) End 1 ID: 7.88 (200)</p> <hr/> <p>AS2207 DAVEY 48776</p>  <p>Overall Height: 25.19 (640) Flange Diameter: 18.62 (473) End 2 OD: 14.88 (378) End 1 ID: 12.38 (314)</p>	



























E. PRODUCT GUIDE

AS2208 DAVEY 49593  Overall Height: 18.25 (464) Flange Diameter: 13.75 (349) End 2 OD: 10.88 (276) End 1 ID: 8.38 (213)	AS2221 GARDNER-DENVER 2109430  Overall Height: 12.19 (310) Flange Diameter: 12.00 (305) End 2 OD: 8.38 (213) End 1 ID: 5.88 (149)	AS2236 GARDNER-DENVER 55B29  Overall Height: 22.25 (565) Flange Diameter: 23.75 (603) End 2 OD: 19.00 (483) End 1 ID: 15.00 (381)
AS2211 GARDNER-DENVER 55B7  Overall Height: 8.25 (210) Flange Diameter: 10.38 (264) End 2 OD: 8.38 (213) End 1 ID: 5.88 (149)	AS2222 GARDNER-DENVER 1157866  Overall Height: 9.50 (241) Flange Diameter: 10.00 (254) End 2 OD: 8.38 (213) End 1 ID: 5.88 (149)	AS2238 GARDNER-DENVER 55B38  Overall Height: 32.38 (822) Flange Diameter: 25.50 (648) End 2 OD: 21.00 (533) End 1 ID: 17.00 (432)
AS2212 GARDNER-DENVER 55B13  Overall Height: 23.47 (596) Flange Diameter: 12.00 (305) End 2 OD: 8.38 (213) End 1 ID: 5.88 (149)	AS2223 GARDNER-DENVER 55B22  Overall Height: 23.25 (591) Flange Diameter: 12.00 (305) End 2 OD: 8.38 (213) End 1 ID: 5.25 (133)	AS2242 GARDNER-DENVER 55B32  Overall Height: 18.12 (460) Flange Diameter: 12.00 (305) End 2 OD: 8.38 (213) End 1 ID: 5.25 (133)
AS2213 GARDNER-DENVER 55B4  Overall Height: 23.47 (596) Flange Diameter: 12.00 (305) End 2 OD: 8.38 (213) End 1 ID: 5.88 (149)	AS2224 GARDNER-DENVER 55B23  Overall Height: 12.00 (305) Flange Diameter: 12.00 (305) End 2 OD: 8.38 (213) End 1 ID: 5.25 (133)	AS2244 GARDNER-DENVER 55B33  Overall Height: 9.12 (232) Flange Diameter: 12.00 (305) End 2 OD: 8.38 (213) End 1 ID: 5.25 (133)
AS2214 GARDNER-DENVER 55B8  Overall Height: 14.56 (370) Flange Diameter: 5.50 (140) End 2 OD: 4.00 (102) End 1 ID: 2.00 (51)	AS2225 GARDNER-DENVER ECM81157  Overall Height: 12.25 (311) Flange Diameter: 12.00 (305) End 2 OD: 8.38 (213) End 1 ID: 5.25 (133)	AS2246 GARDNER-DENVER 55B34  Overall Height: 9.25 (235) Flange Diameter: 11.50 (292) End 2 OD: 8.38 (213) End 1 ID: 5.25 (133)
AS2215 GARDNER-DENVER 55B9  Overall Height: 19.14 (486) Flange Diameter: 5.50 (140) End 2 OD: 4.00 (102) End 1 ID: 2.00 (51)	AS2226 GARDNER-DENVER 55B24  Overall Height: 9.25 (235) Flange Diameter: 17.50 (445) End 2 OD: 8.38 (213) End 1 ID: 5.25 (133)	AS2249 GARDNER-DENVER 55B35  Overall Height: 16.75 (425) Flange Diameter: 12.00 (305) End 2 OD: 8.38 (213) End 1 ID: 5.25 (133)
AS2217 GARDNER-DENVER 2014828  Overall Height: 16.94 (430) Flange Diameter: 12.00 (305) End 2 OD: 8.38 (213) End 1 ID: 5.88 (149)	AS2229 GARDNER-DENVER ECM80135  Overall Height: 18.25 (464) Flange Diameter: 21.00 (533) End 2 OD: 8.38 (213) End 1 ID: 5.25 (133)	AS2251 GARDNER-DENVER 55B36  Overall Height: 14.18 (360) Flange Diameter: 11.50 (292) End 2 OD: 8.38 (213) End 1 ID: 5.25 (133)
AS2218 GARDNER-DENVER 2014830  Overall Height: 23.50 (597) Flange Diameter: 14.38 (365) End 2 OD: 10.88 (276) End 1 ID: 8.38 (213)	AS2232 GARDNER-DENVER 55B27  Overall Height: 22.19 (564) Flange Diameter: 14.38 (365) End 2 OD: 10.88 (276) End 1 ID: 7.44 (189)	AS2253 GARDNER-DENVER 55B37  Overall Height: 22.25 (565) Flange Diameter: 17.00 (432) End 2 OD: 10.88 (276) End 1 ID: 7.44 (189)
AS2220 GARDNER-DENVER 2109429  Overall Height: 11.12 (282) Flange Diameter: 5.50 (140) End 2 OD: 4.00 (102) End 1 ID: 2.00 (51)	AS2234 GARDNER-DENVER 55B28  Overall Height: 24.19 (614) Flange Diameter: 17.50 (445) End 2 OD: 14.88 (378) End 1 ID: 11.40 (290)	AS2254 GARDNER-DENVER 200EAP035  Overall Height: 24.00 (610) Flange Diameter: 21.00 (533) End 2 OD: 9.62 (244) End 1 ID: 5.25 (133)



























E. PRODUCT GUIDE

AS2256 INGERSOLL-RAND 35577220  <p>Overall Height: 18.81 (478) Flange Diameter: 9.84 (250) End 2 OD: 8.00 (203) End 1 ID: 5.38 (137)</p>	AS2265 INGERSOLL-RAND 36506038  <p>Overall Height: 9.00 (229) Flange Diameter: 6.69 (170) End 2 OD: 4.88 (124) End 1 ID: 3.12 (79)</p>	AS2276 INGERSOLL-RAND 39738265  <p>Overall Height: 14.00 (356) Flange Diameter: 13.25 (337) End 2 OD: 8.38 (213) End 1 ID: 5.25 (133)</p>
AS2257 INGERSOLL-RAND 35577238  <p>Overall Height: 21.41 (544) Flange Diameter: 11.94 (303) End 2 OD: 8.38 (213) End 1 ID: 5.88 (149)</p>	AS2266 AIR MAZE GS24024  <p>Overall Height: 11.69 (297) Flange Diameter: 7.12 (181) End 2 OD: 6.12 (155) End 1 ID: 3.65 (93)</p>	AS2277 INGERSOLL-RAND 39742861  <p>Overall Height: 17.38 (441) Flange Diameter: 16.88 (429) End 2 OD: 14.88 (378) End 1 ID: 11.40 (290)</p>
AS2258 INGERSOLL-RAND 35580661  <p>Overall Height: 36.81 (935) Flange Diameter: 16.44 (418) End 2 OD: 10.88 (276) End 1 ID: 8.38 (213)</p>	AS2267 INGERSOLL-RAND 36723666  <p>Overall Height: 13.00 (330) Flange Diameter: 11.76 (299) End 2 OD: 10.38 (264) End 1 ID: 7.88 (200)</p>	AS2278 INGERSOLL-RAND 39727490  <p>Overall Height: 24.75 (629) Flange Diameter: 18.75 (476) End 2 OD: 14.88 (378) End 1 ID: 11.40 (290)</p>
AS2259 AIR MAZE GS24010  <p>Overall Height: 15.14 (385) Flange Diameter: 12.25 (311) End 2 OD: 9.62 (244) End 1 ID: 7.12 (181)</p>	AS2268 INGERSOLL-RAND 35579184  <p>Overall Height: 15.75 (400) Flange Diameter: 8.12 (206) End 2 OD: 6.12 (155) End 1 ID: 3.62 (92)</p>	AS2279 INGERSOLL-RAND 39750369  <p>Overall Height: 18.25 (464) Flange Diameter: 21.00 (533) End 2 OD: 19.00 (483) End 1 ID: 15.00 (381)</p>
AS2260 INGERSOLL-RAND 39504147  <p>Overall Height: 23.41 (595) Flange Diameter: 18.25 (464) End 2 OD: 14.88 (378) End 1 ID: 12.38 (314)</p>	AS2269 INGERSOLL-RAND 35577212  <p>Overall Height: 32.50 (826) Flange Diameter: 18.50 (470) End 2 OD: 13.31 (338) End 1 ID: 10.81 (275)</p>	AS2282 INGERSOLL-RAND 39748439  <p>Overall Height: 30.25 (768) Flange Diameter: 19.12 (486) End 2 OD: 11.88 (302)</p>
AS2261 INGERSOLL-RAND 39712070  <p>Overall Height: 32.00 (813) Flange Diameter: 18.75 (476) End 2 OD: 14.88 (378) End 1 ID: 12.38 (314)</p>	AS2270 INGERSOLL-RAND 39722897  <p>Overall Height: 20.38 (518) Flange Diameter: 14.25 (362) End 2 OD: 10.38 (264) End 1 ID: 7.88 (200)</p>	AS2285 INGERSOLL-RAND 39742598  <p>Overall Height: 14.00 (356) Flange Diameter: 9.00 (229) End 2 OD: 5.75 (146) End 1 ID: 2.88 (73)</p>
AS2262 INGERSOLL-RAND 39726286  <p>Overall Height: 10.56 (268) Flange Diameter: 7.65 (194) End 2 OD: 6.75 (171) End 1 ID: 4.12 (105)</p>	AS2271 INGERSOLL-RAND 39755863  <p>Overall Height: 9.00 (229) Flange Diameter: 8.00 (203) End 2 OD: 4.88 (124) End 1 ID: 2.50 (64)</p>	AS2288 JOY 5431170013  <p>Overall Height: 30.25 (768) Flange Diameter: 18.00 (457) End 2 OD: 14.88 (378) End 1 ID: 12.31 (313)</p>
AS2263 INGERSOLL-RAND 39739578  <p>Overall Height: 18.00 (457) Flange Diameter: 15.25 (387) End 2 OD: 11.88 (302) End 1 ID: 8.44 (214)</p>	AS2272 INGERSOLL-RAND 39749429  <p>Overall Height: 13.25 (337) Flange Diameter: 9.00 (229) End 2 OD: 5.75 (146) End 1 ID: 3.62 (92)</p>	AS2292 JOY 5431170018  <p>Overall Height: 42.19 (1072) Flange Diameter: 16.44 (418) End 2 OD: 14.88 (378) End 1 ID: 12.38 (314)</p>
AS2264 INGERSOLL-RAND 35813187  <p>Overall Height: 10.88 (276) Flange Diameter: 6.44 (164) End 2 OD: 4.88 (124) End 1 ID: 3.12 (79)</p>	AS2274 INGERSOLL-RAND 39734892  <p>Overall Height: 10.50 (267) Flange Diameter: 9.38 (238) End 2 OD: 6.88 (175) End 1 ID: 3.81 (97)</p>	AS2293 JOY 5431170019  <p>Overall Height: 24.12 (613) Flange Diameter: 12.50 (318) End 2 OD: 8.38 (213) End 1 ID: 5.88 (149)</p>

E. PRODUCT GUIDE

AS2294 JOY 00543117-0012  Overall Height: 4.25 (108) Flange Diameter: 12.00 (305) End 2 OD: 8.00 (203) End 1 ID: 5.88 (149)	AS2307 JOY 5431170041  Overall Height: 10.12 (257) Flange Diameter: 12.00 (305) End 2 OD: 8.38 (213) End 1 ID: 5.88 (149)	AS2323 QUINCY 20066  Overall Height: 12.88 (327) Flange Diameter: 14.00 (356) End 2 OD: 10.88 (276) End 1 ID: 8.38 (213)
AS2295 JOY 5431170020  Overall Height: 24.19 (614) Flange Diameter: 13.75 (349) End 2 OD: 10.88 (276) End 1 ID: 8.38 (213)	AS2309 JOY 5431170044  Overall Height: 12.50 (318) Flange Diameter: 13.44 (341) End 2 OD: 10.88 (276) End 1 ID: 7.88 (200)	AS2324 QUINCY 20067  Overall Height: 17.00 (432) Flange Diameter: 14.00 (356) End 2 OD: 10.88 (276)
AS2297 JOY 5431170026  Overall Height: 10.19 (259) Flange Diameter: 10.25 (260) End 2 OD: 8.38 (213) End 1 ID: 5.88 (149)	AS2311 LEROI 435582  Overall Height: 9.12 (232) Flange Diameter: 15.38 (391) End 2 OD: 11.88 (302) End 1 ID: 9.38 (238)	AS2326 QUINCY 227051  Overall Height: 18.25 (464) Flange Diameter: 10.38 (264) End 2 OD: 8.38 (213) End 1 ID: 5.88 (149)
AS2298 JOY 5431170029  Overall Height: 16.38 (416) Flange Diameter: 10.25 (260) End 2 OD: 8.38 (213) End 1 ID: 5.88 (149)	AS2312 LEROI 435583  Overall Height: 24.50 (622) Flange Diameter: 15.38 (391) End 2 OD: 11.88 (302) End 1 ID: 9.38 (238)	AS2327 QUINCY 227052  Overall Height: 18.12 (460) Flange Diameter: 12.75 (324) End 2 OD: 10.88 (276) End 1 ID: 8.38 (213)
AS2300 JOY 5431170024  Overall Height: 5.25 (133) Flange Diameter: 16.00 (406) End 2 OD: 10.38 (264) End 1 ID: 8.38 (213)	AS2313 LEROI 435584  Overall Height: 12.09 (307) Flange Diameter: 15.38 (391) End 2 OD: 11.88 (302) End 1 ID: 9.38 (238)	AS2329 QUINCY 227054  Overall Height: 28.00 (711) Flange Diameter: 17.12 (435) End 2 OD: 14.88 (378) End 1 ID: 12.38 (314)
AS2302 JOY 5431170030  Overall Height: 23.50 (597) Overall OD: 13.75 (349) End 1 ID: 10.75 (273)	AS2319 LEROI 437451  Overall Height: 15.75 (400) Flange Diameter: 15.38 (391) End 2 OD: 6.88 (175) End 1 ID: 5.00 (127)	AS2331 QUINCY 227058  Overall Height: 9.38 (238) Flange Diameter: 10.38 (264) End 2 OD: 8.38 (213) End 1 ID: 5.88 (149)
AS2303 JOY 5431170031  Overall Height: 20.69 (526) Flange Diameter: 10.69 (272) End 2 OD: 8.00 (203) End 1 ID: 5.88 (149)	AS2320 LEROI 43747  Overall Height: 9.44 (240) Flange Diameter: 15.50 (394) End 2 OD: 10.88 (276) End 1 ID: 8.38 (213)	AS2333 QUINCY 1221171  Overall Height: 10.16 (258) Flange Diameter: 10.38 (264) End 2 OD: 4.88 (124) End 1 ID: 3.12 (79)
AS2304 JOY 5431170032  Overall Height: 18.56 (471) Flange Diameter: 18.00 (457) End 2 OD: 14.88 (378) End 1 ID: 12.38 (314)	AS2321 LEROI 43758  Overall Height: 10.62 (270) Flange Diameter: 8.62 (219) End 2 OD: 6.75 (171) End 1 ID: 5.00 (127)	AS2334 QUINCY 1221172  Overall Height: 12.16 (309) Flange Diameter: 12.75 (324) End 2 OD: 6.12 (155) End 1 ID: 3.62 (92)
AS2306 JOY 5431170040  Overall Height: 6.12 (155) Flange Diameter: 12.00 (305) End 2 OD: 8.38 (213) End 1 ID: 5.88 (149)	AS2322 QUINCY 20065  Overall Height: 12.00 (305) Flange Diameter: 11.00 (279) End 2 OD: 8.38 (213) End 1 ID: 5.88 (149)	AS2337 QUINCY 1221175  Overall Height: 18.16 (461) Flange Diameter: 17.12 (435) End 2 OD: 10.88 (276) End 1 ID: 8.38 (213)

E. PRODUCT GUIDE

AS2338  QUINCY 1221177 Overall Height: 28.19 (716) Flange Diameter: 23.25 (591) End 2 OD: 10.88 (276) End 1 ID: 8.38 (213)	AS2351  SULLAIR 1075 Overall Height: 24.19 (614) Flange Diameter: 10.66 (271) End 2 OD: 8.38 (213) End 1 ID: 5.88 (149)	AS2363  SULLAIR 410333 Overall Height: 8.00 (203) Flange Diameter: 7.88 (200) End 2 OD: 6.88 (175) End 1 ID: 3.88 (99)
AS2339  QUINCY 1221178 Overall Height: 6.15 (156) Flange Diameter: 10.38 (264) End 2 OD: 4.88 (124) End 1 ID: 3.12 (79)	AS2352  SULLAIR 11088 Overall Height: 26.00 (660) Flange Diameter: 13.75 (349) End 2 OD: 11.88 (302) End 1 ID: 9.62 (244)	AS2365  SULLAIR 47043 Overall Height: 6.81 (173) Flange Diameter: 7.88 (200) End 2 OD: 6.88 (175) End 1 ID: 3.88 (99)
AS2340  QUINCY 124487003 Overall Height: 9.50 (241) Flange Diameter: 12.75 (324) End 2 OD: 10.62 (270) End 1 ID: 7.44 (189)	AS2353  SULLAIR 408167002 Overall Height: 23.25 (591) Flange Diameter: 13.75 (349) End 2 OD: 8.38 (213) End 1 ID: 7.00 (178)	AS2367  SULLAIR 1148 Overall Height: 25.06 (637) Flange Diameter: 22.00 (559) End 2 OD: 19.00 (483) End 1 ID: 15.00 (381)
AS2341  QUINCY 124487004 Overall Height: 18.25 (464) Flange Diameter: 17.00 (432) End 2 OD: 14.88 (378) End 1 ID: 11.40 (290)	AS2354  SULLAIR 408167003 Overall Height: 36.25 (921) Flange Diameter: 23.25 (591) End 2 OD: 19.00 (483) End 1 ID: 15.00 (381)	AS2368  SULLAIR 250005547 Overall Height: 10.75 (273) Flange Diameter: 10.62 (270) End 2 OD: 8.38 (213) End 1 ID: 5.25 (133)
AS2344  SULLAIR 241503 Overall Height: 11.75 (298) Flange Diameter: 7.88 (200) End 2 OD: 6.88 (175) End 1 ID: 4.12 (105)	AS2355  SULLAIR 408167004 Overall Height: 26.62 (676) Flange Diameter: 23.25 (591) End 2 OD: 10.88 (276) End 1 ID: 7.44 (189)	AS2372  SULLAIR 250007139 Overall Height: 20.50 (521) Flange Diameter: 13.75 (349) End 2 OD: 10.62 (270) End 1 ID: 7.12 (181)
AS2346  SULLAIR 250002066 Overall Height: 26.25 (667) Overall OD: 10.88 (276)	AS2356  SULLAIR 408167005 Overall Height: 16.00 (406) Flange Diameter: 10.66 (271) End 2 OD: 8.38 (213) End 1 ID: 5.25 (133)	AS2379  WORTHINGTON FLR383 Overall Height: 24.25 (616) Flange Diameter: 23.00 (584) End 2 OD: 19.00 (483) End 1 ID: 16.25 (413)
AS2348  SULLAIR 11101 Overall Height: 9.69 (246) Flange Diameter: 7.88 (200) End 2 OD: 6.88 (175) End 1 ID: 4.12 (105)	AS2357  SULLAIR 408167006 Overall Height: 24.00 (610) Flange Diameter: 10.66 (271) End 2 OD: 8.38 (213) End 1 ID: 5.25 (133)	AS2380  WORTHINGTON FLR395 Overall Height: 12.16 (309) Flange Diameter: 12.50 (318) End 2 OD: 8.38 (213) End 1 ID: 5.88 (149)
AS2349  SULLAIR 40260 Overall Height: 32.44 (824) Flange Diameter: 26.50 (673) End 2 OD: 21.00 (533) End 1 ID: 18.25 (464)	AS2358  SULLAIR 408167007 Overall Height: 22.25 (565) Flange Diameter: 23.75 (603) End 2 OD: 19.00 (483) End 1 ID: 15.00 (381)	AS2381  WORTHINGTON PUMP FLR397 Overall Height: 18.12 (460) Flange Diameter: 12.50 (318) End 2 OD: 8.38 (213) End 1 ID: 5.88 (149)
AS2350  SULLAIR 11001 Overall Height: 17.00 (432) Flange Diameter: 7.88 (200) End 2 OD: 6.88 (175) End 1 ID: 4.12 (105)	AS2360  SULLAIR 409267 Overall Height: 24.25 (616) Flange Diameter: 13.75 (349) End 2 OD: 10.88 (276)	AS2382  WORTHINGTON PUMP FLR400 Overall Height: 21.19 (538) Flange Diameter: 16.50 (419) End 2 OD: 10.38 (264) End 1 ID: 7.88 (200)

E. PRODUCT GUIDE

AS2383 WORTHINGTON FLR436



Overall Height: 12.16 (309)
 Flange Diameter: 12.00 (305)
 End 2 OD: 8.38 (213)
 End 1 ID: 5.88 (149)

AS2384 CHICAGO-PNEUMATIC 1PS4801



Overall Height: 26.00 (660)
 Overall OD: 11.50 (292)
 End 1 ID: 9.25 (235)

AS2387 KELTEC KH730006



Overall Height: 38.50 (978)
 Flange Diameter: 16.44 (418)
 End 2 OD: 13.81 (351)
 End 1 ID: 8.38 (213)

AS2388 SULLAIR 408167011



Overall Height: 14.00 (356)
 Flange Diameter: 10.75 (273)
 End 2 OD: 4.00 (102)
 End 1 ID: 2.00 (51)

AS2389 BAUER DV375, KAESER 619620



Overall Height: 24.09 (612)
 End 1 OD: 10.75 (273)
 End 2 OD: 8.62 (219)
 End 1 ID: 6.50 (165)

AS2390 ATLAS COPCO 12026414

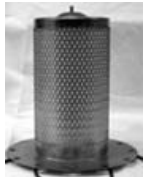

Overall Height: 13.07 (332)
 End 1 OD: 11.81 (300)
 End 2 OD: 6.61 (168)
 End 1 ID: 4.80 (122)
 Thread Size: M8 X 1.25-6H INT

AS2391 ATLAS COPCO 12028722



Overall Height: 6.81 (173)
 End 1 OD: 8.66 (220)
 End 2 OD: 5.28 (134)
 End 1 ID: 2.95 (75)

AS2392 ATLAS COPCO 16123869



Overall Height: 10.91 (277)
 End 1 OD: 8.66 (220)
 End 2 OD: 5.28 (134)
 End 1 ID: 3.47 (88)
 Thread Size: M8 X 1.25-6H INT

AS2393 ATLAS COPCO 16144373



Overall Height: 10.12 (257)
 End 1 OD: 11.81 (300)
 End 2 OD: 8.62 (219)
 End 1 ID: 6.50 (165)
 Thread Size: M8 X 1.25-6H INT

AS2394 ATLAS COPCO 16196248



Overall Height: 7.36 (187)
 End 1 OD: 8.66 (220)
 End 2 OD: 6.61 (168)
 End 1 ID: 4.80 (122)
 Thread Size: M8 X 1.25-6H INT

AS2395 BAUER KB22531430



Overall Height: 12.48 (317)
 End 1 OD: 7.87 (200)
 End 2 OD: 6.61 (168)
 End 1 ID: 4.80 (122)

AS2396 BAUER KB22959430



Overall Height: 8.15 (207)
 End 1 OD: 9.76 (248)
 End 2 OD: 6.61 (168)
 End 1 ID: 4.80 (122)
 Thread Size: M8 X 1.25-6H INT

AS2397 BOGE 575000206



Overall Height: 8.35 (212)
 End 1 OD: 6.69 (170)
 End 2 OD: 5.28 (134)
 End 1 ID: 3.47 (88)

AS2398 COMPAIR 98262102



Overall Height: 6.77 (172)
 End 1 OD: 7.87 (200)
 End 2 OD: 6.61 (168)
 End 1 ID: 4.80 (122)

AS2399 COMPAIR 98262108



Overall Height: 9.53 (242)
 End 1 OD: 9.84 (250)
 End 2 OD: 6.61 (168)
 End 1 ID: 4.80 (122)

AS2400 COMPAIR 98262120



Overall Height: 5.51 (140)
 End 1 OD: 6.50 (165)
 End 2 OD: 4.92 (125)
 End 1 ID: 2.99 (76)

AS2401 COMPAIR 98262121



Overall Height: 9.53 (242)
 End 1 OD: 7.87 (200)
 End 2 OD: 6.61 (168)
 End 1 ID: 4.80 (122)

AS2402 COMPAIR 9826233



Overall Height: 9.53 (242)
 End 1 OD: 9.37 (238)
 End 2 OD: 6.61 (168)
 End 1 ID: 4.80 (122)

AS2403 COMPAIR 982625073



Overall Height: 12.48 (317)
 End 1 OD: 8.58 (218)
 End 2 OD: 6.61 (168)
 End 1 ID: 4.80 (122)
 Thread Size: M8 X 1.25-6H INT

AS2404 COMPAIR 982625079



Overall Height: 12.48 (317)
 End 1 OD: 14.69 (373)
 End 2 OD: 10.79 (274)
 End 1 ID: 8.50 (216)

AS2405 COMPAIR 982625085



Overall Height: 7.44 (189)
 End 1 OD: 8.58 (218)
 End 2 OD: 6.61 (168)
 End 1 ID: 4.80 (122)
 Thread Size: M8 X 1.25-6H INT

AS2406 COMPAIR 9826277



Overall Height: 12.99 (330)
 End 1 OD: 10.75 (273)
 End 2 OD: 8.62 (219)
 End 1 ID: 6.50 (165)

AS2407 COMPAIR 982628020



Overall Height: 7.56 (192)
 End 1 OD: 11.81 (300)
 End 2 OD: 8.62 (219)
 End 1 ID: 6.46 (164)

AS2408 COMPAIR 982628023



























Overall Height: 6.38 (162)
 End 1 OD: 10.04 (255)
 End 2 OD: 6.61 (168)
 End 1 ID: 4.80 (122)

AS2409 COMPAIR 982628026





















Overall Height: 7.56 (192)
 End 1 OD: 14.69 (373)
 End 2 OD: 10.79 (274)
 End 1 ID: 8.50 (216)

E. PRODUCT GUIDE





AS2410 CREYSSENSAC 11319800 Overall Height: 8.98 (228) End 1 OD: 9.25 (235) End 2 OD: 5.91 (150) End 1 ID: 3.94 (100)	AS2421 INGERSOLL-RAND 92754688  Overall Height: 9.06 (230) End 1 OD: 7.68 (195) End 2 OD: 6.65 (169) End 1 ID: 4.25 (108)	AS2430 WORTHINGTON 4110286  Overall Height: 16.46 (418) End 1 OD: 7.87 (200) End 2 OD: 6.61 (168) End 1 ID: 4.80 (122)
AS2413 BOGE 575000205  Overall Height: 12.48 (317) End 1 OD: 6.69 (170) End 2 OD: 5.28 (134) End 1 ID: 3.47 (88)	AS2422 KAESER 619630  Overall Height: 9.53 (242) End 1 OD: 7.87 (200) End 2 OD: 6.61 (168) End 1 ID: 4.80 (122)	AS2432 WORTHINGTON 41113676  Overall Height: 14.57 (370) End 1 OD: 7.87 (200) End 2 OD: 6.61 (168) End 1 ID: 4.80 (122)
AS2414 DEMAG 691674  Overall Height: 17.40 (442) End 1 OD: 10.75 (273) End 2 OD: 8.62 (219) End 1 ID: 6.50 (165)	AS2423 KAESER 619640  Overall Height: 30.00 (762) End 1 OD: 12.76 (324) End 2 OD: 10.75 (273) End 1 ID: 8.62 (219)	AS2433 WORTHINGTON 41113679  Overall Height: 14.57 (370) End 1 OD: 11.02 (280) End 2 OD: 8.62 (219) End 1 ID: 6.50 (165)
AS2415 PUROLATOR 852468  Overall Height: 26.46 (672) End 1 OD: 13.98 (355) End 2 OD: 11.73 (298) End 1 ID: 9.57 (243)	AS2424 KAESER 619650  Overall Height: 18.11 (460) End 1 OD: 12.76 (324) End 2 OD: 10.75 (273) End 1 ID: 8.62 (219)	AS2434 CREYSSENSAC 11317100, WORTHINGTON 41544  Overall Height: 7.64 (194) End 1 OD: 11.65 (296) End 2 OD: 8.62 (219) End 1 ID: 6.50 (165)
AS2417 INGERSOLL-RAND 92128883  Overall Height: 9.76 (248) End 1 OD: 6.50 (165) End 2 OD: 5.28 (134) End 1 ID: 3.47 (88)	AS2425 CREYSSENSAC 11366313, ROTORCOMP R212790788  Overall Height: 6.50 (165) Overall OD: 4.49 (114) End 1 ID: 2.60 (66) End 2 ID: 2.60 (66)	AS2435 INGERSOLL-RAND 92522135  Overall Height: 9.84 (250) End 1 OD: 6.50 (165) End 2 OD: 4.33 (110) End 1 ID: 2.36 (60)
AS2418 INGERSOLL-RAND 39737473  Overall Height: 9.84 (250) End 1 OD: 11.34 (288) End 2 OD: 8.62 (219) End 1 ID: 6.18 (157)	AS2426 CREYSSENSAC 11366413, ROTORCOMP R22270788  Overall Height: 10.16 (258) Overall OD: 4.49 (114) End 1 ID: 2.60 (66)	AS2436 COMPAIR 982628027  Overall Height: 12.48 (317) End 1 OD: 14.69 (373) End 2 OD: 10.79 (274) End 1 ID: 8.47 (215)
AS2419 COMPAIR 9826223  Overall Height: 12.48 (317) End 1 OD: 12.91 (328) End 2 OD: 10.75 (273) End 1 ID: 8.62 (219)	AS2427 ROTORCOMP R22280788  Overall Height: 13.39 (340) Overall OD: 4.49 (114) End 1 ID: 2.60 (66)	AS2437 INGERSOLL-RAND 92077601  Overall Height: 11.89 (302) End 1 OD: 6.97 (177) End 2 OD: 5.28 (134) End 1 ID: 3.47 (88)
AS2420 INGERSOLL-RAND 92722750  Overall Height: 12.01 (305) End 1 OD: 11.34 (288) End 2 OD: 8.66 (220) End 1 ID: 6.18 (157)	AS2428 WORTHINGTON 113520  Overall Height: 8.66 (220) End 1 OD: 11.73 (298) End 2 OD: 7.84 (199) End 1 ID: 5.39 (137)	AS2438 KELTEC KV85002, AIR MAZE GS39009  Overall Height: 28.25 (718) Flange Diameter: 22.00 (559) End 2 OD: 19.00 (483) End 1 ID: 16.25 (413)
	AS2429 WORTHINGTON 2180201  Overall Height: 10.63 (270) End 1 OD: 11.81 (300) End 2 OD: 8.66 (220) End 1 ID: 6.30 (160)	AS2439 AIR MAZE GS39011, KELTEC KV1300002  Overall Height: 20.25 (514) Flange Diameter: 22.00 (559) End 2 OD: 11.88 (302) End 1 ID: 9.62 (244)

E. PRODUCT GUIDE





AS2440 KELTEC KV250017 Overall Height: 13.12 (333) Flange Diameter: 11.75 (298) End 2 OD: 10.38 (264) End 1 ID: 7.88 (200)	AS2449 KAESER 620100  Overall Height: 8.29 (211) End 1 OD: 6.69 (170) End 2 OD: 5.28 (134) End 1 ID: 3.47 (88)	AS2458 TAMROCK 3340028  Overall Height: 16.28 (414) Overall OD: 3.94 (100) End 1 ID: 0.63 (16) End 2 ID: 2.15 (55)
AS2441 KELTEC KV100007 Overall Height: 9.62 (244) Flange Diameter: 11.75 (298) End 2 OD: 5.50 (140) End 1 ID: 3.62 (92)	AS2450 MANN & HUMMEL LB7192  Overall Height: 4.91 (125) Largest OD: 3.11 (79) Thread Size: M22 X 1.5-6H INT	AS2459 DEMAG 10173774  Overall Height: 15.75 (400) End 1 OD: 13.78 (350) End 2 OD: 11.73 (298) End 1 ID: 8.62 (219)
AS2442 ATLAS COPCO 1616465600  Overall Height: 14.17 (360) End 1 OD: 15.75 (400) End 2 OD: 10.32 (262) End 1 ID: 6.50 (165) Thread Size: M8 X 1.5-6G INT	AS2451 MANN & HUMMEL LB9622  Overall Height: 8.32 (211) Largest OD: 3.86 (98) Thread Size: M24 X 1.5-6H INT	AS2460 MANN & HUMMEL 4900050191  Overall Height: 20.16 (512) End 1 OD: 13.98 (355) End 2 OD: 11.73 (298) End 1 ID: 9.57 (243)
AS2443 ATLAS COPCO 1614532900  Overall Height: 13.78 (350) Overall OD: 3.94 (100) End 1 ID: 1.77 (45)	AS2452 MANN & HUMMEL LB13742  Overall Height: 7.01 (178) Largest OD: 5.51 (140) Thread Size: M39 X 1.5-6H INT	AS2461 ATLAS COPCO 2911001900  Overall Height: 21.85 (555) End 1 OD: 15.75 (400) End 2 OD: 10.35 (263) End 1 ID: 6.54 (166)
AS2444 ATLAS COPCO 1202741900  Overall Height: 13.70 (348) End 1 OD: 11.81 (300) End 2 OD: 8.66 (220) End 1 ID: 6.18 (157)	AS2453 MANN & HUMMEL LB111022  Overall Height: 10.32 (262) Largest OD: 4.35 (111) Thread Size: M32 X 1.5-6H INT	AS2462 TAMROCK 3267728  Overall Height: 10.00 (254) Overall OD: 3.13 (80) End 1 ID: 1.65 (42)
AS2445 ATLAS COPCO 2911002800  Overall Height: 11.42 (290) End 1 OD: 9.84 (250) End 2 OD: 5.28 (134) End 1 ID: 2.95 (75)	AS2454 MANN & HUMMEL LB131453  Overall Height: 12.05 (306) Largest OD: 5.51 (140) Thread Size: M39 X 1.5-6H INT	AS2463 INGERSOLL-RAND 92725514  Overall Height: 20.47 (520) End 1 OD: 17.28 (439) End 2 OD: 15.67 (398) End 1 ID: 12.36 (314)
AS2446 ATLAS COPCO 2901021300  Overall Height: 9.06 (230) End 1 OD: 11.81 (300) End 2 OD: 6.61 (168) End 1 ID: 4.25 (108)	AS2455 ATLAS COPCO 1613800700  Overall Height: 12.01 (305) End 1 OD: 15.75 (400) End 2 OD: 9.41 (239) End 1 ID: 6.97 (177)	AS2464 MANN & HUMMEL 4930252131  Overall Height: 12.01 (305) End 1 OD: 7.87 (200) End 2 OD: 6.61 (168) End 1 ID: 4.25 (108)
AS2447 KAESER 620320  Overall Height: 12.48 (317) End 1 OD: 12.76 (324) End 2 OD: 10.75 (273) End 1 ID: 8.62 (219)	AS2456 ATLAS COPCO 1614642300  Overall Height: 17.52 (445) End 1 OD: 19.69 (500) End 2 OD: 13.74 (349) End 1 ID: 10.39 (264)	AS2465 INGERSOLL-RAND 92765783  Overall Height: 19.69 (500) End 1 OD: 17.32 (440) End 2 OD: 11.73 (298) End 1 ID: 8.62 (219)
AS2448 KAESER 619470  Overall Height: 12.50 (318) End 1 OD: 7.87 (200) End 2 OD: 6.61 (168) End 1 ID: 4.80 (122)	AS2457 ATLAS COPCO 1613750200  Overall Height: 6.81 (173) End 1 OD: 9.37 (238) End 2 OD: 5.28 (134) End 1 ID: 2.95 (75)	



E. PRODUCT GUIDE

AS2466	INGERSOLL-RAND 93522902		Overall Height: 12.36 (314) End 1 OD: 7.56 (192) End 2 OD: 6.61 (168) End 1 ID: 4.80 (122)
AS2467	MANN & HUMMEL 4900050181		Overall Height: 24.09 (612) End 1 OD: 13.98 (355) End 2 OD: 11.73 (298) End 1 ID: 9.57 (243)
AS2468	ATLAS COPCO 1613839700		Overall Height: 7.09 (180) End 1 OD: 11.81 (300) End 2 OD: 6.61 (168) End 1 ID: 4.25 (108)
AS2469	HYDROVANE 59180		Overall Height: 11.26 (286) Overall OD: 2.76 (70) End 1 ID: 1.06 (27) Thread Size: M8-INT
AS2470	DEMAG 11427474		Overall Height: 20.24 (514) End 1 OD: 17.28 (439) End 2 OD: 15.67 (398) End 1 ID: 12.36 (314)
AS2471	ATLAS COPCO 1613692100		Overall Height: 6.81 (173) End 1 OD: 8.66 (220) End 2 OD: 5.28 (134) End 1 ID: 2.95 (75)
AS2472	DEMAG 10012674		Overall Height: 6.30 (160) End 1 OD: 6.69 (170) End 2 OD: 5.28 (134) End 1 ID: 2.95 (75)
AS2473	INGERSOLL-RAND 92101153		Overall Height: 10.08 (256) End 1 OD: 12.01 (305) End 2 OD: 10.79 (274) End 1 ID: 8.27 (210)
AS2474	DAF 1686587		Overall Height: 4.92 (125) End 1 OD: 2.99 (76)











AS2475	DEMAG 5482874		Overall Height: 8.35 (212) End 1 OD: 6.69 (170) End 2 OD: 5.28 (134) End 1 ID: 3.47 (88)
AS2476	DEMAG 13088474		Overall Height: 14.96 (380) End 1 OD: 7.87 (200) End 2 OD: 6.61 (168) End 1 ID: 4.25 (108)
AS2477	ATLAS COPCO 2911007500		Overall Height: 11.32 (288) End 1 OD: 6.93 (176) End 2 OD: 6.69 (170) End 1 ID: 1.13 (29) End 2 ID: 1.76 (45)
AS2478	INGERSOLL-RAND 92866508		Overall Height: 11.89 (302) End 1 OD: 6.97 (177) End 2 OD: 5.28 (134) End 1 ID: 3.47 (88)

Coolants, Chemicals and Fluid Analysis





CC2523	Fuel Sampling Kit These test kits are empty bottles that need to be filled with fuel to be tested then mailed back to our test labs in the US for analysis. If the customer can send these samples back to US then it would be OK to sell.	
CC2524	Microbicide Testing Kit These test kits are empty bottles that need to be filled with fuel to be tested then mailed back to our test labs in the US for analysis. If the customer can send these samples back to US then it would be OK to sell.	
CC2525	Monitor-Basic lube oil engine analysis kit	
CC2526	Monitor oil analysis	
CC2527	Monitor- Hydraulic fluid analysis kit	

CC2528	Monitor - Basic lube oil engine analysis kit with prepaid mailer	
CC2532	Premium Oil; 15W-40 (25 Liters)	
CC2543	Monitor - Extended lube oil drain analysis kit	
CC2544	Monitor - Engine failure lube oil analysis kit	
CC2548	Monitor - Engine lube oil and fuel dilution analysis kit	
CC2549	Asphaltene Conditioner, 5 Gal. Pail not sold in Europe.	
CC2550	Asphaltene Conditioner, 55 Gal. Drum not sold in Europe.	
CC2551	Universal EG Concentrate 6/1 Gal Jug	
CC2552	Winter Conditioner Concentrate, 5 Gal. Pail not sold in Europe.	
CC2553	Winter Conditioner Concentrate, 55 Gal. Drum not sold in Europe.	
CC2556	Universal Low Silicate EG Concentrate, 55 Gal. Drum	
CC2560	Winter Conditioner Super Concentrate, Bulk not sold in Europe.	
CC2562C	Compleat Heat Transfer Fluid EG Premix 50/50, Bulk	
CC2563C	Compleat Heat Transfer Fluid PG Concentrate, Bulk	
CC2564C	Compleat Heat Transfer Fluid PG Premix 50/50, Bulk	
CC2565C	Compleat Heat Transfer Fluid EG Premix 60/40, Bulk	
CC2566C	Compleat Heat Transfer Fluid PG Premix 60/40, Bulk	
CC2568	Compleat Heat Transfer Fluid EG Premix 50/50, 55 Gal. Drum	



E. PRODUCT GUIDE

CC2569  Compleat Heat Transfer Fluid PG Concentrate, 55 Gal. Drum	CC2596  Asphaltene Conditioner Concentrate, 2.5 Gal. Jug	CC2611  RestoreTM Cleaner , 5 Gal. Pail
CC2570  Compleat Heat Transfer Fluid PG Premix 50/50, 55 Gal. Drum	CC2597 Asphaltene Conditioner, Quart	CC2612  RestoreTM Cleaner, 55 Gal. Drum
CC2573 Compleat Heat Transfer Fluid EG Premix 40/60, Bulk	CC2598 Asphaltene Conditioner, Pint	CC2637 Restore Plus Cleaner, 55 Gal. Drum
CC2575  Base Booster, 1 Gal. Jug	CC2601  Restore, Alkaline cleaner for removing Silicate Gel Contains 3.785 Liters. Solder Corrosion and scale Replaces CC2610 in Europe. One gallon container.	CC2638 Restore Plus Cleaner, 1 Gal. Jug
CC2584 Stabeguard Urea 32, Bulk	CC2602  Coolant Test Kit, 3-Way Test Strip, 50/bottle	
CC2585 Stabeguard Urea 32, 330 Gal. Plastic Tote	CC2602A Coolant Test Kit, 4 PK 3-Way Strips	CC2650 For Upgrade, use CC2651 Monitor - Diesel fuel Go/No-Go analysis kit
CC2586 Stabeguard Urea 32, 275 Gal. Disposable Tote	CC2602B Coolant Test Kit, 100 Single 3-Way Strips	CC2651  Upgrade of CC2650 Monitor fuel analysis Diesel Fuel Quality Analysis will tell you if your diesel fuel meets ASTM D975 #2 diesel specifications.
CC2587 Stabeguard Urea 32, 55 Gal. Plastic Drum	CC2602M  Coolant Test Kit, 3-Way Test Strip, 50/bottle - Metric Version	CC2661 Microbicide, Quart
CC2588  Premium All Season Turbo Diesel Fuel Additive, Pint	CC2602AM  Coolant Test Kit, 4 PK 3-Way Strips - Metric Version	CC2661M Biocide 1 Liter not available in Europe.
CC2590 Winter Conditioner, Bulk not sold in Europe.	CC2609  Water-ChekTM Test Strip, 100/box	CC2663 Microbicide, 1 Gal. Jug
CC2591 Winter Conditioner, Pint not sold in Europe.	CC2610  Restore Cleaner, 1 Gal. Jug	CC2663M Biocide 4 Liter - Single. Not available in Europe.
CC2592 Winter Conditioner, Quart not sold in Europe.		CC2674 Fleetcool EG Recycled Premix 50/50, Bulk
CC2593 Winter Conditioner, 5 Gal. Pail not sold in Europe.		CC2675 Fleetcool EG Recycled Premix 50/50, 55 Gal. Drum
CC2594 Winter Conditioner, 55 Gal. Drum not sold in Europe.		CC2677 Universal Premix 50/50 Recycled, Bulk
CC2595 Winter Conditioner Super Concentrate, 2.5 Gal. Jug not sold in Europe.		CC2678 Universal Premix 50/50 Recycled, 55 Gal. Drum
		CC2682 Flash Rust Inhibitor DCA-DX 55 Gallon Drum

E. PRODUCT GUIDE

CC2684	Flash Rust Inhibitor DCA-DX Gallon	CC2728	Compleat EG 50/50 Premix (5 gal. pail). Use CC2848 ES Compleat EG Premix in North America.	CC2758	Universal Light Duty PG Concentrate, 55 Gal. Drum (No DCA4)
CC2691	Winter Conditioner, Pint, 1 Skid (960 Pints)	CC2729	Compleat PG Concentrate (5 gal. pail). Use CC2849 ES Compleat PG Concentrate in North America.	CC2765	Fleetcool EX Extender- 1 Quart
CC2692	Winter Conditioner, Quart, 1 Skid (720 Quarts)	CC2730	Compleat PG 50/50 Premix (5 gal. pail). Use CC2850 ES Compleat PG Premix in North America.	CC2766	Platinum Plus DFX Fuel Borne Catalyst 5 Gallon Pail
CC2693	Winter Conditioner, 5 Gal. Pail, 1 Skid (36 Pails)	CC2739	Fleetcool EX EG Concentrate, Bulk	CC2767	Platinum Plus DFX Fuel Borne Catalyst Gallon
CC2694	Winter Conditioner, 55 Gal. Drum, 1 Skid (4 Drums)	CC2740	Fleetcool EX EG Concentrate, 275 Gal. Tote 	CC2770	ES Optimax EG Premix 60/40, 55 Gallon Drum
CC2695	Winter Conditioner, 2.5 Gal. Jug, 1 Skid (72 Jugs)	CC2741	Fleetcool EX EG Concentrate, 55 Gal. Drum	CC2771	Platinum Plus DFX Fuel Borne Catalyst 55 gallon Drum
CC2696	Asphaltene Conditioner, 2.5 Gal. Jugs, 1 Skid (72 Jugs)	CC2742	Fleetcool EX EG Concentrate, 6/1 Gal. Jug	CC2772	Platinum Plus DFX-DPF Fuel Borne Catalyst 5 Gallon Pail
CC2697	Asphaltene Conditioner, Quart, 1 Skid (720 Quarts)	CC2743	Fleetcool EX EG Premix 50/50, Bulk	CC2773	Platinum Plus DFX-DPF Fuel Borne Catalyst Gallon
CC2699	Turbo Diesel Fuel Additive in pint size for pallet quantity 960 pints	CC2743W	Fleetcool EX EG Premix- Bulk	CC2777	ES Optimax™ Extender, Pint
CC2700	Monitor C - Coolant/ heat transfer fluid analysis kit	CC2744	Fleetcool EX EG Premix 50/50, Tote	CC2779	ES Optimax Extender, Quart
CC2706	Monitor C - Coolant/ heat transfer fluid analysis kit 	CC2745	Fleetcool EX EG Premix 50/50, Drum	CC2780	ES Optimax EG Concentrate, 6/1 Gal. Jug
CC2714	Flash Rust Inhibitor DCA-DX 275 Gallon Tote	CC2746	Fleetcool EX EG Premix 50/50, 6/1 Gal. Jug	CC2782	ES Optimax EG Concentrate, 55 Gal. Drum
CC2717	Coolant Test Kit Monitor for US and Canada 	CC2747M	ES Compleat EG Concentrate - 5L	CC2783	ES Optimax EG Concentrate , 275 Gal. Tote
CC2718	Quik-Chek bottle of 10 Test Strips 	CC2748M	ES Compleat EG 50/50 Premix - 5L	CC2784	ES Optimax EG Concentrate, Bulk
CC2719	Fuel Analysis Test Kit	CC2749M	ES Compleat EG Concentrate - 20L	CC2785	ES Optimax EG Premix 50/50, 6/1 Gal. Jug
CC2723	Vacuum Pump	CC2750M	ES Compleat EG 50/50 Premix - 20L	CC2787	ES Optimax EG Premix 50/50, Drum
CC2724	Quickdraw Valve	CC2751M	ES Compleat PG Concentrate - 5L	CC2788	ES Optimax EG Premix 50/50, Tote
CC2727	Compleat EG Concentrate (5 gal. pail) Use CC2847 ES Compleat EG Concentrate in North America.	CC2752M	ES Compleat PG 50/50 Premix - 5L	CC2789	ES Optimax EG Premix 50/50, Bulk
		CC2753M	ES Compleat PG Concentrate - 20L	CC2790	ES Optimax EG Premix 60/40, Tote
		CC2754M	ES Compleat PG 50/50 Premix - 20L	CC2792	Compleat Propylene Glycol 60/40 Premix Antifreeze Coolant - 55 gallon drum-- Superseded by ES Compleat PG Premix 60/40 in North America
		CC2757	Universal Light Duty PG Concentrate, 6/1 Gal. (No DCA4)	CC2799C	Compleat EG Concentrate Bulk
				CC2802	Uses service part: 3899452S Monitor - Fluid sampling vacuum pump tool kit 

E. PRODUCT GUIDE

CC2806  Uses service part: 3930708S Refractometer	CC2837C ES Compleat PG Premix 50/50, Bulk	CC2863 ES Compleat EG Premix 60/40, 55 Gal. Drum
CC2817 Flash Rust Inhibitor DCA DX Bulk	CC2837M ES Compleat PG 50/50 Premix bulk	CC2865 ES Compleat PG Premix 60/40, 55 Gal. Drum
CC2820 ES Compleat EG Concentrate, 6/1 Gal. Jug	CC2838 Uses service part: 3918034S ES Compleat PG Premix 50/50, 275 Gal. Tote	CC2866 20,000ltr Bulk PGPlus Premix Coolant
CC2821 ES Compleat EG Concentrate, 55 Gal. Drum	CC2840 ES Extender, Quart	CC2867 1,000ltr PGPlus Premix Coolant
CC2821M ES Compleat EG Concentrate - 208L	CC2841 ES Extender, 55 Gal. Drum	CC2868 208ltr PGPlus Premix Coolant
CC2822C ES Compleat EG Concentrate, Bulk	CC2842 ES Extender, 5 Gal. Pail	CC2869 20ltr PGPlus Premix Coolant
CC2822M ES Compleat EG bulk Concentrate	CC2843 ES Extender, Pint 	CC2870 4ltr PGPlus Premix Coolant
CC2823 Uses service part: 3918034S ES Compleat EG Concentrate, 275 Gal. Tote	CC2847 ES Compleat EG Concentrate, 5 Gal. Pail	CC2872 ES Compleat PG Premix 60/40, 275 Gal. Tote
CC2825 ES Compleat EG Premix 50/50, 6/1 Gal. Jug	CC2848 ES Compleat EG Premix 50/50, 5 Gal. Pail	CC2878 Fleetcool EG Concentrate Gallon
CC2826 ES Compleat EG Premix 50/50, 55 Gal. Drum	CC2849 ES Compleat PG Concentrate, 5 Gal. Pail	CC2883C EG Fleetcool Concentrate Bulk
CC2826M ES Compleat EG 50/50 Premix - 208L	CC2850 ES Compleat PG Premix 50/50, 5 Gal. Pail	CC2891  Monitor - Engine lube oil viscosity analysis kit
CC2827 ES Compleat EG Premix 50/50, Bulk	CC2851M ES Compleat EG Concentrate - 1000L	CC2895C Compleat PG Concentrate Bulk
CC2827M ES Compleat EG - 50/50 Premix - bulk	CC2852M ES Compleat EG 50/50 Premix - 1000L	CC2896C Compleat PG Premix Bulk
CC2830 ES Compleat PG Concentrate, 6/1 Gal. Jug	CC2853M ES Compleat PG Concentrate - 1000L - IBC	CC2899C Compleat EG Premix Bulk
CC2831 ES Compleat PG Concentrate, 55 Gal. Drum	CC2854M ES Compleat PG - 50/50 Premix - 1000L IBC	CC8948 Can
CC2831M ES Compleat PG Concentrate - 208L	CC2858 Uses service part: 3918034S Compleat EG Concentrate (275 gal disposable tote). Use CC2823 ES Compleat EG Concentrate in North America	CC8951 ES Complete EG 40/60 275 Gallon Tote
CC2832C ES Compleat PG Concentrate, Bulk	CC2859 Uses service part: 3918034S Compleat EG 50/50 Premix (275 gal disposable tote). Use CC2834 ES Compleat EG Premix in North America	CC8965 Fleetcool EG Concentrate Bulk
CC2832M ES Compleat PG Concentrate bulk	CC2860 Uses service part: 3918034S Compleat PG Concentrate (275 gal disposable tote). Use CC2833 ES Compleat PG Concentrate in North America	CC8966 Fleetcool EG Concentrate Tote
CC2833 Uses service part: 3918034S ES Compleat PG Concentrate, 275 Gal. Tote	CC2861 Uses service part: 3918034S Compleat PG 50/50 Premix (275 gal disposable tote). Use CC2836 ES Compleat PG Premix in North America.	CC8967 Fleetcool EG Concentrate Drum
CC2834 Uses service part: 3918034S ES Compleat EG Premix 50/50, 275 Gal. Tote		CC8968 Fleetcool EG Concentrate Pail
CC2835 ES Compleat PG Premix 50/50, 6/1 Gal. Jug		CC8969 Fleetcool EG Concentrate Gal
CC2836 ES Compleat PG Premix 50/50, 55 Gal. Drum		CC8970 Fleetcool Premix 50/50 Bulk
CC2836M ES Compleat PG - 50/50 Premix - 208L		CC8971 Fleetcool Premix 50/50 Tote
		CC8972 Fleetcool Premix 50/50 Drum
		CC8973 Fleetcool Premix 50/50 Pail

E. PRODUCT GUIDE

CC8974	Fleetcool Premix 50/50 Gal
CC8983	ES Complete EG Premix Disposable Tote
CC8984	ES Complete EG Concentrate Disposable Tote
CC36000	ES Compleat Glycerin Premix gallons
CC36001	ES Compleat Glycerin Premix pails
CC36002	ES Compleat Glycerin Premix drums
CC36003	ES Compleat Glycerin Premix totes
CC36004	ES Compleat Glycerin Premix bulk
CC36049	ES Compleat Glycerin Premix service tool: Brix refractometer

CC36050	ES Compleat Glycerin Premix 2-way test strip
----------------	--



CC36050B	ES Compleat Glycerin Premix single test strip
-----------------	---



Centrifuge Lube Filters

CH41100	Uses service part: 3935261S, 3935262S, 3935293S, CS41005 Centrifugal By-Pass Lube Filter
	Overall Height: 11.31 (287) Assisted Drain: NO Overall Length: 6.53 (166) Overall Width: 7.38 (187) Thread Inlet: M22 X 1.5-6G INT Thread Outlet: 1 5/8-12 UN-2B



CH41101	Uses service part: 3935262S, 3940750S, 3940756S, 3941519S, 3943071S, CS41007 Gpm Air-Assisted Drain Centrifuge
	Overall Height: 11.32 (288) Assisted Drain: YES Overall Length: 6.53 (166) Overall Width: 7.39 (188) Thread Inlet: M22 X 1.5-6H INT Thread Outlet: 1/2 NPT

CH41102	Filter used with 3944520S Uses service part: 3935262S, 3940750S, 3940756S, CS41007 Centrifugal By-Pass Lube Filter. Generic use for lube systems typically on diesel engines able to support 1 GPM bypass flow (supply air is not required on this unit.)
	Overall Height: 11.31 (287) Assisted Drain: NO Overall Length: 6.53 (166) Overall Width: 7.38 (187) Thread Inlet: M22 X 1.5-6H INT Thread Outlet: 1 5/8-12 UN-2B



CH41111	Filter used with 3951366S Uses service part: 3943871S, 3950689S, CS41011 Remote mounted with gravity drain.
	Overall Height: 14.30 (363) Assisted Drain: NO Overall Length: 6.53 (166) Overall Width: 7.38 (188) Thread Inlet: M22 X 1.5-6G INT Thread Outlet: 1 5/8-12 UN-2B



CH41112	Filter used with 3951367S Uses service part: 3940750S, 3940756S, 3941519S, 3943071S, 3943871S, 3950690S, CS41011 Remote-mount, air assisted centrifuge
	Overall Height: 14.28 (363) Assisted Drain: YES Overall Length: 6.53 (166) Overall Width: 7.38 (188) Thread Inlet: M22 X 1.5-6G INT Thread Outlet: 1 5/8-12 UN-2B



CH41113	Filter used with 3955640S Uses service part: 3943871S, 3950689S, CS41016 Remote mounted with gravity drain.
	Overall Height: 14.30 (363) Assisted Drain: NO Overall Length: 6.53 (166) Overall Width: 7.38 (188) Thread Inlet: M22 X 1.5-6G INT Thread Outlet: 1 5/8-12 UN-2B

CH41114	Filter used with 3955641S Uses service part: 3941519S, 3943071S, 3943871S, 3950690S, CS41016 Remote-mount, air assisted centrifuge
	Overall Height: 14.30 (363) Assisted Drain: NO Overall Length: 6.53 (166) Overall Width: 7.38 (188) Thread Inlet: M22 X 1.5-6G INT Thread Outlet: 1 5/8-12 UN-2B



CH44105	CUMMINS 3332056 Uses service part: 3894971S, 3894975S, 3894976S, 3894977S, 3915993S, 3916910S, 3916911S, 3917128S, 3917161S, CS44000 Uses Service gasket: 3894973S, 3894972S Centrifugal By-Pass Lube Filter
	Height: 14.50 (368) Base OD: 8.80 (224) Housing OD: 7.80 (198)



CH44110	Uses service part: 3894975S, 3894976S, 3915993S, 3916004S, 3916910S, 3916911S, CS44000 Uses Service gasket: 3894973S, 3894972S Centrifugal By-Pass Lube Filter
----------------	--



CH44115	Uses service part: 3894975S, 3894976S, 3915993S, 3916004S, 3916910S, 3916911S, CS44000 Uses Service gasket: 3894973S Centrifugal By-Pass Lube Filter
	Housing OD: 7.48 (190)



CH44120	Uses service part: 3894975S, 3894977S, 3915993S, 3916910S, 3916911S, 3917129S, CS44000 Uses Service gasket: 3894973S, 3894972S Centrifugal By-Pass Lube Filter - Side Drain
	Height: 15.10 (384) Base OD: 9.00 (229)



Centrifuge Replacement Rotors

CS41000	MACK 57GC286 Filter used with 485GB3219D ConeStaC for Centrifugal By-Pass Filters
	Overall Height: 4.98 (127) Overall OD: 3.85 (98)



CS41001	DAF 1376481
	Overall Height: 4.98 (127) Overall OD: 3.85 (98)



CS41002	ROLLS ROYCE OE45353
	Overall Height: 5.02 (127) Overall OD: 3.85 (98)



CS41003	RENAULT V.I. 5010437143
	Overall Height: 4.98 (127) Overall OD: 3.85 (98)



CS41004	RENAULT V.I. 5001853256
	Overall Height: 4.98 (127) Overall OD: 3.85 (98)



E. PRODUCT GUIDE

CS41005 MACK 236GB245M Used with CH41100



Overall Height: 4.98 (127)
Overall OD: 3.85 (98)

CS41007 Used with CH41101, CH41102
1 gpm version of CS41005-
Identical except for the nozzle
size which adjusts the flow
rate.



Overall Height: 4.98 (127)
Overall OD: 3.85 (98)

CS41008 Disposable Centrifuge Rotor



Overall Height: 5.78 (147)
Overall OD: 3.88 (99)

CS41010 MACK 57GC2206



Gasket: 3933345
Overall Height: 7.44 (189)
Overall OD: 4.29 (109)

CS41011 Used with CH41111, CH41112
2 gpm Service Rotor & Gasket



Overall Height: 7.44 (189)
Overall OD: 4.29 (109)

CS41013 INTERNATIONAL TRUCKS
1842825C91 Disposable
Centrifuge Assembly. Applied
on 2004 International 466 and
570 engines.



Overall Height: 7.44 (189)
Overall OD: 4.29 (109)

CS41016 Used with CH41113, CH41114
1 gpm Service Rotor & Gasket



Overall Height: 7.44 (189)
Overall OD: 4.29 (109)

CS44000 Used with CH44110,
CH44115, CH44120, CH44105
ConeStac for Centrifugal By-
Pass Filters



Largest OD: 5.72 (145)
End 1 OD: 5.72 (145)
End 2 OD: 0.00 (0)
End 1 ID: 5.55 (141)
End 2 ID: 5.42 (138)

Crankcase Ventilators

CV50000 Breather Assembly only for
CV50109 System

CV50001 Breather Assembly only for
CV50108 System

CV50002 Breather Assembly only for
CV50110 System

CV50004 Breather Assembly only for
CV50111 System



CV50006 System for all Cummins B,
ISB, C, ISC, and L engines



CV50015 System for 1998-2002 Dodge
Ram Turbo 5.9L engine
applications



CV50051 Breather Assembly and
bracket only for CV50203
System



CV50053 Breather Assembly and
bracket only for CV50204
System



CV50054 Breather Assembly and
bracket only for CV50205
System



CV50108 System for 60-90 HP. Non-
Cummins engine applications



CV50109 System for 91-120 HP. Non-
Cummins engine applications



CV50110 System for 121-160 HP. Non-
Cummins engine applications



CV50111 System for 161-220 HP. Non-
Cummins engine applications



CV50112 System for 221-300 HP. Non-
Cummins engine applications



CV50113 Open crankcase ventilation
(OCV). Use with International
466 & 530 engines; Single
impactor CV50006



CV50114 Open crankcase ventilation
(OCV). Use with Cummins
M11 engine; Single impactor
CV50006



CV50115 Open crankcase ventilation
(OCV). Use on Dodge Ram
pickup truck with Cummins ISB
engine. Model years 1998-
2002; Single impactor
CV50005



CV50116 Open crankcase ventilation
(OCV). Use with Cummins ISC
& ISL engines; Single
impactor CV50006













CV50117 Open crankcase ventilation
(OCV). Use with Cummins ISB
engine; Single impactor
CV50005



CV50200 System for Cummins M11
engine applications Include
Bracket for Installation







CV50201	Open crankcase ventilation (OCV). Use with Cummins N14 engine; Dual impactor CV50053. Includes mounting bracket
	
CV50202	Open crankcase ventilation (OCV). Use with Cummins ISX and QSX diesel engines. Dual impactor CV50053. Includes mounting bracket
	
CV50203	Open crankcase ventilation (OCV). Use with diesel engine application between 301-400 HP; Dual impactor CV50051. Includes mounting bracket
	
CV50204	Open crankcase ventilation (OCV). Use with diesel engine application between 401-525 HP; Dual impactor CV50053. Includes mounting bracket
	
CV50205	Open crankcase ventilation (OCV). Use with diesel engine application between 525-640 HP. Dual impactor CV50054. Includes mounting bracket
	
CV50601	CUMMINS 3683918 OCV Element Assembly used on Cummins ISX/ISM engines.
	
CV50603	CUMMINS 4939749 OCV Service Element used on Cummins ISC/ISL engines.
	
CV51118	Kit consists of: Q618145 Drain assembly, LT32668 CCV Coalescer kit installation instructions, CV50612 Coalescer assembly, 3955875 CDR Valve assembly, Q158110 CDR assembly mounting bracket
	
CV52000	CUMMINS 4932168, CHRYSLER 68002433AA OCV Breather Assembly used on Cummins ISB engines.
	
CV52001	CUMMINS 4936636 OCV Breather Assembly used on Cummins ISB engines.
	

Cooling System Aids

DCA30L	DCA2, Pint
---------------	------------

DCA35L	DCA2, 1/2 Gal Jug
DCA40L	DCA2, 1Gal Jug
DCA45L	DCA2, 5 Gal. Pail
DCA50L	DCA2, 55 Gal. Drum
DCA60L	DCA4, Pint
	
DCA65L	DCA4, 1/2 Gal Jug
DCA70L	DCA4, 1Gal Jug
DCA75L	DCA4 Pail
DCA80L	DCA4, 55 Gal. Drum

Fuel Filters

FF101	CUMMINS 105211, CUMMINS 299101 Uses service part: 105208S
	Gasket: 250382 ¹⁰ , 250389 ¹⁰ , 3844190, 3844191 Overall Height: 4.85 (123) Overall OD: 3.97 (101) End 1 ID: 0.77 (20)
FF102	CUMMINS 44758, CUMMINS 299102 For lube application use LF503
	Gasket: 250420 Overall Height: 5.95 (151) Overall OD: 3.95 (100) End 1 ID: 1.08 (27)
FF103	CUMMINS 299103
	Gasket: 250938 Overall Height: 7.66 (195) Overall OD: 3.01 (76) End 1 ID: 1.04 (26)
FF104	CUMMINS 138627 Filter used with 142784S, 212013S For Upgrade, use FF5334, FF105
	Gasket: 255622, 3301519 ¹⁰ Overall Height: 4.15 (105) Largest OD: 3.70 (94) Thread Size: 1-14 UNS-2B

FF105	CUMMINS 154709 Filter used with 142784S, 212013S, 3911894S, 3930618S Is a short version of FF213 Uses service part: 154711S, 255622S Upgrade of FF104 For Upgrade, use FS1212, FF5332 Extended Life Version of FF104 w/o drain For Synthetic Media Version use FF5332
	Gasket: 255622, 3301519 ¹⁰ Overall Height: 5.41 (137) Largest OD: 3.70 (94) Thread Size: 1-14 UNS-2B

FF105C	CUMMINS 202893 Filter used with 142784S Extended Life Version of FF104 w/ drain cock
	Gasket: 255622, 3301519 ¹⁰ Overall Height: 6.24 (159) Largest OD: 3.70 (94) Thread Size: 1-14 UNS-2B

FF105D	CUMMINS 156172 Filter used with 142784S Uses service part: 156171S, 255622S Extended Life Version of FF104 w/ drain plug
	Gasket: 255622, 3301519 ¹⁰ Overall Height: 6.02 (153) Largest OD: 3.70 (94) Thread Size: 1-14 UNS-2B

FF106	CASE A31222 Uses service part: 250394S Primary Fuel in some applications
	Gasket: 250394, 250938, 254503 ¹¹ , 254504 ¹¹ , 3304298 ¹⁰ Overall Height: 5.71 (145) Overall OD: 3.01 (76) End 1 ID: 1.04 (26)

FF106A	CASE A31222 Sock Version of FF106
	Overall Height: 6.00 (152) Overall OD: 3.00 (76) End 1 ID: 1.02 (26)

FF107	MACK 237GB13 Uses service part: 250383, 250383S
	Gasket: 250383 Overall Height: 6.29 (160) Overall OD: 3.95 (100) End 1 ID: 0.91 (23)

FF108	CUMMINS 139097, CUMMINS 256834 Uses service part: 151884S, 151940S, 250843S, 251081S, 251091S, 251390S, 3302009S, 3303210S
	Gasket: 250413 ¹⁰ , 251390 Overall Height: 9.98 (253) Overall OD: 5.83 (148) End 1 ID: 0.99 (25)

E. PRODUCT GUIDE

FF109

FIAT-ALLIS 74056633, CASE A7627, GMC 5573261 Uses service part: 250394S



Gasket: 250394, 250938, 254503¹¹
Overall Height: 3.24 (82)
Overall OD: 3.01 (76)
End 1 ID: 1.04 (26)

FF110

GMC 5573262, KOMATSU 88913 Uses service part: 250394S



Gasket: 250394, 250938, 254503¹¹, 254504¹¹
Overall Height: 7.75 (197)
Overall OD: 3.01 (76)
End 1 ID: 1.04 (26)

FF111

GMC 9717391, GMC 5575032, CASE 998446R91 Uses service part: 250394S Primary Fuel in some applications



Gasket: 250394, 254503¹¹, 256076¹¹
Overall Height: 8.25 (210)
Overall OD: 3.00 (76)
End 1 ID: 1.20 (30)

FF112

GMC 5574980



Gasket: 250389
Overall Height: 8.75 (222)
Overall OD: 4.00 (102)
End 1 ID: 1.25 (32)

FF113

CONTINENTAL 12395HE



Overall Height: 9.70 (246)
Overall OD: 3.01 (76)
End 1 ID: 1.04 (26)

FF114

Chrysler, Ford, GM Trucks

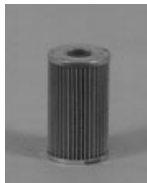

Gasket: 320694
Overall Height: 3.46 (88)
Overall OD: 2.05 (52)
End 1 ID: 0.40 (10)

FF115

Fram F-1127-APB Series



Gasket: 3842850, 3842851, 3842852
Overall Height: 7.66 (195)
Overall OD: 3.01 (76)
End 1 ID: 1.04 (26)

FF116

CATERPILLAR 4H8792, CATERPILLAR 9H4729 use two elements to replace 6H-5932, 9H-1252



Gasket: 251301¹², 251302¹², 251303¹², 251304¹²
Overall Height: 6.45 (164)
Overall OD: 3.35 (85)
End 1 ID: 1.06 (27)

FF117

CASE A57228



Overall Height: 6.41 (163)
Largest OD: 3.81 (97)
Thread Size: 1/4-18 NPTF

FF122

Caterpillar Equipment Use One Cartridge To Replace Caterpillar 7B-8261 Use Three Cartridges To Replace Caterpillar 7B-8262, 1F1660 Use Four Cartridges To Replace Caterpillar 7B-8264, 1F1662 Use Five Cartridges To Replace Caterpillar 3H-9701 Use Six Cartridges To Replace Caterpillar 7B-8259, 1F1661 Use Nine Cartridges To Replace Caterpillar 7B-8263, 1F1663 Use Twelve Cartridges To Replace Caterpillar 7B8260, 1F1664

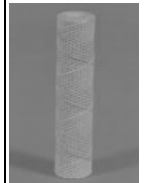

FF125

CUMMINS 130909, CUMMINS 299125 Uses service part: 3307532S, 3316705S



Gasket: 250645¹⁰, 252943¹⁰, 257495¹⁰
Overall Height: 8.23 (209)
Overall OD: 4.99 (127)
End 1 ID: 0.99 (25)
End 2 ID: 1.13 (29)

FF126

IH 250332-R91, 259479-R91, 266839-R91, 279980-R91



Gasket: 3310171
Overall Height: 6.78 (172)
Overall OD: 3.47 (88)
End 1 ID: 0.55 (14)

FF127

GMC 5574979 Uses service part: 3832879S



Gasket: 256076, 3831246, 3832879
Overall Height: 8.69 (221)
Overall OD: 4.33 (110)
End 1 ID: 0.68 (17)

FF130

JOHN DEERE AR344R, JOHN DEERE AR471R, JOHN DEERE AR28611R



Gasket: 3300986
Overall Height: 4.19 (106)
Overall OD: 3.45 (88)
End 1 ID: 0.75 (19)

FF134

MACK 237GB28, CASE 304101R91



Gasket: 250383
Overall Height: 4.46 (113)
Overall OD: 3.37 (86)
End 1 ID: 1.06 (27)

FF135

ALLIS-CHALMERS 4348147, ALLIS-CHALMERS 4048147, CLARK 940107, KOHLER 285333, ONAN 149B846, WAUKESHA 155235



Gasket: 250457
Overall Height: 4.34 (110)
Overall OD: 3.50 (89)
End 1 ID: 0.54 (14)

FF137

CASE 62946DA

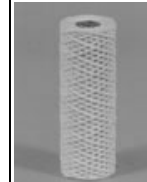

Gasket: 255326
Overall Height: 6.85 (174)
Overall OD: 2.45 (62)
End 1 ID: 1.13 (29)

FF138

CASE G45288, FORD C3T29365B



Overall Height: 2.88 (73)
Overall OD: 3.39 (86)
End 1 ID: 0.70 (18)
End 2 ID: 0.58 (15)

FF139

GMC 854347



Overall Height: 1.08 (27)
Overall OD: 1.75 (44)
End 1 ID: 0.47 (12)

FF140

MURPHY MD13924A



Overall Height: 36.81 (935)
Largest OD: 2.38 (60)
Thread Size: 1/4 NPT

FF141

FIAT-ALLIS 74040474, FIAT-ALLIS 74055565 Fiat-Allis 7069947



Gasket: 250938
Overall Height: 8.70 (221)
Overall OD: 3.01 (76)
End 1 ID: 1.04 (26)







FF142

ALLIS-CHALMERS 4052172



























Gasket: 250938
Overall Height: 7.66 (195)
Overall OD: 3.01 (76)
End 1 ID: 1.04 (26)

E. PRODUCT GUIDE

<p>FF144 AC FF23</p>  <p>Gasket: 252247 Overall Height: 3.37 (85) Overall OD: 2.75 (70) End 1 ID: 0.81 (21)</p>	<p>FF157 Includes 4 clamps, 2 hoses, and 1 gasket</p>  <p>Overall Height: 3.89 (99) Inlet Connection: 3/8 HOSE Outlet Connection: 3/8 HOSE Largest element OD: 1.91 (49)</p>	<p>FF175 CASE 259099C91</p>  <p>Overall Height: 5.48 (139) Largest OD: 3.69 (94) Thread Size: 5/8-11 UNC-2B</p>
<p>FF145 MASSEY-FERGUSON 1012006M1, PERKINS 31938</p>  <p>Gasket: 252395 Overall Height: 2.75 (70) End 1 OD: 3.50 (89) End 2 OD: 3.47 (88) End 1 ID: 0.75 (19)</p>	<p>FF161 Ford Family Cars And Trucks In-Line Fuel</p>  <p>Overall Height: 3.78 (96) Inlet Connection: 1/8 NPT Outlet Connection: .315 Largest element OD: 1.91 (48)</p>	<p>FF178 CUMMINS 256835 Filter used with 252193, 252193S Uses service part: 252598S, 3302102S</p>  <p>Gasket: 252598 Overall Height: 9.77 (248) Overall OD: 5.83 (148) End 1 ID: 0.99 (25)</p>
<p>FF146 MERCEDES-BENZ 4773815 Uses service part: 3323007S, 3323009S, 3323010S</p>  <p>Gasket: 3323007¹⁰, 3323009¹⁰, 3323010¹⁰ Overall Height: 4.53 (115) Overall OD: 2.55 (65) End 1 ID: 0.54 (14)</p>	<p>FF164 GALION D73246, KOMATSU 73246</p>  <p>Gasket: 3826211 Overall Height: 5.99 (152) Largest OD: 3.69 (94) Thread Size: 13/16-16 UNS-2B</p>	<p>FF179 FORD C5U9155A</p>  <p>Overall Height: 2.85 (72) Inlet Connection: 1/8 - 21 NPTF Outlet Connection: 0.312 Largest element OD: 0.94 (24)</p>
<p>FF147 CASE 3132015R92 Uses service part: 3323008S, 3323009S, 3324564S</p>  <p>Gasket: 3323008¹⁰, 3324564¹⁰ Overall Height: 5.71 (145) Overall OD: 3.28 (83) End 1 ID: 0.54 (14)</p>	<p>FF167 CAV (LUCAS-CAV) 7111296 Pleated Paper Version</p>  <p>Gasket: 3321299, 3321300, 3321302 Overall Height: 2.84 (72) End 1 OD: 3.47 (88) End 2 OD: 3.31 (84) End 1 ID: 0.74 (19) End 2 ID: 1.50 (38)</p>	<p>FF180 GMC 5651393, AC GF427, GMC 5651920 One Inch Carb. Element</p>  <p>Overall Height: 1.03 (26) Overall OD: 0.70 (18) End 1 ID: 0.29 (7)</p>
<p>FF148 ALLIS-CHALMERS 40487894, CASE 368257R91, CASE 368278R91</p>  <p>Gasket: 250419 Overall Height: 4.11 (104) Overall OD: 2.96 (75) End 1 ID: 0.54 (14)</p>	<p>FF167A Rolled Paper Version See FF167 for application Bosch</p>  <p>Gasket: 3321299, 3321300, 3321302 Overall Height: 2.80 (71) End 1 OD: 3.48 (89) End 2 OD: 3.31 (84) End 1 ID: 0.75 (19) End 2 ID: 0.67 (17)</p>	<p>FF182 WHITE 400002510</p>  <p>Overall Height: 6.91 (176) Largest OD: 3.73 (95) Thread Size: 7/8-14 UNS-2B</p>
<p>FF149 In Line Fuel</p>  <p>Overall Height: 3.96 (100) Inlet Connection: 0.386 IN. Outlet Connection: 0.386 IN. Largest element OD: 2.00 (51)</p>	<p>FF171 MACK 483GB218B For Upgrade, use FF5347</p>  <p>Overall Height: 8.11 (206) Largest OD: 4.26 (108) Thread Size: 7/8-16 UN-2B</p>	<p>FF183 CATERPILLAR 9L9100</p>  <p>Overall Height: 5.42 (138) Largest OD: 3.69 (94) Thread Size: 15/16-16 UN-2B</p>
<p>FF150 MACK 237GB21 Not available in all parts of the world.</p>  <p>Gasket: 252897 Overall Height: 6.23 (158) Largest OD: 2.96 (75) Thread Size: 3/4-16 UNF-2A</p>	<p>FF172 MACK 483GB219A For Upgrade, use FS1219</p>  <p>Overall Height: 8.11 (206) Largest OD: 4.26 (108) Thread Size: 13/16-18 UNS-2B</p>	<p>FF184 THERMO-KING 113854</p>  <p>Overall Height: 8.78 (223) Largest OD: 3.73 (95) Thread Size: 1-14 UNS-2B</p>
<p>FF155 FORD C0DZ9155A</p>  <p>Overall Height: 3.45 (88) Inlet Connection: 1/8-27 NPT-2A Outlet Connection: 1/2-20 UNF-2B Largest element OD: 2.00 (51)</p>	<p>FF174 CASE 318887C91 Not available in all parts of the world.</p>  <p>Overall Height: 4.92 (125) Overall OD: 4.50 (114) End 1 ID: 1.06 (27)</p>	<p>FF185 CATERPILLAR 1P2299 For Upgrade, use FS1214, FF5336</p>  <p>Overall Height: 6.94 (176) Largest OD: 3.68 (93) Thread Size: 1-14 UNS-2B</p>























E. PRODUCT GUIDE

FF187  FIAT-ALLIS 74056632 Gasket: 255134 Overall Height: 7.97 (202) Overall OD: 2.70 (69) End 1 ID: 1.07 (27)	FF200  CASE A58712 Overall Height: 6.47 (164) Largest OD: 3.69 (94) Thread Size: 13/16-18 UNS-2B	FF211  CATERPILLAR 4N5823 For Upgrade, use FS1218 Overall Height: 10.44 (265) Largest OD: 4.26 (108) Thread Size: 1-14 UNS-2B
FF188  CASE 306353R91 Previously cotton, now metal. Overall Height: 4.80 (122) Overall OD: 2.64 (67) End 1 ID: 1.17 (30)	FF201  FIAT-ALLIS 74025230, CASE A58713 Overall Height: 5.42 (138) Largest OD: 3.69 (94) Thread Size: 15/16-16 UN-2B	FF213  CUMMINS 3300901 Filter used with 142784S, 212013S Is a longer version of FF105 Extended Life Version Gasket: 255622, 3301519 ¹⁰ Overall Height: 6.91 (176) Largest OD: 3.77 (96) Thread Size: 1-14 UNS-2B
FF191  CASE 967640R21 Uses service part: 3308112S Gasket: 320699 ¹⁰ , 323413 ¹² Overall Height: 1.88 (48) Overall OD: 1.39 (35) End 1 ID: .5 (13)	FF202  CUMMINS 299202 Filter used with 3302367S Uses service part: 3304274S For Upgrade, use FS1216, FF5346 Overall Height: 11.31 (287) Largest OD: 4.74 (120) Thread Size: 1 1/4-12 UNS-2B	FF214  KOMATSU 3132428R2, FURUKAWA 3381442H1 Overall Height: 6.75 (171) Largest OD: 3.05 (77) Thread Size: M16 X 1.5-6H INT
FF192  CASE 702253C1 Overall Height: 6.91 (176) Largest OD: 3.70 (94) Thread Size: 1-14 UNS-2B	FF203  JOHN DEERE AR50041 Height: 3.31 (84) Length: 4.96 (126) Width: 3.71 (94)	FF215  BOSCH 1457434056 Gasket: 331231 Overall Height: 6.75 (171) Largest OD: 3.05 (77) Thread Size: M16 X 1.5-6H INT
FF194  CASE 702256C1 Overall Height: 7.67 (195) Largest OD: 3.72 (94) Thread Size: 1-14 UNS-2B	FF204  THERMO-KING 113693 Overall Height: 5.46 (139) Largest OD: 3.69 (94) Thread Size: 7/8-14 UNF-2B	FF216  CLARK FJ2S, VOLVO 7952104 Overall Height: 6.91 (176) Largest OD: 3.69 (94) Thread Size: 1-12 UNF-2B
FF196  For Upgrade, use FS1220 NOTE: May also replace 702143-C1 if clearance is less than 8 inches. If greater than 8 inches use FF5020 Overall Height: 5.90 (150) Largest OD: 3.72 (94) Thread Size: 1-14 UNS-2B	FF205  KOMATSU 6610728600 Overall Height: 9.72 (247) Overall OD: 5.00 (127) End 1 ID: 0.99 (25)	FF218  KOMATSU 6003118210 Uses service part: 151884S Gasket: 151884, 3307447 Overall Height: 4.11 (104) Overall OD: 2.93 (74) End 1 ID: 0.62 (16)
FF198  JOHN DEERE AR45098 Gasket: 255622 Overall Height: 6.21 (158) Largest OD: 3.73 (95) Thread Size: 1-14 UNS-2B	FF208  GMC 6436874 Gasket: 3300597, 3300598 Overall Height: 10.00 (254) Overall OD: 5.50 (140) End 1 ID: 2.50 (64)	FF219  GM 5651810 Overall Height: 2.03 (52) Overall OD: 0.69 (18) End 1 ID: 0.20 (5)
FF199  JOHN DEERE AT20541T Overall Height: 4.00 (102) Overall OD: 3.00 (76) End 1 ID: 0.73 (19)	FF209  THERMO-KING 113855 Overall Height: 8.72 (221) Largest OD: 3.71 (94) Thread Size: 7/8-14 UNF-2B	FF220  GM 5651809 Overall Height: 1.03 (26) Overall OD: 0.70 (18) End 1 ID: 0.20 (5)

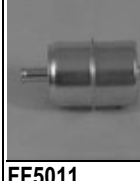
E. PRODUCT GUIDE

FF221  CASE 478037C1, KOMATSU 6003116200, DONALDSON P550673 Uses service part: 151884S Gasket: 151884, 3302574 Overall Height: 2.20 (56) Overall OD: 2.93 (74) End 1 ID: 0.61 (15)	FF231  DAF 247139, KHD(KLOCKNER-HUMBOLDT-DEUTZ) 1164620, IVECO 1164620 Overall Height: 5.59 (142) Largest OD: 3.68 (94) Thread Size: M16 X 1.5-6H INT	FF246  DONALDSON P550674 Filter used with 3307454S Bulk Fuel Tank Filter Gasket: 326882 Overall Height: 5.23 (133) End 1 OD: 2.96 (75) End 2 OD: 2.90 (74) End 1 ID: 0.86 (22) Thread Size: 1 1/8-12 UNF-2A
FF222  MACK 483GB431 For Upgrade, use FF5348 Overall Height: 10.39 (264) Largest OD: 4.26 (108) Thread Size: 1 1/16-16 UN-2B	FF232  ISUZU 1132400440, FIAT HITACHI 76590663 Overall Height: 7.55 (192) Largest OD: 3.72 (94) Thread Size: 1-14 UNS-2B	FF248  FIAT-ALLIS 74048796 Gasket: 105209 (2), 251379 Overall Height: 4.03 (102) Overall OD: 3.00 (76) End 1 ID: 0.77 (20)
FF223  CASE A39867 Gasket: 335255 Overall Height: 4.94 (125) Largest OD: 3.69 (94) Thread Size: 15/16-16 UN-2B	FF234  CATERPILLAR 9M2341 Uses service part: 3838230S Cleanable element Overall Height: 3.00 (76) Overall OD: 2.25 (57) End 1 ID: 0.39 (10)	FF220  CUMMINS 4088272, CUMMINS 4920586 "Pressure-side" fuel filter for the new engine platform. Supports Enforcer Engine Program for Cummins. Gasket: 3898536 (1) Overall Height: 8.98 (228) Largest OD: 3.82 (97) Thread Size: M72 X 2-7H INT
FF224  CASE A39868 Overall Height: 5.00 (127) Largest OD: 3.70 (94) Thread Size: 13/16-18 UNS-2B	FF235  FORD E0HT9155C2A, KOMATSU 304346, VOLVO 27852 Is a short version of FF5207 Overall Height: 4.16 (106) Largest OD: 3.70 (94) Thread Size: 1-12 UNF-2B	FF2203  CUMMINS 4010476 Gasket: 333849 (1) Overall Height: 5.78 (147) Largest OD: 3.70 (94) Thread Size: 1-14 UNS-2B
FF225  KOMATSU 6110736130 Overall Height: 5.56 (141) Overall OD: 3.48 (88) End 1 ID: 0.57 (14)	FF236  GMC 25010487 Height: 2.38 (60) Length: 4.00 (102) Width: 2.62 (67)	FF4008  PERKINS 26560088 Gasket: GP4400, GP4414(2) Overall Height: 5.28 (134) End 1 OD: 3.47 (88) End 2 OD: 3.31 (84) End 1 ID: 0.74 (19) End 2 ID: 1.50 (38)
FF226  PURFLUX CS153 Overall Height: 5.59 (142) Largest OD: 3.68 (94) Thread Size: 3/4-16 UNF-2B	FF239  CHRYSLER 3879782 w/ diverter tube Overall Height: 3.90 (99) Inlet Connection: .315 Outlet Connection: .315 Largest element OD: 1.93 (49)	FF4010  GARDNER GFF310, ROLLS ROYCE OD3928 Gasket: GP4408, GP4409 Overall Height: 5.43 (138) Overall OD: 2.80 (71) End 1 ID: 1.32 (34)
FF228  ALLIS-CHALMERS 61662756, RENAULT V.I. 7701006012 Gasket: 3321399 (2) Overall Height: 4.08 (104) End 1 OD: 3.78 (96) End 2 OD: 3.66 (93) End 1 ID: 1.69 (43) End 2 ID: 1.26 (32)	FF244  GMC 6438089 Gasket: 317844 Overall Height: 2.80 (71) Overall OD: 2.42 (62) End 1 ID: 1.09 (28)	FF4011  GARDNER GFF2A2 Gasket: GP4420 Overall Height: 3.54 (90) Overall OD: 2.26 (58) End 1 ID: 0.39 (10)
FF230  MANN & HUMMEL P715 Gasket: 3310850, 3323007 ¹⁰ , 3323009 ¹⁰ Overall Height: 2.44 (62) Overall OD: 2.76 (70) End 1 ID: 0.50 (13)	FF245  CASE A21141 Gasket: 250938 Overall Height: 4.64 (118) Overall OD: 2.39 (61) End 1 ID: 1.09 (28)	FF4012  COOPERS 4963 Petter JE64/6B Gasket: GP4401, GP4405, GP4406 Overall Height: 1.50 (38) Overall OD: 2.19 (56) End 1 ID: 0.91 (23) End 2 ID: 0.27 (7)





















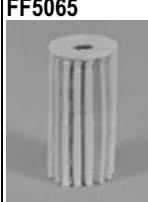

E. PRODUCT GUIDE

FF4033  MERCEDES-BENZ 4773115, KHD(KLOCKNER- HUMBOLDT-DEUTZ) R1H4115 Gasket: 3323008 ¹⁰ , 3324564 ¹⁰ Overall Height: 5.71 (145) Overall OD: 3.28 (83) End 1 ID: 0.54 (14)	FF4134  Benford, Lister, Ruston Overall Height: 3.48 (89) Overall OD: 2.19 (56) End 1 ID: 0.91 (23) End 2 ID: 0.27 (7)	FF5013  Farm fuel tanks. Service pumps w/ draincock. Diesel fuel only. Overall Height: 7.70 (196) Largest OD: 3.73 (95) Thread Size: 1-12 UNF-2B
FF4036  ROLLS ROYCE OE42873 Gasket: 3300674 Overall Height: 7.56 (192) Largest OD: 3.68 (94) Standpipe: YES Thread Size: M24 X 1.5-6H INT	FF4136  GMC 25012015, AC TP1062, MANN & HUMMEL W7231 Overall Height: 4.63 (118) Largest OD: 3.05 (77) Thread Size: 3/4-16 UNF-2B	FF5014  FORD D7TZ9155B Overall Height: 2.28 (58) Inlet Connection: .315 Outlet Connection: 1/8-27 NPTF DRYSEAL Largest element OD: 1.30 (33)
FF4052  MASSEY-FERGUSON 1896287M91 Pleated Paper Version. Rolled Paper Version is FF4052A Gasket: GP4422, GP4423, GP4424 Overall Height: 4.45 (113) End 1 OD: 3.47 (88) End 2 OD: 3.31 (84) End 1 ID: 0.74 (19) End 2 ID: 1.50 (38)	FF4141  BOSCH 1457431158, KHD(KLOCKNER- HUMBOLDT-DEUTZ) W05H4115 Gasket: 3323007 ¹⁰ , 3323009 ¹⁰ , 3323010 ¹⁰ Overall Height: 4.53 (115) Overall OD: 2.55 (65) End 1 ID: 0.54 (14)	FF5015  Buick, Oldsmobile In-Line Fuel Overall Height: 3.90 (99) Inlet Connection: .315 HOSE Outlet Connection: .315 HOSE Largest element OD: 1.97 (50)
FF4052A  MASSEY-FERGUSON 1896287M91 Rolled Paper Version. Pleated Paper Version is FF4052 Gasket: GP4244, GP4422, GP4423 Overall Height: 4.45 (113) End 1 OD: 3.48 (89) End 2 OD: 3.31 (84) End 1 ID: 0.75 (19) End 2 ID: 0.63 (16)	FF5000  CASE A77220 Overall Height: 7.91 (201) Largest OD: 3.70 (94) Thread Size: 15/16-16 UN-2B	FF5017  THERMO-KING 113692 Overall Height: 6.91 (176) Largest OD: 3.73 (95) Thread Size: 1-14 UNS-2B
FF4070  MANN & HUMMEL WK9624, DAF 247138 For Stratapore version, use FF5313 Overall Height: 8.29 (211) Largest OD: 3.70 (94) Thread Size: M16 X 1.5-6H INT	FF5002  WHITE 163956AS White 163956-AS, Roosmaster 16637 Gasket: 3313293, 3313294, 3313295 Overall Height: 3.81 (97) Overall OD: 3.33 (85) End 1 ID: 0.75 (19)	FF5018  VOLVO 243004, KHD(KLOCKNER- HUMBOLDT-DEUTZ) Q1H4117 Filter used with 3311505S For Stratapore version, use FF5461 For Upgrade, use FS1221 Product is not available in all regions of the world. Overall Height: 4.92 (125) Largest OD: 3.05 (78) Standpipe: YES Thread Size: M16 X 1.5-6H INT
FF4080  FIAT-ALLIS 70757242 Overall Height: 9.48 (241) End 1 OD: 2.98 (76) End 2 OD: 2.96 (75) End 1 ID: 1.04 (26)	FF5006  FORD D7TA9155AB Overall Height: 3.86 (98) Inlet Connection: 0.375 Outlet Connection: 0.375 Largest element OD: 1.94 (49)	FF5019  CASE 672603C2 Secondary Fuel Overall Height: 8.11 (206) Largest OD: 4.26 (108) Thread Size: 7/8-14 UNF-2B
FF4119  ALCO LOCOMOTIVE 2321946 Overall Height: 12.13 (308) End 1 OD: 4.98 (126) End 2 OD: 4.97 (126) End 1 ID: 0.68 (17)	FF5011  Farm fuel tanks. Service pumps w/drain cock. Diesel fuel only. Overall Height: 7.70 (196) Largest OD: 3.73 (95) Thread Size: 1-12 UNF-2B	FF5020  CASE 625627C1 For Upgrade, use FS1225 Primary Fuel Overall Height: 8.06 (205) Largest OD: 3.72 (94) Thread Size: 1-14 UNS-2B
	FF5012  Bulk Fuel Tank Filter Diesel Fuel Only Overall Height: 5.42 (138) Largest OD: 3.69 (94) Thread Size: 1-12 UNF-2B	FF5021  VOLVO 27853 For Upgrade, use FF5335 Overall Height: 4.31 (109) Largest OD: 3.70 (94) Thread Size: 13/16-12 UNS-2B

E. PRODUCT GUIDE

<p>FF5022 MOTORCRAFT FG44A</p>  <p>Overall Height: 2.94 (75) Inlet Connection: .315 Outlet Connection: .315 Largest element OD: 0.93 (24)</p>	<p>FF5033 GMC 25011214 Product is not available in all regions of the world.</p>  <p>Overall Height: 4.57 (116) Largest OD: 3.05 (77) Thread Size: M16 x 1.5-6H INT</p>	<p>FF5043 IVECO 1901607 Fiat 8830319, 8827122, 8827279</p>  <p>Overall Height: 4.51 (115) Largest OD: 4.25 (108) Thread Size: 3/4-16 UNF-2B</p>
<p>FF5026 AC GF481, GMC 25055052</p>  <p>Overall Height: 4.21 (107) Inlet Connection: M16x1.5-6H Outlet Connection: M16x1.5-6H Largest element OD: 2.15 (55)</p>	<p>FF5034 GMC 25011285</p>  <p>Overall Height: 6.86 (174) Largest OD: 3.69 (94) Thread Size: 1-12 UNF-2B</p>	<p>FF5044 LISTER PETTER 330573</p>  <p>Overall Height: 2.97 (76) End 1 OD: 1.20 (31) End 2 OD: 1.18 (30) End 1 ID: 0.19 (5)</p>
<p>FF5027 FORD E0ZZ9155A</p>  <p>Overall Height: 1.92 (49) Inlet Connection: 1/8-27 NPTF-2A Outlet Connection: 1/2-20 UNF-2B Largest element OD: 1.30 (33)</p>	<p>FF5035 FORD E2PJ9155AA, CASE 1804459C1 For separator version, use FS1231 Is a short version of FF5078</p>  <p>Overall Height: 4.72 (120) Largest OD: 4.26 (108) Thread Size: 7/8-14 UNF-2B</p>	<p>FF5045 JOHN DEERE AR86745</p>  <p>Height: 3.30 (84) Length: 5.15 (131) Width: 3.71 (94)</p>
<p>FF5028 ISUZU 5878100500</p>  <p>Gasket: 334856, 334857, 334858, 334859 Overall Height: 3.30 (84) Overall OD: 2.81 (71) End 1 ID: 0.58 (15)</p>	<p>FF5036 GMC 25011024 Uses service part: 3312091S</p>  <p>Overall Height: 8.97 (228) Largest OD: 4.74 (120) Thread Size: 1 1/4-12 UNS-2B</p>	<p>FF5046 BOSCH 1457434099, CASE 3218794R91 Secondary Fuel used with FF5047</p>  <p>Overall Height: 4.47 (114) Largest OD: 3.35 (85) Thread Size: M16 X 1.5-6H</p>
<p>FF5029 ISUZU 9885111911</p>  <p>Gasket: 334856, 334857, 334859, 334866 (2) Overall Height: 4.17 (106) Overall OD: 2.80 (71) End 1 ID: 0.62 (16)</p>	<p>FF5037 GMC 25011026, HITACHI 12978047 Uses service part: 3312092S</p>  <p>Overall Height: 8.97 (228) Largest OD: 4.74 (120) Thread Size: 1 1/16-16 UN-2B</p>	<p>FF5047 CASE 3218793R91 Primary Fuel used with FF5046</p>  <p>Overall Height: 3.76 (96) Largest OD: 3.47 (88) Thread Size: M16 X 1.5-6H INT</p>
<p>FF5030 ISUZU H132401, INGERSOLL-RAND 85448454 Product is not available in all regions of the world.</p>  <p>Overall Height: 3.49 (89) Largest OD: 3.05 (77) Thread Size: 3/4-16 UNF-2B</p>	<p>FF5039 IVECO 1901605</p>  <p>Overall Height: 7.31 (186) Largest OD: 4.25 (108) Thread Size: 3/4-16 UNF-2B</p>	<p>FF5048 PURFLUX CS156, RENAULT V.I. 5000240934</p>  <p>Overall Height: 4.06 (103) End 1 OD: 3.48 (89) End 2 OD: 3.33 (85) End 1 ID: 0.91 (23)</p>
<p>FF5031 ONAN 122B326</p>  <p>Overall Height: 4.80 (122) Largest OD: 3.44 (87) Thread Size: 3/8-24 UN-2B</p>	<p>FF5040 BOSCH 1457434051 Is a longer version of FF5422</p>  <p>Overall Height: 3.40 (86) Largest OD: 2.94 (75) Thread Size: M16x1.5-6H</p>	<p>FF5049 RENAULT V.I. 7701016560</p>  <p>Overall Height: 2.80 (71) End 1 OD: 3.48 (89) End 2 OD: 3.33 (85) End 1 ID: 0.91 (23)</p>
<p>FF5032 ONAN 122B325</p>  <p>Overall Height: 4.80 (122) Largest OD: 3.44 (87) Thread Size: 7/16-20 UNF-2B</p>	<p>FF5041 IVECO 3363287</p>  <p>Overall Height: 4.90 (125) Largest OD: 3.15 (80) Standpipe: YES Thread Size: M14 X 1.5-6H INT</p>	<p>FF5050 M.A.N. A0854975700</p>  <p>Overall Height: 1.97 (50) Overall OD: 2.56 (65) End 1 ID: 0.55 (14)</p>























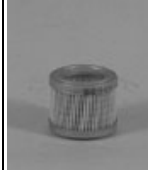

E. PRODUCT GUIDE

FF5051  GMC 14069588 Height: 2.43 (62) Length: 4.61 (117) Width: 2.83 (72)	FF5059  FRAM PS3808, PUROLATOR GP23, DONALDSON P550677, FORD 35604941 Overall Height: 3.75 (95) Largest OD: 3.80 (97) Thread Size: 11/16-16 UN-2B	FF5069  NISSAN 1644499128 Gasket: 3830642, 3830643, 3830644, 3830677 Overall Height: 5.28 (134) Overall OD: 3.60 (91) End 1 ID: 0.79 (20)
FF5052  CUMMINS 3903640, VOLVO 36845, CUMMINS 3931063, CUMMINS 3931065 Filter used with 3311505S For Upgrade, use FS1251 Product is not available in all regions of the world. Gasket: 3311919 Overall Height: 4.59 (117) Largest OD: 3.03 (77) Standpipe: YES Thread Size: M16 X 1.5-6H INT	FF5062  FORD D7ZE9155AB Overall Height: 1.25 (32) End 1 OD: 0.63 (16) End 2 OD: 0.69 (17) End 1 ID: 0.41 (10)	FF5070  NISSAN 16444Z9000 Gasket: 3830675, 3830676 Overall Height: 3.54 (90) Overall OD: 2.83 (72) End 1 ID: 0.75 (19)
FF5053  MERCEDES-BENZ 3524700092 Gasket: 3326647 Overall Height: 4.53 (115) Overall OD: 2.55 (65) End 1 ID: 0.54 (14)	FF5063  FIAT-ALLIS 1909124, TECNOCAR N11950SC For replacement element use FF5065 Overall Height: 8.86 (225) Overall OD: 3.58 (91) End 1 ID: 1.02 (26)	FF5071  NISSAN 1644499028 Gasket: 3830673, 3830674 Overall Height: 5.51 (140) Overall OD: 4.41 (112) End 1 ID: 0.72 (18)
FF5054  MERCEDES-BENZ 4220900051 Uses service part: 3323008S Gasket: 3323008 Overall Height: 5.71 (145) Overall OD: 3.28 (83) End 1 ID: 0.54 (14)	FF5064  FIAT-ALLIS 1909107, FIAT-ALLIS 4964323 For replacement element use FF5065 Gasket: 3321372 Overall Height: 7.44 (189) Overall OD: 3.58 (91) End 1 ID: 1.02 (26) End 2 ID: 0.51 (13)	FF5072  MITSUBISHI ME034678 Gasket: 3830639, 3830672 Overall Height: 4.33 (110) Overall OD: 3.62 (92) End 1 ID: 0.67 (17)
FF5055  CUMMINS 3337244 Deutz 1160035 Gasket: 3901134, 3901135 Overall Height: 6.69 (170) Overall OD: 3.94 (100) End 1 ID: 0.76 (19)	FF5065  FIAT-ALLIS 1909126, TECNOCAR N11950RS For complete filter use FF5063 or FF5064 depending on application Overall Height: 6.89 (175) Overall OD: 3.35 (85) End 1 ID: 1.61 (41)	FF5074  RENAULT V.I. 5000814227 For Stratapore version, use FF5442 Product is not available in all regions of the world. Overall Height: 4.92 (125) Largest OD: 3.05 (78) Thread Size: M16 X 1.5-6H INT
FF5056  CARRIER 3050301 Overall Height: 6.45 (164) Largest OD: 3.69 (94) Thread Size: 13/16-18 UNS-2B	FF5066  FRAM G1 In-Line Fuel Overall Height: 4.05 (103) Inlet Connection: 0.25 Outlet Connection: 0.25 Largest element OD: 1.91 (48)	FF5076  KOMATSU 6003119120 Overall Height: 7.55 (192) Largest OD: 3.72 (94) Thread Size: 1-14 UNS-2B
FF5057  FIAT-ALLIS 209930450 Overall Height: 2.60 (66) Overall OD: 2.17 (55) End 1 ID: 0.39 (10)	FF5067  CASE 674293C1 Overall Height: 8.82 (224) Largest OD: 3.69 (94) Thread Size: 7/8-14 UNF-2B	FF5077  CUMMINS 3318919 Overall Height: 3.62 (92) Inlet Connection: 5/8-24 UNEF-2A Outlet Connection: 5/8-24 UNEF-2A Largest element OD: 1.91 (48)
FF5058  KOMATSU 6003118220 Is a longer version of FF5304 Overall Height: 5.91 (150) Largest OD: 3.05 (77) Thread Size: 3/4-16 UNF-2B	FF5068  HINO 234011060 Gasket: 3830668 Overall Height: 2.36 (60) Overall OD: 2.44 (62) End 1 ID: 0.63 (16)	FF5078  INTERNATIONAL TRUCKS 1809789C1 For separator version, use FS1231 Is a longer version of FF5035, FF5269 Overall Height: 8.11 (206) Largest OD: 4.26 (108) Thread Size: 7/8-14 UNF-2B

























E. PRODUCT GUIDE

FF5079  CUMMINS 3826094, OMNIQUIP PARTS WORLDWIDE 8274022 Overall Height: 3.89 (99) Inlet Connection: .433 Outlet Connection: .433 Largest element OD: 1.91 (48)	FF5089  MITSUBISHI ME035829 Overall Height: 4.31 (109) Largest OD: 3.73 (95) Thread Size: M20 X 1.5-6H INT	FF5097  FORD E3FZ9155C Includes 2 clamps Overall Height: 5.45 (138) Inlet Connection: .311 HOSE Outlet Connection: .311 HOSE Largest element OD: 3.22 (82)
FF5081  KOMATSU 6003116221 Overall Height: 3.50 (89) Largest OD: 3.05 (77) Thread Size: 3/4-16 UNF-2B	FF5090  NISSAN 1644490127 Gasket: 3830642, 3830643, 3830644 Overall Height: 5.65 (144) Overall OD: 3.53 (90) End 1 ID: 0.57 (14)	FF5098  CASE D139225 Overall Height: 3.90 (99) Inlet Connection: .374 Outlet Connection: .374 Largest element OD: 1.91 (49)
FF5082  HITACHI 4020429 Gasket: 3831242 (2), 3831243, 3831245 Overall Height: 4.04 (103) Overall OD: 2.79 (71) End 1 ID: 0.59 (15)	FF5091  FORD E6HZ9365B Overall Height: 2.56 (65) Largest OD: 3.05 (77) Thread Size: M16 X 1.5-6H INT	FF5099  LISTER PETTER 20332470 Gasket: 3322016, 3322017, 3322018 Overall Height: 2.48 (63) Overall OD: 2.19 (56) End 1 ID: 0.91 (23) End 2 ID: 0.27 (7)
FF5084  ISUZU 1878100270 Gasket: 3830644, 3830669, 3830670 Overall Height: 5.65 (144) Overall OD: 3.53 (90) End 1 ID: 0.57 (14)	FF5092  Toyota Forklifts Overall Height: 3.08 (78) Largest OD: 3.05 (77) Thread Size: 3/4-16 UNF-2B	FF5100  MERCEDES-BENZ 3444777215 Overall Height: 4.41 (112) Overall OD: 2.36 (60) End 1 ID: 0.53 (13)
FF5085  ISUZU 1878102070 Gasket: 3831037 (2), 3831038(2), 3831235 Overall Height: 6.53 (166) End 1 OD: 3.70 (94) End 2 OD: 3.97 (101) End 1 ID: 0.61 (15)	FF5093  MITSUBISHI 3196204010 Gasket: 3830639, 3830642, 3830643, 3830644 Overall Height: 5.59 (142) Overall OD: 3.58 (91) End 1 ID: 0.57 (14)	FF5102  KUBOTA 1560543060 Overall Height: 4.13 (105) Overall OD: 2.95 (75) End 1 ID: 0.61 (16)
FF5086  MITSUBISHI 3006265011 Gasket: 3830639, 3830642, 3830643, 3830644 Overall Height: 5.55 (141) Largest OD: 3.58 (91) End 1 ID: .53 (13)	FF5094  FIAT-ALLIS 74788503 Overall Height: 7.14 (181) Largest OD: 4.26 (108) Thread Size: 3/4-16 UNF-2B	FF5103  KUBOTA 1552143160, FIAT HITACHI 76591700 Overall Height: 3.50 (89) Overall OD: 1.97 (50) End 1 ID: 0.80 (20)
FF5087  MITSUBISHI ME006066 Overall Height: 3.31 (84) Largest OD: 3.69 (94) Thread Size: M20 X 1.5-6H INT	FF5095  FORD E6HZ9365A Product is not available in all regions of the world. Gasket: 3311919 Overall Height: 4.10 (104) Largest OD: 3.06 (78) Thread Size: M16 x 1.5-6H INT	FF5104  KUBOTA 1532146563 Overall Height: 3.41 (87) Overall OD: 1.15 (29) End 1 ID: 0.52 (13)
FF5088  MITSUBISHI ME016823 Overall Height: 3.95 (100) Largest OD: 3.73 (95) Thread Size: M20X1.5-6H U	FF5096  FIAT-ALLIS 79924321 Overall Height: 6.05 (154) Largest OD: 3.69 (94) Thread Size: 3/4-16 UNF-2B	FF5105  MANN & HUMMEL P10181 Uses service part: 3320223S, 3320224S Gasket: 3320223 ¹⁰ , 3320224 ¹⁰ Overall Height: 6.73 (171) Overall OD: 3.94 (100) End 1 ID: 0.76 (19)



















E. PRODUCT GUIDE

FF5108  HITACHI 4178800, HITACHI 4206080 Overall Height: 4.82 (123) Largest OD: 3.82 (97) Thread Size: 3/4-16 UNF-2B	FF5118  Belarus Tractor Applications Overall Height: 5.91 (150) Overall OD: 3.01 (76) End 1 ID: 1.04 (26)	FF5134  FORD E3TZ9155C, MOTORCRAFT FG853 Ford E3TZ-9155-BA Overall Height: 1.93 (49) Housing OD: 1.00 (25) Inlet Connection: 7/8-20 UNEF-2A Outlet Connection: 1/2-20 UNF-2B
FF5109  FIAT-ALLIS 74321716, NEW HOLLAND 74321716 Overall Height: 7.75 (197) Largest OD: 3.73 (95) Thread Size: 15/16-16 UN-2B	FF5119  NISSAN 1644497001 Overall Height: 8.35 (212) Overall OD: 4.34 (110) End 1 ID: 0.60 (15)	FF5135  V.A.G. (VOLKSWAGEN, AUDI) 68127177 For Stratapore version, use FS19599 Product is not available in all regions of the world. Overall Height: 6.14 (156) Largest OD: 3.03 (77) Thread Size: M16 X 1.5-6H INT
FF5110  MANN & HUMMEL H12178 Overall Height: 13.19 (335) Overall OD: 4.57 (116) End 1 ID: 2.17 (55)	FF5121  HINO 234011080 Gasket: 3834591, 3834592, 3834593, 3834597 Overall Height: 4.27 (108) Overall OD: 4.09 (104) End 1 ID: 0.59 (15)	FF5136  HINO 235011010 Overall Height: 5.77 (147) Largest OD: 3.72 (94) Thread Size: 1-14 UNS-2B
FF5112  MERCEDES-BENZ 10920501, MULTIPART VFF1006 Overall Height: 3.49 (89) Largest OD: 3.05 (77) Thread Size: M14 X 1.5-6H INT	FF5122  MITSUBISHI ME971550 In Europe use gaskets 3624918, 3624919 and washer 3624915 Gasket: 3834601, 3834608 Overall Height: 5.62 (143) Overall OD: 3.58 (91) End 1 ID: 0.60 (15)	FF5137  HINO 234011400, HINO 234011402 Overall Height: 5.45 (138) Largest OD: 3.69 (94) Thread Size: 1-14 UNS-2B
FF5113  KHD(KLOCKNER-HUMBOLDT-DEUTZ) 1174691 Product is not available in all regions of the world. Gasket: 330818 Overall Height: 3.19 (81) Largest OD: 3.05 (78) Thread Size: M16 X 1.5-6H INT	FF5126  ZENOR/ SDLM 270 Overall Height: 4.65 (118) Overall OD: 3.15 (80) End 1 ID: 1.42 (36) End 2 ID: 0.43 (11)	FF5138  HINO 234011410 Overall Height: 3.98 (101) Largest OD: 3.32 (84) Thread Size: 3/4-16 UNF-2B
FF5114  KOMATSU 6003117441, FIAT HITACHI 76595561, TOYOTA 2330356031, NISSAN 16403Z7000, GMC 94414796, CUMMINS C6003117460, CUMMINS C6003112110, KOMATSU 6003112110 Overall Height: 3.22 (82) Largest OD: 3.31 (84) Thread Size: 3/4-16 UNF-2B	FF5131  MITSUBISHI MM408992 Overall Height: 1.43 (36) Overall OD: 1.61 (41) End 1 ID: 0.98 (25)	FF5139  PINGUELY 2427002820 Overall Height: 6.14 (156) Largest OD: 3.03 (77) Thread Size: M16 X 1.5-6H INT
FF5116  NISSAN 16405V5710 Overall Height: 5.36 (136) Largest OD: 3.13 (80) Thread Size: 3/4-16 UNF-2B	FF5132  CATERPILLAR 8N3080 Overall Height: 12.19 (310) Largest OD: 5.41 (137) Thread Size: 1 3/8-16 UNS-2B	FF5141  ISUZU X13240024 Gasket: 3836008 Overall Height: 5.01 (127) Largest OD: 3.72 (94) Thread Size: 3/4-16 UNF-2B
FF5117  LIEBHERR 7008776 Overall Height: 5.65 (144) Largest OD: 3.35 (85) Thread Size: M16 X 1.5-6H INT	FF5133  AC GF483 Overall Height: 5.00 (127) Inlet Connection: 16 X 1.5 Outlet Connection: .375 HOSE Largest element OD: 2.20 (56)	FF5145  DAVCO 100496 Overall Height: 3.68 (93) Largest OD: 3.69 (94) Thread Size: 7/8-14 UNS-2B

E. PRODUCT GUIDE

FF5146  CASE 1816246C1 Overall Height: 5.33 (135) Largest OD: 4.26 (108) Thread Size: 7/8-14 UNF-2B	FF5159  TOYOTA 2330364010 Overall Height: 5.43 (138) Largest OD: 3.70 (94) Thread Size: 3/4 - 16 UNF-2B	FF5170  YALE & TOWNE 900325802 Overall Height: 1.88 (48) Overall OD: 1.38 (35) End 1 ID: 0.49 (12)
FF5147  CASE 1959599C1 Overall Height: 2.87 (73) Largest OD: 3.31 (84) Thread Size: M20 X 1.5-6H INT	FF5160  MITSUBISHI MB220900, ISUZU 5132400320 Overall Height: 5.45 (138) Largest OD: 3.88 (99) Thread Size: M20X1.5	FF5171  CASE 1967094C1 Product is not available in all regions of the world. Overall Height: 6.34 (161) Largest OD: 3.05 (77) Thread Size: M16 X 1.5-6H INT
FF5148  DAVCO 320330 Overall Height: 4.59 (117) Largest OD: 3.69 (94) Thread Size: 1-14 UNS-2B	FF5161  MITSUBISHI ME035394 Overall Height: 6.80 (173) Largest OD: 3.91 (99) Thread Size: 1-14 UNS-2B	FF5172  NISSAN 16403Z9000 Overall Height: 4.18 (106) Largest OD: 3.13 (80) Thread Size: 3/4-16 UNS-2B
FF5151  FORD FOHN9176AA For separator version, use FS1281 Ford Brazilian Overall Height: 6.91 (176) Largest OD: 3.73 (95) Thread Size: 1-14 UNS-2B	FF5163  TOYOTA 16405T9005 Gasket: 330818 Overall Height: 4.40 (112) Largest OD: 3.05 (77) Thread Size: 3/4-16 UNF-2B	FF5173  TOYOTA 2330030012 Overall Height: 4.45 (113) Inlet Connection: 1/2 X 18 THREAD Outlet Connection: 1/2 X 18 THREAD Largest element OD: 3.96 (100)
FF5152  NISSAN 16404K4046 Overall Height: 1.71 (43) Overall OD: 1.58 (40) End 1 ID: 0.27 (7)	FF5165  YALE & TOWNE 900907811 Overall Height: 5.07 (129) Largest OD: 3.85 (98) Thread Size: M20 X 1.5 INT	FF5174  TOYOTA 2330034100 Overall Height: 2.32 (59) Inlet Connection: 0.276 Outlet Connection: 0.276 Largest element OD: 1.89 (48)
FF5156  BOSCH 1457434061 Overall Height: 6.14 (156) Largest OD: 3.03 (77) Thread Size: M16 X 1.5-6H INT	FF5166  MITSUBISHI 9316503200 Overall Height: 2.50 (64) Inlet Connection: 1/4 NPT Outlet Connection: 2 1/4 NPT Largest element OD: 1.62 (41)	FF5175  MOPAR 4443461 Overall Height: 3.64 (92) Inlet Connection: 0.31 Outlet Connection: 0.31 Largest element OD: 2.22 (56)
FF5157  NISSAN FL40399008 Overall Height: 6.95 (177) Largest OD: 3.68 (93) Thread Size: 1-14 UNS-2B	FF5167  RENAULT V.I. 5000686590, RENAULT V.I. 5000686589 High performance version of FF5074 Overall Height: 4.92 (125) Largest OD: 3.05 (78) Thread Size: M16 X 1.5-6H INT	FF5176  NISSAN 16400N9600 Overall Height: 4.94 (125) Inlet Connection: 0.31 Outlet Connection: 0.33 Largest element OD: 3.12 (79)
FF5158  NISSAN FL403Z9005 Overall Height: 4.49 (114) Largest OD: 3.32 (84) Thread Size: 3/4-16 UNF-2B	FF5169  TOWMOTOR 6194 Overall Height: 3.18 (81) Overall OD: 1.75 (44)	FF5177  TOYOTA 2330065010 Overall Height: 4.07 (103) Inlet Connection: M14x1.5-6H Outlet Connection: M14x1.5-6H Largest element OD: 2.89 (73)

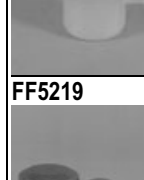











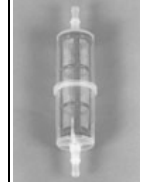

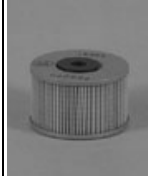

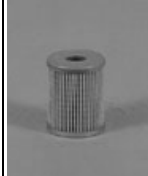



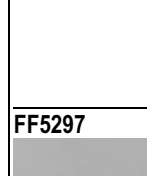

E. PRODUCT GUIDE

<p>FF5178 CHRYSLER 4279987</p>  <p>Overall Height: 4.75 (121) Inlet Connection: 0.375 Outlet Connection: 0.375 Largest element OD: 2.16 (55)</p>	<p>FF5189 MOTORCRAFT FG855</p>  <p>Overall Height: 1.50 (38) Overall OD: 2.77 (70) End 1 ID: 0.50 (13)</p>	<p>FF5200 CHRYSLER 4279898</p>  <p>Overall Height: 4.75 (121) Inlet Connection: 0.38 Outlet Connection: 0.38 Largest element OD: 2.16 (55)</p>
<p>FF5179 CHRYSLER MB052676</p>  <p>Overall Height: 3.60 (91) Inlet Connection: 0.31 Outlet Connection: 0.31 Largest element OD: 2.10 (53)</p>	<p>FF5190 Various auto and light truck applications</p>  <p>Overall Height: 4.82 (122) Inlet Connection: 0.31 Outlet Connection: 0.31 Largest element OD: 2.44 (62)</p>	<p>FF5206 AC TP916D, GMC 25014342 Uses service part: 3833200S For Upgrade, use FF5333</p>  <p>Overall Height: 6.89 (175) Largest OD: 3.67 (93) Thread Size: 13/16-12 UNS-2B</p>
<p>FF5181 MAZDA F50813470</p>  <p>Overall Height: 2.34 (59) Inlet Connection: 0.31 Outlet Connection: 0.31 Largest element OD: 2.10 (53)</p>	<p>FF5192 TOYOTA 2330025020</p>  <p>Overall Height: 2.31 (59) Inlet Connection: 0.27 Outlet Connection: 0.27 Largest element OD: 2.24 (57)</p>	<p>FF5207 AC TP915D, GMC 25014274, DETROIT DIESEL 25014274 Is a longer version of FF235 Uses service part: 3833199S For Upgrade, use FS19513</p>  <p>Overall Height: 8.10 (206) Largest OD: 3.72 (94) Thread Size: 1-12 UNS-2B</p>
<p>FF5182 TOYOTA 2303079025</p>  <p>Overall Height: 4.53 (115) Inlet Connection: M12x1.25-6H Outlet Connection: M14x1.5-6H Largest element OD: 2.75 (70)</p>	<p>FF5194 GMC 94847597</p>  <p>Overall Height: 4.61 (117) Inlet Connection: M14x1.5-6H Outlet Connection: M12x1.25-6H Largest element OD: 2.80 (71)</p>	<p>FF5212 CASE 1820479C1</p>  <p>Overall Height: 5.91 (150) Largest OD: 3.05 (77) Thread Size: 7/8-14 UNF-2B</p>
<p>FF5183 HONDA 16900SE0003</p>  <p>Overall Height: 2.60 (66) Inlet Connection: 0.31 Outlet Connection: 0.31 Largest element OD: 1.97 (50)</p>	<p>FF5196 HONDA 16900SA5003, HONDA 16900SA5004</p>  <p>Overall Height: 2.64 (67) Inlet Connection: 0.35 Outlet Connection: 0.35 Largest element OD: 2.12 (54)</p>	<p>FF5213 SUBARU 742023000</p>  <p>Overall Height: 2.39 (61) Inlet Connection: 0.31 Outlet Connection: 0.31 Largest element OD: 2.18 (55)</p>
<p>FF5184 AC GF562</p>  <p>Overall Height: 17.24 (438) Inlet Connection: 0.37 Outlet Connection: 0.37 Largest element OD: 2.08 (53)</p>	<p>FF5197 ZETOR 950800</p>  <p>Gasket: 3322967 Overall Height: 5.20 (132) Overall OD: 2.91 (74) End 1 ID: 0.81 (21)</p>	<p>FF5217 MAZDA JE1520490A</p>  <p>Overall Height: 5.43 (138) Inlet Connection: 1.2283 HOSE Outlet Connection: 2.2283 HOSE Largest element OD: 2.36 (60)</p>
<p>FF5185 VW 811133511A</p>  <p>Overall Height: 6.08 (154) Inlet Connection: M14x1.5-6H Outlet Connection: M12x1.5-6H Largest element OD: 3.41 (87)</p>	<p>FF5198 CAV (LUCAS-CAV) 7111996</p>  <p>Overall Height: 6.16 (157) End 1 OD: 3.50 (89) End 2 OD: 3.33 (85) End 1 ID: 0.63 (16)</p>	<p>FF5218 SUZUKI 154108000</p>  <p>Overall Height: 3.76 (96) Inlet Connection: 0.3125 HOSE Outlet Connection: 0.3125 HOSE Largest element OD: 2.24 (57)</p>
<p>FF5186 BMW 13321270038</p>  <p>Overall Height: 6.20 (157) Inlet Connection: 0.31 Outlet Connection: 0.31 Largest element OD: 3.19 (81)</p>	<p>FF5199 AC GF580, AC GF580K</p>  <p>Overall Height: 6.53 (166) Inlet Connection: 0.374 Outlet Connection: 0.374 Largest element OD: 2.16 (55)</p>	<p>FF5219 MAZDA S21323570</p>  <p>Overall Height: 3.97 (101) Largest OD: 3.76 (96) Standpipe: YES Thread Size: M20X1.5-6H U</p>
<p>FF5188 HONDA 16235PH1003</p>  <p>Overall Height: 3.31 (84) Inlet Connection: 0.31 Outlet Connection: 0.24 Largest element OD: 1.36 (35)</p>		























E. PRODUCT GUIDE

FF5220  TOYOTA 2330049155 Overall Height: 4.84 (123) Inlet Connection: M12 X 1.25-6H Outlet Connection: M12 X 1.25-6H Largest element OD: 2.75 (70)	FF5228  M.A.N. 81125030018 Same as FF147 w/ gasket 3323008S Gasket: 3323008 Overall Height: 5.71 (145) Overall OD: 3.28 (83) End 1 ID: 0.54 (14)	FF5244  FORD F0T29155B Overall Height: 6.73 (171) Inlet Connection: .311 HOSE Outlet Connection: .311 HOSE Largest element OD: 3.22 (82)
FF5221  CHRYSLER MB433774 Overall Height: 2.82 (72) Inlet Connection: .236 HOSE Outlet Connection: 2.264 HOSE Largest element OD: 2.95 (75)	FF5229  ISUZU 8944195320 Overall Height: 4.88 (124) Largest OD: 3.15 (80) Thread Size: M20 X 1.5-6H INT	FF5245  CATERPILLAR 1R0740 Downsize version of FF185 Overall Height: 7.09 (180) Largest OD: 3.34 (85) Thread Size: 1-14 UNS-2B
FF5222  SUBARU 742072040 Overall Height: 5.27 (134) Inlet Connection: .31 HOSE Outlet Connection: .31 HOSE Largest element OD: 3.13 (80)	FF5231  HITACHI 4206130 Overall Height: 3.62 (92) Largest OD: 3.68 (94) Thread Size: 3/4-16 UNF-1B	FF5251  CATERPILLAR 1R0725 Overall Height: 10.43 (265) Overall OD: 5.00 (127) End 1 ID: 2.19 (56)
FF5223  TOYOTA 2330035030 Overall Height: 4.92 (125) Inlet Connection: M12x1.5-6H Outlet Connection: M12x1.5-6H Largest element OD: 2.74 (70)	FF5234  MOTORCRAFT FG848 Overall Height: 2.55 (65) Overall OD: 2.79 (71) End 1 ID: 0.50 (13)	FF5253  KOMATSU 6003118292 Gasket: 333849 Overall Height: 6.10 (155) Largest OD: 3.73 (95) Thread Size: 1-14 UNS-2B
FF5224  MITSUBISHI MB504744 Overall Height: 5.12 (130) Inlet Connection: M12X1.25 Outlet Connection: M12X1.25 Largest element OD: 2.76 (70)	FF5235  V.A.G. (VOLKSWAGEN, AUDI) 133133511 Overall Height: 3.64 (92) Inlet Connection: 0.32 Outlet Connection: 0.48 Largest element OD: 2.11 (54)	FF5255  MAZDA 55923570 Overall Height: 3.94 (100) Largest OD: 3.72 (94) Thread Size: M20x1.5-6H
FF5225  CHRYSLER 4443452 Overall Height: 4.75 (121) Inlet Connection: 0.31 Outlet Connection: 0.31 Largest element OD: 2.17 (55)	FF5237  AMERICAN MOTORS 8983500998 Overall Height: 3.20 (81) Inlet Connection: 0.37 Outlet Connection: 0.3 Largest element OD: 1.95 (50)	FF5257  MITSUBISHI ME046010 Overall Height: 5.51 (140) Overall OD: 3.62 (92) End 1 ID: 1.10 (28)
FF5226  KUBOTA 1522143080 Product is not available in all regions of the world. Gasket: 3848018 Overall Height: 3.09 (78) Largest OD: 3.03 (77) Thread Size: M20 X 1.5-6H INT	FF5238  AMERICAN MOTORS 8933000076 Overall Height: 5.99 (152) Inlet Connection: 0.37 Outlet Connection: 0.32 Largest element OD: 2.88 (73)	FF5259  YANMAR 12455055700, HITACHI 4313065, KUBOTA 1627143560 Gasket: 3328934 Overall Height: 3.48 (89) Overall OD: 1.38 (35) End 1 ID: 0.44 (11)
FF5227  Extended change interval secondary fuel filter for DDC applications installed on Davco 321 head assembly. Overall Height: 8.11 (206) Largest OD: 4.26 (108) Thread Size: 13/16-12 UNS-2B	FF5239  CASE D145357 Overall Height: 3.90 (99) Inlet Connection: 0.375 Outlet Connection: 0.375 Largest element OD: 1.91 (48)	FF5260  YANMAR 10450055710 Gasket: 3328934 Overall Height: 2.74 (70) Overall OD: 1.38 (35) End 1 ID: 0.44 (11)

E. PRODUCT GUIDE

FF5263  CARRIER 305030300 Overall Height: 6.45 (164) Largest OD: 3.69 (94) Thread Size: 11/16-16 UN-2B	FF5277  THERMO-KING 116286 Height: 2.33 (59) Length: 4.62 (117) Width: 2.46 (62)	FF5288  Is a longer version of FF5430 General application - Plastic In-Line Prefilter Overall Height: 8.11 (206) Inlet Connection: 4.5 Outlet Connection: 4.5 Largest element OD: 1.81 (46)
FF5264  CATERPILLAR 1R0712 Fits same head as FF211 but smaller in size for primary filtration. Overall Height: 9.47 (241) Largest OD: 3.68 (93) Thread Size: 1-14 UNS-2B	FF5279  MITSUBISHI 3166201031 Overall Height: 1.73 (44) Overall OD: 2.84 (72) End 1 ID: 0.75 (19)	FF5289  CASE 194199A1 Overall Height: 4.33 (110) Inlet Connection: .5 Outlet Connection: .5 Largest element OD: 1.91 (48)
FF5266  NISSAN FL40305D00 Gasket: 3311920 Overall Height: 5.48 (139) Largest OD: 3.69 (94) Thread Size: 3/4-16 UNF-2B	FF5280  LOMBARDINI 500217532 Overall Height: 2.05 (52) Overall OD: 1.65 (42) End 1 ID: 0.56 (14) End 2 ID: 0.35 (9)	FF5290  DAVCO 320120 For 321 system(w/ fill port) Overall Height: 7.91 (201) Largest OD: 4.25 (108) Thread Size: 1-14 UNS-2B
FF5267  NISSAN 16444Z9027 Overall Height: 6.31 (160) Overall OD: 3.62 (92) End 1 ID: 0.59 (15)	FF5281  LOMBARDINI 2732175009 Overall Height: 2.05 (52) Overall OD: 2.05 (52) End 1 ID: 0.56 (14) End 2 ID: 0.35 (9)	FF5294  PSA ZQ00034180 Overall Height: 4.06 (103) Inlet Connection: 9 Outlet Connection: 9 Largest element OD: 2.05 (52)
FF5269  INTERNATIONAL TRUCKS 1822588C1 Is a short version of FF5078 Overall Height: 7.14 (181) Largest OD: 4.24 (108) Thread Size: 7/8-14 UNF-2B	FF5282  KUBOTA 1560143170 Overall Height: 4.14 (105) Largest OD: 3.78 (96) Thread Size: M20 X 1.5-6H INT	FF5297  SCANIA 1372444 Overall Height: 5.59 (142) Largest OD: 3.68 (94) Thread Size: M24 X 1.5-6H INT
FF5272  VOLVO 420799, VOLVO 8193841 For Stratapore version, use FF5443 High efficiency Overall Height: 8.27 (210) Largest OD: 3.68 (94) Thread Size: M18 X 1.5-6H INT	FF5284  IVECO 1907640 Overall Height: 5.91 (150) Largest OD: 3.05 (78) Thread Size: M16 X 1.5-6H INT	FF5298  DAF 1318695 Filter used with 3918190S For Stratapore version, use FF5313 Overall Height: 5.61 (143) Largest OD: 3.70 (94) Thread Size: M16 X 1.5-6H INT
FF5275  THERMO-KING 117264 Height: 2.33 (59) Length: 4.62 (117) Width: 2.46 (62)	FF5285  CUMMINS 3890017 For separator version, use FS1280 Use for Marine Applications Overall Height: 5.46 (139) Largest OD: 3.69 (94) Thread Size: 13/16-18 UNS-2B	FF5300  MITSUBISHI 3446200300 . Overall Height: 3.94 (100) Largest OD: 3.29 (84) Thread Size: M20 X 1.5-6H INT
FF5276  THERMO-KING 116285 Height: 2.33 (59) Length: 4.62 (117) Width: 2.46 (62)	FF5287  LEYLAND ABU9642 Overall Height: 3.43 (87) End 1 OD: 3.47 (88) End 2 OD: 3.31 (84) End 1 ID: 0.74 (19) End 2 ID: 1.50 (38)	FF5301  CARRIER 300109000 Overall Height: 5.20 (132) Largest OD: 4.26 (108) Thread Size: 1-14 UNS-2B

E. PRODUCT GUIDE

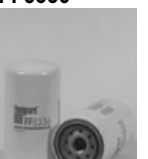
<p>FF5303 PURFLUX C130 Uses service part: 3960274S</p>  <p>Overall Height: 7.99 (203) Overall OD: 4.11 (105) End 1 ID: 1.28 (33)</p>	<p>FF5316 GEHL 79757</p>  <p>Overall Height: 3.19 (81) Largest OD: 3.68 (93) Thread Size: M20 X 1.5-6H INT</p>	<p>FF5329 CARRIER 305030101 Same as FF200 w/o drain</p>  <p>Overall Height: 5.76 (146) Largest OD: 3.69 (94) Thread Size: 13/16-18 UNS-2B</p>
<p>FF5304 KOMATSU 6003118222 Is a short version of FF5058</p>  <p>Overall Height: 4.58 (116) Largest OD: 3.06 (78) Thread Size: 3/4-16 UNF-2B</p>	<p>FF5317 CATERPILLAR 1R0755</p>  <p>Overall Height: 12.17 (309) Largest OD: 5.41 (137) Thread Size: 1 3/8-16 UNS-2B</p>	<p>FF5330 CARRIER 305030110 Similar to FF5056 w/o drain</p>  <p>Overall Height: 5.42 (138) Largest OD: 3.69 (94) Thread Size: 13/16-18 UNS-2B</p>
<p>FF5305 CUMMINS 3900876</p>  <p>Overall Height: 5.91 (150) Overall OD: 2.82 (72) End 1 ID: 1.77 (45) End 2 ID: 0.32 (8)</p>	<p>FF5319 CATERPILLAR 1R0749</p>  <p>Overall Height: 9.47 (241) Largest OD: 3.68 (93) Thread Size: 1-14 UNS-2B</p>	<p>FF5331 CARRIER 305030301 Similar to FF5263 w/o drain</p>  <p>Overall Height: 5.42 (138) Largest OD: 3.69 (94) Thread Size: 11/16-16 UN-2B</p>
<p>FF5307 NISSAN 1640359E00</p>  <p>Overall Height: 5.75 (146) Largest OD: 3.86 (98) Thread Size: 3/4-16 UNF-2B</p>	<p>FF5320 CATERPILLAR 1R0750</p>  <p>Overall Height: 6.94 (176) Largest OD: 3.68 (93) Thread Size: 1-14 UNS-2B</p>	<p>FF5332 DONALDSON EFF9090 Upgrade of FF105 Synthetic Media Version</p>  <p>Overall Height: 5.41 (137) Largest OD: 3.70 (94) Thread Size: 1-14 UNS-2B</p>
<p>FF5310 CUMMINS 3931072</p>  <p>Overall Height: 4.16 (106) Inlet Connection: 3/4-16 UNF-2A Outlet Connection: .325 HOSE Largest element OD: 1.91 (48)</p>	<p>FF5321 ATLAS COPCO 3222310756</p>  <p>Overall Height: 6.92 (176) Largest OD: 3.68 (93) Thread Size: 7/8-14 UNF-2B</p>	<p>FF5333 DONALDSON EFF9091 Upgrade of FF5206 Synthetic media version</p>  <p>Overall Height: 6.91 (176) Largest OD: 3.67 (93) Thread Size: 13/16-12 UNS-2B</p>
<p>FF5311 DAVCO 321 Head Assembly Secondary fuel for DDC applications Longer version of FF5227</p>  <p>Overall Height: 10.44 (265) Largest OD: 4.26 (108) Thread Size: 13/16-12 UNS-2B</p>	<p>FF5322 CATERPILLAR 1R0753</p>  <p>Overall Height: 9.47 (241) Largest OD: 3.68 (93) Thread Size: 7/8-14 UNF-2B</p>	<p>FF5334 DONALDSON EFF9093 Upgrade of FF104 Synthetic Media Version</p>  <p>Overall Height: 4.15 (105) Largest OD: 3.70 (94) Thread Size: 1-14 UNS-2B</p>
<p>FF5312 V.A.G. (VOLKSWAGEN, AUDI) 191127401A</p>  <p>Overall Height: 6.85 (174) Largest OD: 3.47 (88) Standpipe: YES Thread Size: NO</p>	<p>FF5323 CATERPILLAR 1R0756 Uses service part: 3940104S Upgrade of FF5337</p>  <p>Gasket: 3940104S Overall Height: 9.23 (234) Overall OD: 3.92 (100) End 1 ID: 1.61 (41)</p>	<p>FF5335 DONALDSON EFF9095 Upgrade of FF5021 Synthetic Media Version</p>  <p>Overall Height: 4.31 (109) Largest OD: 3.70 (94) Thread Size: 13/16-12 UNS-2B</p>
<p>FF5313 DAF 1309511 Stratapore version of FF4070, FF5298 High efficiency</p>  <p>Overall Height: 8.31 (211) Largest OD: 3.70 (94) Thread Size: M16 X 1.5-6H INT</p>	<p>FF5324 CATERPILLAR 1R0751, CATERPILLAR 1R0759</p>  <p>Overall Height: 7.09 (180) Largest OD: 3.34 (85) Thread Size: 7/8-14 UNF-2B</p>	<p>FF5336 DONALDSON EFF9096 Upgrade of FF185 Synthetic Media Version</p>  <p>Overall Height: 6.94 (176) Largest OD: 3.68 (93) Thread Size: 1-14 UNS-2B</p>

E. PRODUCT GUIDE

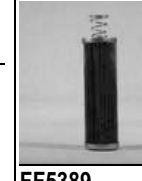
FF5337  CATERPILLAR 8N9850 Uses service part: 3940104S For Upgrade, use FF5323 Gasket: 3940104S Overall Height: 9.23 (234) Overall OD: 3.92 (100) End 1 ID: 1.61 (41)	FF5366  DAF 1345335 Overall Height: 5.61 (143) Largest OD: 3.70 (94) Thread Size: M22 X 1.5-6H INT	FF5381  MACK 483GB470M For separator version, use FS19537 Overall Height: 8.06 (205) Largest OD: 4.26 (108) Thread Size: M22 X 1.5-6H INT
FF5346  Upgrade of FF202 Synthetic Media Version Overall Height: 11.31 (287) Largest OD: 4.57 (116) Thread Size: 1 1/4-12 UNS-2B	FF5367  MITSUBISHI ME056670 Overall Height: 6.91 (176) Largest OD: 3.69 (94) Thread Size: M24 X 1.5-6H INT	FF5382  MACK 483GB471M Overall Height: 10.39 (264) Largest OD: 4.26 (108) Thread Size: M30 X 1.5-6H INT
FF5347  DONALDSON EFF9097 Upgrade of FF171 Synthetic Media Version Overall Height: 8.11 (206) Largest OD: 4.26 (108) Thread Size: 7/8-16 UN-2B	FF5368  NISSAN 1640501T70 Overall Height: 6.89 (175) Largest OD: 3.31 (84) Thread Size: 3/4-16 UNF-2B	FF5383  HITACHI 4121496 Overall Height: 5.75 (146) Largest OD: 3.00 (76) End 1 ID: 2.25 (57)
FF5348  DONALDSON EFF9098 Upgrade of FF222 Synthetic Media Version Overall Height: 10.39 (264) Largest OD: 4.26 (108) Thread Size: 1 1/16-16 UN-2B	FF5369W  Uses service part: 3912384S For Upgrade, use FS1029W, FS19536 Davco 380 assembly replacement cartridge. Includes gasket. Gasket: 3901455 (1), 3901456(1), 3926140 Overall Height: 7.03 (179) Overall OD: 3.82 (97) End 1 ID: 0.66 (17)	FF5384  HITACHI 499682 May not be available in all regions of the world Overall Height: 1.50 (38) Largest OD: 1.75 (44) End 1 ID: .50 (13)
FF5354  PURFLUX C131 Uses service part: 3960274S Overall Height: 11.81 (300) Overall OD: 4.11 (105) End 1 ID: 1.28 (33)	FF5370  FINN FFP1053015 Overall Height: 8.07 (205) Overall OD: 7.07 (180) End 1 ID: 4.11 (105)	FF5385  TOYOTA 423438010 Overall Height: 2.91 (74) Overall OD: 2.92 (74) End 1 ID: 0.58 (15)
FF5359  ISUZU 1878103670 Overall Height: 8.19 (208) Overall OD: 4.33 (110) End 1 ID: 1.77 (45)	FF5373  MERCEDES-BENZ 10922301 Mercedes Benz 001 092 22 01 Overall Height: 4.19 (107) Largest OD: 3.47 (88) Thread Size: M12 X 1.5-6H INT	FF5386  YANMAR 17108155910 Overall Height: 2.01 (51) Overall OD: 1.38 (35) End 1 ID: 0.45 (12)
FF5360  MITSUBISHI ME016841 Overall Height: 4.69 (119) Overall OD: 3.58 (91) End 1 ID: 1.34 (34)	FF5374  ISUZU 8944080780 Overall Height: 1.33 (34) Overall OD: 0.50 (13) End 1 ID: 0.25 (6)	FF5387  MAZDA TF0113480 Overall Height: 3.97 (101) Largest OD: 3.31 (84) Thread Size: M20x1.5-6H
FF5363  ISUZU 1132401940 Overall Height: 3.86 (98) Overall OD: 3.74 (95) End 1 ID: 1.12 (29)	FF5376  ISUZU 1873100940 Overall Height: 6.95 (177) Largest OD: 3.73 (95) Thread Size: 1-14 UNS-2B	FF5388  CLARK FL2W Overall Height: 8.81 (224) Overall OD: 2.75 (70) End 1 ID: 1.18 (30)
FF5364  VALMET 836010943 Gasket: 3910955 Overall Height: 3.53 (90) Overall OD: 2.80 (71) End 1 ID: 1.34 (34)	FF5380  MERCEDES-BENZ 901251 Overall Height: 4.08 (104) Overall OD: 3.62 (92) End 1 ID: 1.06 (27) End 2 ID: 0.28 (7)	FF5389  Locomotive Fuel Overall Height: 29.38 (746) Overall OD: 6.40 (163) End 1 ID: 1.46 (37)

E. PRODUCT GUIDE

FF5390 EMD/GENERAL MOTORS 40074677



Overall Height: 29.38 (746)
Overall OD: 9.80 (249)
End 1 ID: 1.47 (37)

FF5391 TOYOTA 423448012



Overall Height: 2.47 (63)
Overall OD: 2.49 (63)
End 1 ID: 0.57 (15)

FF5392 DAVCO 230029 Uses service part: 3901993S For Upgrade, use FS19550 Davco replacement



Gasket: 3919005 (1), 3919006(1)
Overall Height: 4.32 (110)
End 1 OD: 3.50 (89)
End 2 OD: 3.48 (88)
End 1 ID: 0.66 (17)

FF5393 CLARK HA1P1S, GENERAL ELECTRIC 132X1570



Overall Height: 29.38 (746)
Overall OD: 9.80 (249)
End 1 ID: 1.47 (37)

FF5394 ISUZU 8941329471



Thread Size: 3/4-16

FF5398 ALCO 18311122, CLARK FA2



Overall Height: 20.94 (532)
Overall OD: 5.06 (129)
End 1 ID: 0.69 (18)

FF5405 MERCEDES-BENZ 5410900051 For use in Hengst Housing



Overall Height: 7.97 (202)
End 1 OD: 4.17 (106)
End 2 OD: 3.74 (95)
End 1 ID: 1.81 (46)
End 2 ID: 0.55 (14)

FF5406 M.A.N. 55512503002



Overall Height: 5.19 (132)
Largest OD: 3.78 (96)
Thread Size: 1 X 11 BSP

FF5407 DAIHATSU 233038730800, DAIHATSU 233038730900



Overall Height: 5.62 (143)
Largest OD: 3.86 (98)
Thread Size: M20 X 1.5

FF5412 TOYOTA 233907600171



Overall Height: 5.14 (131)
Largest OD: 3.70 (94)
Thread Size: 3/4-16 UNF-2B

FF5415 YANMAR 41650501140



Overall Height: 274
Overall OD: 5.04 (128)
End 1 ID: 2.21 (56)

FF5416 FIAT HITACHI 71497012, HITACHI 4237660



Overall Height: 7.75 (197)
Overall OD: 7.88 (200)
End 1 ID: 4.50 (114)

FF5417 HITACHI 4353560



Overall Height: 9.19 (233)
Overall OD: 2.75 (70)
End 1 ID: 1.94 (49)

FF5418 FORD F81Z9N184AA, FORD F81A9A184AA



Overall Height: 2.75 (70)
Overall OD: 3.25 (83)
End 1 ID: 0.61 (15)

FF5419 VOKES C6357738-38



Overall Height: 10.83 (275)
Overall OD: 4.53 (115)
End 1 ID: 2.56 (65)

FF5421 CUMMINS 4897897 Filter used with 3940777S, 3960461S Uses service part: 3948239S Used with 3944776



Overall Height: 7.58 (193)
Largest OD: 3.72 (95)
Thread Size: M20 X 1.5-6H INT

FF5422 KHD(KLOCKNER-HUMBOLDT-DEUTZ) 1174696 Is a short version of FF5404 Product is not available in all regions of the world.



Overall Height: 3.22 (82)
Largest OD: 2.99 (76)
Thread Size: M16 X 1.5 - 6H

FF5425 RENAULT V.I. 5010359706 For Stratapore version, use FF5445



Overall Height: 5.61 (143)
Largest OD: 3.68 (94)
Thread Size: M16 X 1.5-6H INT

FF5426 KOMATSU 6003118283 Komatsu Applications



Overall Height: 6.10 (155)
Largest OD: 3.73 (95)
Thread Size: 1-14 UNS-2B

FF5427 LIEBHERR 738204523



Overall Height: 5.64 (143)
Largest OD: 3.72 (95)
Thread Size: M16 X 1.5-6H INT

FF5430 Is a short version of FF5288 General applications



Overall Height: 4.86 (124)
Inlet Connection: 4
Outlet Connection: 4
Largest element OD: 1.99 (51)

FF5432 TOYOTA 2339064450, CUMMINS C6003112110, KOMATSU 6003112110



Overall Height: 4.86 (124)
Largest OD: 2.84 (72)
Thread Size: 3/4 16UNF 2B INT

FF5442 Stratapore version of FF5074



Overall Height: 4.92 (125)
Largest OD: 3.05 (78)
Thread Size: M16 X 1.5-6H INT

FF5443 Stratapore version of FF5272



Overall Height: 8.27 (210)
Largest OD: 3.68 (94)
Thread Size: M18 X 1.5-6H INT

FF5444 Is a Stratapore Version of FF5271



Overall Height: 4.92 (125)
Largest OD: 3.05 (78)
Thread Size: M16 X 1.5-6H INT

FF5445 Stratapore version of FF5425



Overall Height: 5.61 (143)
Largest OD: 3.68 (94)
Thread Size: M16 X 1.5-6H INT

FF5446 TOYOTA 238542347071



Overall Height: 2.74 (70)
Overall OD: 1.47 (37)
End 1 ID: 0.47 (12)

FF5450 CIM-TEK 70019



Overall Height: 11.00 (279)
Largest OD: 5.06 (129)
Thread Size: 1 1/2-16-UN 2B

E. PRODUCT GUIDE

FF5451 INGERSOLL-RAND 54381306
Ingersoll Rand Compressors



Overall Height: 3.22 (82)
Largest OD: 3.31 (84)
Thread Size: 3/4-16 UNF-2B

FF5454 WIX 24104, BALDWIN
BF7609 Oil Burning Furnaces,
Heaters



Overall Height: 4.34 (110)
Largest OD: 2.63 (67)
Thread Size: 1-14 UNF-2B

FF5455 FORD F89Z9155A



Overall Height: 7.08 (180)
Inlet Connection: 5/16 HOSE
Outlet Connection: 5/16 HOSE
Largest element OD: 2.16 (55)

FF5456 WIX 33293, FORD
E9SZ9155A



Overall Height: 5.85 (148)
Inlet Connection: 5/16 HOSE
Outlet Connection: 5/16 HOSE
Largest element OD: 2.00 (51)

FF5457 IVECO 2991585



Overall Height: 8.27 (210)
Largest OD: 3.68 (94)
Thread Size: M16 X 1.5-6H INT

FF5458 CARRIER 300109001



Overall Height: 5.93 (151)
Largest OD: 4.39 (112)
Thread Size: 1-14 UNS-2B

FF5461 Stratapore version of FF5018
KHD applications



Overall Height: 4.92 (125)
Largest OD: 3.05 (78)
Standpipe: YES
Thread Size: M16 X 1.5-6H INT

FF5462 Has an "E Coating" applied to
the element to prevent rust
and other problems.



Overall Height: 3.86 (98)
Inlet Connection: 0.375 (9.5)
Outlet Connection: 0.375 (9.5)
Largest element OD: 1.94 (49)

FF5465 VOKES B6436169



Overall Height: 9.02 (229)
Overall OD: 3.66 (93)
End 1 ID: 1.69 (43)
End 2 ID: 0.62 (16)

FF5468 KUBOTA 1583143380



Overall Height: 2.76 (70)
Overall OD: 1.38 (35)
End 2 ID: 0.45 (12)

FF5470 RENAULT V.I. 5001853860
Stratapore inside



Overall Height: 5.61 (143)
Largest OD: 3.70 (94)
Thread Size: M18 X 1.5-6H INT

FF5471 IVECO 500315480



Overall Height: 6.68 (170)
Largest OD: 4.25 (108)
Thread Size: M16 X 1.5-6H INT

FF5474 CIM-TEK 70814



Overall Height: 10.71 (272)
Largest OD: 5.08 (129)
Thread Size: 1 1/2-16 UN-2B MOD

FF5480 ONAN 149220601



Overall Height: 4.13 (105)
Largest element OD: 1.42 (36)

FF5481 M.A.N. 51125030042



Overall Height: 9.02 (229)
Overall OD: 2.99 (76)
End 1 ID: 1.06 (27)
End 2 ID: 0.45 (12)

FF5482 KAYDON KF601815 Fuel
version of the HF6063 used in
Kaydon housings VKS1,
VKS2, VKS6



Overall Height: 17.88 (454)
Overall OD: 6.19 (157)
End 1 ID: 2.56 (65)

FF5483 FORD 1015734



Overall Height: 5.47 (139)
Largest OD: 3.54 (90)
Standpipe: YES
Thread Size: NONE

FF5485 DAF 1399760, CUMMINS
4897833



Overall Height: 7.58 (193)
Largest OD: 3.68 (94)
Thread Size: M20 X 1.5-6H INT

FF5487 JOHN DEERE RE38818 John
Deere 744H Loader



Overall Height: 3.66 (93)
Inlet Connection: M14 X 1.5
Outlet Connection: .5
Largest element OD: 1.94 (49)

FF5488 CUMMINS 3959612



Overall Height: 6.92 (176)
Largest OD: 3.68 (93)
Thread Size: 7/8-14 UNF-2B

FF5503 GMC 25121293



Overall Height: 5.52 (140)
Inlet Connection: 0.375
Outlet Connection: M16 X 1.5
Largest element OD: 2.16 (55)

FF5504 CHRYSLER 4809117AB



FF5506 JOHN DEERE RE506428
John Deere 744H Loader



Overall Height: 5.67 (144)
Largest OD: 4.33 (110)
Thread Size: 7/8-14 UNF-2B

FF5507 VOLVO 20430751 Outside/In
flow. Volvo Truck EGR
Engine.



Overall Height: 10.39 (264)
Largest OD: 4.24 (108)
Thread Size: M32 X 1.5-6H INT

FF5510 DAF 1397766



Overall Height: 8.03 (204)
End 1 OD: 4.09 (104)
End 2 OD: 3.58 (91)
End 1 ID: 1.77 (45)
End 2 ID: 0.53 (14)

FF5527 CATERPILLAR 9M2341



Overall Height: 2.99 (76)
Overall OD: 2.19 (56)

FF5578 KOMATSU 6003118321































Overall Height: 5.81 (148)
Largest OD: 3.73 (95)
Thread Size: 1-14 UNS-2B

FF5580 Cummins QSC, QSL Tier 3
2005

















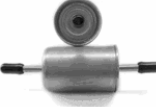

Overall Height: 6.92 (176)
Largest OD: 3.68 (93)
Thread Size: 7/8-14 UNF-2B











E. PRODUCT GUIDE

FF5582  VALMET 6605860 2 required to replace FF5124 Overall Height: 4.53 (115) Overall OD: 2.55 (65) End 1 ID: 0.54 (14)	FF5617  FUEL PREPORATOR FF80-10 Overall Height: 5.91 (150) Largest OD: 3.05 (77) Thread Size: 7/8-14 UNF-2B	FF5633  M.T.U. 20922801 Overall Height: 10.26 (261) Largest OD: 4.33 (110) Thread Size: M32 X 1.5-6H INT
FF5584  KHD(KLOCKNER-HUMBOLDT-DEUTZ) 2931168 Overall Height: 4.72 (120) Overall OD: 3.33 (85) End 1 ID: 0.54 (14)	FF5618  Fuel Island Filtration Applications Gasket: 332418 (1) Overall Height: 10.71 (272) Largest OD: 5.08 (129) Thread Size: 1 1/2-16 UN-2B MOD	FF5636  CUMMINS 4940647 Used with 4990861 Cummins ISC07 Overall Height: 6.92 (176) Largest OD: 3.68 (93) Thread Size: 7/8-14 UNF-2B
FF5588  DIESEL PERFORMANCE PRODUCTS FF1010 Overall Height: 8.00 (203) Largest OD: 3.75 (95) Thread Size: 1 1/2-16 UN-2B	FF5619  MERCEDES-BENZ 6110920201 Overall Height: 4.92 (125) Largest OD: 3.58 (91) Thread Size: NONE	FF5637  AC TP1298B Overall Height: 6.36 (162) Largest OD: 4.02 (102) Thread Size: 3 3/8-8 BUTT-2B
FF5599  CASE 87300040, NEW HOLLAND 87300039 Case and New Holland Compact Tractor Applications Overall Height: 2.27 (58) Overall OD: 1.14 (29) End 1 ID: 0.52 (13)	FF5621  GMC 25055347 Overall Height: 4.34 (110) Inlet Connection: .500 Outlet Connection: .500 Largest element OD: 1.94 (49)	FF5638  CUMMINS 4946635 Overall Height: 5.83 (148) Largest OD: 3.23 (82) Thread Size: M22 x 1.5-6H INT
FF5601  FUEL PREPORATOR FF135 Overall Height: 10.71 (272) Largest OD: 5.08 (129) Thread Size: 1 1/2-16 UN-2B MOD	FF5624  CATERPILLAR 1R0762 For Caterpillar Applications that use Head 145-1790 Overall Height: 10.61 (269) Largest OD: 3.70 (94) Thread Size: 1-14 UNS-2B	FF5641  M.T.U. 20920601 Overall Height: 5.61 (143) Largest OD: 3.72 (95) Thread Size: 1-12 UNF-2B
FF5609  DAVCO 102538 Cummins ISX engines Overall Height: 10.44 (265) Largest OD: 4.26 (108) Thread Size: 13/16-12 UNS-2B	FF5625  MERCEDES-BENZ 6120920001 Overall Height: 4.78 (122) Largest OD: 3.58 (91) Thread Size: NONE	FF5642  M.T.U. 20921901 Overall Height: 5.61 (143) Largest OD: 3.72 (95) Thread Size: 1-12 UNF-2B
FF5612  CUMMINS 4897897 Overall Height: 6.95 (177) Largest OD: 3.73 (95) Thread Size: M20 X 1.5-6H INT	FF5626  SCANIA 1763776 Overall Height: 5.60 (142) Largest OD: 3.70 (94) Thread Size: M24 X 1.5-6H INT	FF5643  MACK 483GB476M Overall Height: 8.09 (205) Largest OD: 4.26 (108) Thread Size: M30 X 1.5-6H INT
FF5613  Light Duty Automotive Diesel Engines. Same as FF5587, but different micron rating. FUEL PREPORATOR FF80-3 Overall Height: 5.91 (150) Largest OD: 3.05 (77) Thread Size: 7/8-14 UNF-2B	FF5629  M.A.N. 51125030061 Overall Height: 6.81 (173) Overall OD: 3.58 (91) End 1 ID: 1.77 (45) End 2 ID: 0.53 (14)	FF5644  CUMMINS 4964234 Hi-Efficiency filter for Cummins Hi-Horsepower engines Overall Height: 10.501 (266.73) OD: 4.66 (118.36) Thread Size: 2 1/4 - 12 UNS - 2B
FF5616  EUCLID E12978047 Overall Height: 8.98 (228) Largest OD: 4.70 (119) Thread Size: 1 1/16-16 UNS-2B	FF5630  RENAULT AGRICULTURE 7701012556 Overall Height: 3.27 (83) Overall OD: 2.44 (62) End 1 ID: 0.52 (13)	FF5645  VOLVO 11708555 Overall Height: 4.57 (116) Largest OD: 3.68 (94) Thread Size: M16 X 1.5-6H INT
	FF5632  CUMMINS 4934845 Used with 4990860 Cummins ISB07 Overall Height: 7.94 (202) Largest OD: 3.68 (93) Thread Size: M20 X 1.5-6H INT	

E. PRODUCT GUIDE

	FF5647 MERCEDES-BENZ 6110920101, MERCEDES- BENZ A6110920101 Overall Height: 4.78 (122) Largest OD: 3.58 (91) Thread Size: NONE
	FF5659 CHRYSLER 4864307 Mexico only Overall Height: 1.61 (41) Overall OD: 5.0 (127) End 1 ID: 3.27 (83)
	FF5660 FORD 88TY9155AA Mexico only Overall Height: 3.03 (77) Inlet Connection: 1/2-20 Outlet Connection: 1/2-20 Largest element OD: 1.65 (42)
	FF5661 FORD YL5Z9155AD Mexico only Overall Height: 6.30 (160) Inlet Connection: 5/16 3/8 Outlet Connection: 5/16 Largest element OD: 2.13 (54)
	FF5662 Mexico only Overall Height: 3.11 (79) Inlet Connection: 3/8 Outlet Connection: M16X1.5 Largest element OD: 2.17 (55)
	FF5663 CHRYSLER 52025447 Mexico only Overall Height: 3.74 (95) Inlet Connection: 1/4 Outlet Connection: 3/8 Largest element OD: 2.99 (76)
	FF5664 CHRYSLER 52004611 Mexico only Overall Height: 5.47 (139) Inlet Connection: 5/16 Outlet Connection: 5/16 Largest element OD: 2.17 (55)
	FF5665 GMC 25055046 Mexico only Overall Height: 4.33 (110) Inlet Connection: M16X1.5-6H Outlet Connection: M16X1.5-6H Largest element OD: 2.17 (55)
	FF5666 FORD F0TZ9155B Mexico only Overall Height: 6.73 (171) Inlet Connection: 5/16 Outlet Connection: 5/16 Largest element OD: 2.99 (76)
	FF5667 CHRYSLER 7680997 Mexico only Overall Height: 4.49 (114) Largest element OD: 1.91 (49)

	FF5668 FORD F0TE9155AA Mexico only Overall Height: 7.09 (180) Largest element OD: 2.01 (51)
	FF5669 Mexico only Overall Height: 3.98 (101) Inlet Connection: 5/16 Outlet Connection: 5/16 Largest element OD: 1.65 (42)
	FF5670 GMC 25055117 Mexico only Overall Height: 1.93 (49) Inlet Connection: 1/8 Outlet Connection: 1/2 Largest element OD: 1.10 (28)
	FF5671 GMC 25176294 Mexico only. Overall Height: 4.92 (125) Inlet Connection: 5/16 Outlet Connection: 5/16 Largest element OD: 2.87 (73)
	FF5672 CHRYSLER 4186209 Mexico only Overall Height: 4.02 (102) Inlet Connection: 5/16 Outlet Connection: 5/16 Largest element OD: 1.65 (42)
	FF5673 GMC 25121468 Mexico only Overall Height: 6.38 (162) Largest element OD: 2.17 (55)
	FF5674 FORD C4AZ9365A Overall Height: 3.54 (90) Overall OD: 2.09 (53)
	FF5675 GMC 25055052 Mexico only Overall Height: 5.33 (135) Inlet Connection: 5/16 Outlet Connection: 5/16 Largest element OD: 2.17 (55)
	FF5676 FORD D1FZ9155A Mexico only Overall Height: 3.07 (78) Largest element OD: 0.75 (19)
	FF5677 Mexico only Overall Height: 4.41 (112) Outlet Connection: 3/8 Largest element OD: 1.75 (44)

	FF5678 NISSAN 1640041B00 Mexico only Overall Height: 4.80 (122) Largest element OD: 2.20 (56)
	FF5679 GMC 5651775 Mexico only Overall Height: 3.27 (83) Inlet Connection: 1/4 Outlet Connection: 1/4 Largest element OD: 1.57 (40)
	FF5680 NISSAN 1640010Y00 Mexico only Overall Height: 4.76 (121) Inlet Connection: 5/16 Outlet Connection: 5/16 Largest element OD: 2.20 (56)
	FF5682 HYUNDAI 3197643670 Overall Height: 6.52 (166) Inlet Connection: 5/16 Outlet Connection: 5/16 Largest element OD: 2.17 (55)
	FF5683 SCANIA 1873018 Overall Height: 7.41 (188) End 1 OD: 3.35 (85) End 2 OD: 3.41 (87) End 1 ID: 1.46 (37)
	FF5684 SCANIA 1873016 Overall Height: 7.41 (188) End 1 OD: 3.35 (85) End 2 OD: 3.31 (84) End 1 ID: 1.46 (37)
	FF5685 GENERAL MOTORS 25161333 Overall Height: 3.43 (87) Inlet Connection: M12X1.25 Outlet Connection: M12X1.25 Largest element OD: 2.17 (55)
	FF5690 DETROIT DIESEL 23530645 Overall Height: 6.91 (176) Largest OD: 3.67 (93) Thread Size: 13/16-12 UNS-2B
	FF5692 MERCEDES-BENZ A6460920701 Overall Height: 5.06 (129) Largest OD: 3.59 (91) Thread Size: NONE
	FF5693 CUMMINS 4095189, KOMATSU 6003113110 For Upgrade, use FS1006 Overall Height: 12.32 (313) Largest OD: 4.74 (120) Standpipe: YES Thread Size: 1 1/4-12 UNS-2B

FF5695 DAF 1643080
 Overall Height: 9.83 (250)
 End 1 OD: 3.54 (90)
 End 2 OD: 4.13 (105)
 End 1 ID: 0.78 (20)
 End 2 ID: 1.81 (46)

FF5698 MAHLE KL2282D
 Overall Height: 4.29 (109)
 Inlet Connection: 1.36
 Outlet Connection: 1.06
 Largest element OD: 3.41 (87)

FF5699 DAHL 30130
 Overall Height: 9.68 (246)
 Overall OD: 6.07 (154)
 End 1 ID: 1.48 (38)

FF5700 FORD 2L5Z9155A, MAZDA 1F2013470
 Overall Height: 6.38 (162)
 Inlet Connection: .433
 Outlet Connection: .433
 Largest element OD: 2.00 (51)

FF5703 TOYOTA 2330020040
 Overall Height: 4.17 (106)
 Inlet Connection: M14X1.5-6H
 Outlet Connection: 0.311
 Largest element OD: 2.56 (65)

FF5704 NISSAN 164009E000, NISSAN 1640072L10
 Overall Height: 4.88 (124)
 Inlet Connection: .374
 Outlet Connection: .374
 Largest element OD: 2.44 (62)

FF5705 MERCEDES-BENZ 14772101
 Overall Height: 4.05 (103)
 Inlet Connection: 0.315
 Outlet Connection: 0.315
 Largest element OD: 1.38 (35)

FF42000 CUMMINS 3903640, CUMMINS 3931065, VOLVO 36845, RENAULT V.I. 5000814227, KHD(KLOCKNER-HUMBOLDT-DEUTZ) Q1H4117, VOLVO 243004, GMC 25011214, CUMMINS 4990879 Product is not available in all regions of the world. Certified for Marine applications.
 Gasket OD: 2.81 (71)
 Overall Height: 4.58 (116)
 Seam OD: 3.24 (82)
 Standpipe: NO
 Thread Size: M16 X 1.5-6H INT



FF42002 FORD E6HZ9365A, KHD(KLOCKNER-HUMBOLDT-DEUTZ) 1174691, KHD(KLOCKNER-HUMBOLDT-DEUTZ) 1174696 Product is not available in all regions of the world.
 Gasket OD: 2.81 (71)
 Overall Height: 3.37 (86)
 Seam OD: 3.24 (82)
 Standpipe: NO
 Thread Size: M16 X 1.5-6H INT



FF42003 KUBOTA 1522143080 Product is not available in all regions of the world.
 Gasket OD: 2.81 (71)
 Overall Height: 3.37 (86)
 Seam OD: 3.24 (82)
 Standpipe: NO
 Thread Size: M20 X 1.5-6H INT



Fuel Housings

FH21001 LEYLAND AENB046 Kit containing filter FS19689, pump, heater w/o thermostat, WIF for Euro 3 applications



FH21011 LEYLAND AENB092 Kit containing filter FS19689, pump, heater w/o thermostat, WIF for Euro 4 applications. [optional] temperature sensor can be fitted



FH21024 FWS module without heater with FS19689

FH21032 FWS module with 24V heater with FS1065

FH21039 LEYLAND AENB718

FH21040 FWS module with 24V heater with FS19732 and heater and WIF harness

FH21044 FWS module without heater with FS19584

FH21049 FWS module without heater with FS19732 and WIF harness

FH23027 DAVCO 382042AMB Housing used with FS19624 Uses service part: 3950445S Fuel Pro Remote Mount Heavy duty engines, fluid heat w/120v and 12v pre-heater Fuel flows up to 180 gph (681 lph)
 Overall Height: 16.25 (413)
 Inlet Connection: 1/2-14 NPTF
 Outlet Connection: 1/2-14 NPTF
 Heater Voltage (DC): 12.00 (12)
 Heater Voltage (AC): 120.00 (120)
 Width: 7.30 (185)



FH23028 DAVCO 382044AMB Housing used with FS19624 Uses service part: 3950445S Fuel Pro Remote Mount Heavy duty engines, fluid heat w/120v and 24v pre-heater Fuel flows up to 180 gph (681 lph)
 Overall Height: 16.25 (413)
 Inlet Connection: 1/2-14 NPTF
 Outlet Connection: 1/2-14 NPTF
 Heater Voltage (DC): 24.00 (24)
 Heater Voltage (AC): 120.00 (120)
 Width: 7.30 (185)



FH23029 DAVCO 382050AMB Housing used with FS19624 Uses service part: 3950445S Fuel Pro Remote Mount Heavy duty engines, unheated Fuel flows up to 180 gph (681 lph)
 Overall Height: 16.00 (406)
 Inlet Connection: 1/2-14 NPTF
 Outlet Connection: 1/2-14 NPTF
 Width: 7.30 (185)



FH23030 DAVCO 382050AMB50 Uses service part: 3950445S Fuel Pro Remote Mount Heavy duty engines, unheated Fuel flows up to 180 gph (681 lph)
 Overall Height: 16.00 (406)
 Inlet Connection: 1/2-14 NPTF
 Outlet Connection: 1/2-14 NPTF
 Width: 7.30 (185)



FH23031 DAVCO 382052AMB Housing used with FS19624 Uses service part: 3950445S Fuel Pro Remote Mount Heavy duty engines, unheated w/12v pre-heater Fuel flows up to 180 gph (681 lph)
 Overall Height: 16.00 (406)
 Inlet Connection: 1/2-14 NPTF
 Outlet Connection: 1/2-14 NPTF
 Heater Voltage (DC): 12.00 (12)
 Width: 7.30 (185)



FH23032 DAVCO 382054AMB Housing used with FS19624 Uses service part: 3950445S Fuel Pro Remote Mount Heavy duty engines, unheated w/ 24v pre-heater Fuel flows up to 180 gph (681 lph)
 Overall Height: 16.00 (406)
 Inlet Connection: 1/2-14 NPTF
 Outlet Connection: 1/2-14 NPTF
 Heater Voltage (DC): 24.00 (24)
 Width: 7.30 (185)



FH23038 DAVCO 382030AMB Housing used with FS19624 Uses service part: 3950445S Fuel Pro Remote mount Heavy duty engines, Fluid Heat Fuel flows up to 180 gph (681 lph)
 Overall Height: 16.25 (413)
 Inlet Connection: 1/2-14 NPTF
 Outlet Connection: 1/2-14 NPTF
 Width: 7.30 (185)



FH23039 DAVCO 382031AMB Housing used with FS19624 Uses service part: 3950445S Fuel Pro Remote mount Heavy duty engines, Fluid Heat, WIF Fuel flows up to 180 gph (681 lph)
 Overall Height: 16.25 (413)
 Inlet Connection: 1/2-14 NPTF
 Outlet Connection: 1/2-14 NPTF
 WIF Sensor: YES
 Width: 7.30 (185)



E. PRODUCT GUIDE

FH23040



DAVCO 382032AMB Housing used with FS19624 Uses service part: 3950445S Fuel Pro Remote mount Heavy duty engines, Fluid heat w/ 12v pre-heater Fuel flows up to 180 gph (681 lph)

Overall Height: 16.25 (413)
Inlet Connection: 1/2-14 NPTF
Outlet Connection: 1/2-14 NPTF
Heater Voltage (DC): 12.00 (12)
Width: 7.30 (185)

FH23041



DAVCO 382033AMB Housing used with FS19624 Uses service part: 3950445S Fuel Pro Remote mount Heavy duty engines, Fluid heat w/12v pre-heater, WIF Fuel flows up to 180 gph (681 lph)

Overall Height: 16.25 (413)
Inlet Connection: 1/2-14 NPTF
Outlet Connection: 1/2-14 NPTF
Heater Voltage (DC): 12.00 (12)
WIF Sensor: YES
Width: 7.30 (185)

FH23042



DAVCO 382034AMB Housing used with FS19624 Uses service part: 3950445S Fuel Pro Remote mount Heavy duty engines, Fluid heat w/ 24v pre-heater Fuel flows up to 180 gph (681 lph)

Overall Height: 16.25 (413)
Inlet Connection: 1/2-14 NPTF
Outlet Connection: 1/2-14 NPTF
Heater Voltage (DC): 24.00 (24)
Width: 7.30 (185)

FH23045



DAVCO 382040AMB Housing used with FS19624 Uses service part: 3950445S Fuel Pro Remote mount Heavy duty engines, Fluid heat w/ 120v pre-heater Fuel flows up to 180 gph (681 lph)

Overall Height: 16.25 (413)
Inlet Connection: 1/2-14 NPTF
Outlet Connection: 1/2-14 NPTF
Heater Voltage (AC): 120.00 (120)
Width: 7.30 (185)

FH23049



DAVCO 382053AMB Housing used with FS19624 Uses service part: 3950445S Fuel Pro Remote mount Heavy duty engines, unheated w/ 12v pre-heater, WIF Fuel flows up to 180 gph (681 lph)

Overall Height: 16.25 (413)
Inlet Connection: 1/2-14 NPTF
Outlet Connection: 1/2-14 NPTF
Heater Voltage (DC): 12.00 (12)
WIF Sensor: YES
Width: 7.30 (185)

FH23050



DAVCO 382055AMB Housing used with FS19624 Uses service part: 3950445S Fuel Pro Remote mount Heavy duty engines, unheated w/24v pre-heater, WIF Fuel flows up to 180 gph (681 lph)

Overall Height: 16.25 (413)
Inlet Connection: 1/2-14 NPTF
Outlet Connection: 1/2-14 NPTF
Heater Voltage (DC): 24.00 (24)
WIF Sensor: YES
Width: 7.30 (185)

FH23054



DAVCO 382062AMB Housing used with FS19624 Uses service part: 3950445S Fuel Pro Remote mount Heavy duty engines, unheated w/12v and 120v -heater Fuel flows up to 180 gph (681 lph)

Overall Height: 16.25 (413)
Inlet Connection: 1/2-14 NPTF
Outlet Connection: 1/2-14 NPTF
Heater Voltage (DC): 24.00 (24)
Width: 7.30 (185)

FH23060



DAVCO 382051AMB25 Uses service part: 3950445S Fuel Pro Remote Mount Heavy duty engines, unheated, WIF, 25 micron filter element FS19765Fuel Flows up to 180 gph (681 lph)

FH23061



DAVCO 382051AMB Uses service part: 3950445S Fuel Pro Remote Mount FWS, Unheated, WIF, 7 micron Elemax plus size filter. Heavy Duty Diesel Engines, Fuel Flows up to 180 gph (681 lph)

FH23067M



DAVCO 382055BM25 Uses service part: 3950445S Fuel Pro Remote mount Heavy duty engines, unheated w/ 24v pre-heater, WIF, 25 micron filter element-FS19765Fuel flows up to 180 gph (681 lph)

Overall Height: 16.25 (413)
Inlet Connection: M22 X 1.5-6G INT
Outlet Connection:M22 X 1.5-6G INT
Heater Voltage (DC): 24.00 (24)
WIF Sensor: YES
Width: 7.30 (185)

FH23068M



DAVCO 382051BM25 Uses service part: 3950445S Fuel Pro Remote mount Heavy duty engines, unheated, WIF, 25 micron filter element-FS19765, plugged ports for heater and thermostat Fuel flows up to 180 gph (681lph)

Overall Height: 16.25 (413)
Inlet Connection: M22 X 1.5-6G INT
Outlet Connection:M22 X 1.5-6G INT
WIF Sensor: YES
Width: 7.30 (185)

FH23069M



DAVCO 382035BM25 Uses service part: 3950445S Fuel Pro Remote mount Heavy duty engines, fluid heat w/ 24v pre-heater, WIF, 25 micron filter element-FS19765Fuel flows up to 180 gph (681 lph)

Overall Height: 16.25 (413)
Inlet Connection: M22 X 1.5-6G INT
Outlet Connection:M22 X 1.5-6G INT
Heater Voltage (DC): 24.00 (24)
WIF Sensor: YES
Width: 7.30 (185)

FH23070

DAVCO 382050B1 Uses service part: 3950445S Fuel Pro Remote mount Heavy duty engines, unheated, 7 micron plus size filter and plugged ports Fuel flows up to 180 gph (681 lph)

Overall Height: 16.25 (413)
Inlet Connection: 1/2-14 NPTF
Outlet Connection: 1/2-14 NPTF
Width: 7.30 (185)

FH23072GM

DAVCO 384030M25 Biodiesel Applications with Fluid Head and Drain Valve, 25 Micron Filter Element

FH23076

FLEETGUARD 382050B25 Fuel Pro Remote Mount Heavy duty engines, unheated Fuel flows up to 180 gph (681 lph)25 Micron

Overall Height: 16.00 (406)
Inlet Connection: 1/2-14 NPTF
Outlet Connection: 1/2-14 NPTF
Width: 7.30 (185)

FH23200



DAVCO 232050RL Housing used with FS19730, FS19785, FS19731 Uses service part: 3945059S, 3945061S, 3945062S, 3945063S, 3950444S, 3951841S Diesel Pro Remote Mount Medium duty engines, unheated Fuel flows up to 60 gph (230 lph)

Overall Height: 13.16 (334)
Inlet Connection: 3/8-18 NPTF
Outlet Connection: 3/8-18 NPTF
Width: 6.25 (159)

FH23201



DAVCO 232054RL Housing used with FS19730, FS19785, FS19731 Uses service part: 3945059S, 3945061S, 3945062S, 3945063S, 3950444S, 3951841S Diesel Pro Remote Mount Medium duty engines, unheated w/ 24 pre-heater Fuel flows up to 60 gph (230 lph)

Overall Height: 14.00 (356)
Inlet Connection: 3/8-18 NPTF
Outlet Connection: 3/8-18 NPTF
Heater Voltage (DC): 24.00 (24)
Width: 6.25 (159)

E. PRODUCT GUIDE

FH23202



DAVCO 232052RL Housing used with FS19730, FS19785, FS19731 Uses service part: 3945059S, 3945061S, 3945062S, 3945063S, 3950444S, 3951841S Diesel Pro Remote Mount Medium Duty Diesel Engines, unheated w/ 12v pre-heater Fuel flows up to 60 gph (230 lph)

Overall Height: 14.00 (356)
Inlet Connection: 3/8-18 NPTF
Outlet Connection: 3/8-18 NPTF
Heater Voltage (DC): 12.00 (12)
Width: 6.25 (159)

FH23209M



DAVCO 232051RLM25 Uses service part: 3950444S Diesel Pro Remote mount Medium duty engines, WIF, 25 micron filter element-FS19785, and plugged ports available for heater/thermostat. Fuel flows up to 60 gph (230 lph)

Overall Height: 15.50 (394)
Inlet Connection: M16 X 1.5-6G EXT
Outlet Connection:M16 X 1.5-6G EXT
WIF Sensor: YES
Width: 6.25 (159)

FH23210M



DAVCO 232055RLM25 Uses service part: 3950444S Diesel Pro Remote mount Medium duty engines, WIF, 25 micron filter element-FS19785, and 24 V DC heater w/thermostat. Fuel flows up to 60 gph (230 lph)

Overall Height: 15.50 (394)
Inlet Connection: M16 X 1.5-6G EXT
Outlet Connection:M16 X 1.5-6G EXT
WIF Sensor: YES
Width: 6.25 (159)

FH23211M



DAVCO 232035RLM25 Uses service part: 3950444S Diesel Pro Remote mount Medium duty engines, WIF, 25 micron filter element-FS19785, fluid heater, and 24 V DC w/thermostat. Fuel flows up to 60 gph (230 lph)

Overall Height: 15.50 (394)
Inlet Connection: M16 X 1.5-6G EXT
Outlet Connection:M16 X 1.5-6G EXT
WIF Sensor: YES
Width: 6.25 (159)

FH23212M



DAVCO 234051RLM251 Biodiesel FH232 w/WIF, 25 micron filter element-FS19785, and plugged ports available for heater/thermostat.

Overall Height: 15.50 (394)
Inlet Connection: M16 X 1.5-6G EXT
Outlet Connection:M16 X 1.5-6G EXT
WIF Sensor: YES
Width: 6.25 (159)

FH23213M



DAVCO 234055RLM25, DAVCO 234055M251, DAVCO 23405RLM25 Biodiesel WIF, 25 micron filter element-FS19785, and 24V DC heater w/thermostat. Fuel flows up to 60 gph (230 lph)

Overall Height: 15.50 (394)
Inlet Connection: M16 X 1.5-6G EXT
Outlet Connection:M16 X 1.5-6G EXT
WIF Sensor: YES
Width: 6.25 (159)

FH23214M



DAVCO 234035M251 Biodiesel WIF, 25 micron filter element-FS19785, fluid heater, and 24V DC w/thermostat Fuel flows up to 60 gph (230 lph)

Overall Height: 15.50 (394)
Inlet Connection: M16 X 1.5-6G EXT
Outlet Connection:M16 X 1.5-6G EXT
Heater Voltage (DC): 24.00 (24)
WIF Sensor: YES
Width: 6.25 (159)

FH23215



DAVCO 232053RL Diesel Pro Remote mount Medium duty engines, WIF, 12v pre-heater, 10 micron filter element - FS19731 Fuel Flows up to 60 gph (230 lph)

Overall Height: 14.00 (356)
Inlet Connection: 3/8-18 NPTF
Outlet Connection: 3/8-18 NPTF
Heater Voltage (DC): 12.00 (12)
WIF Sensor: YES
Width: 6.25 (159)

FH23216M

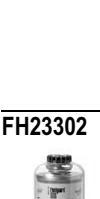

DAVCO 232033RLM25 Diesel Pro Remote mount Medium Duty Engines, WIF, 25 Micron Filter Element FS19785, Fluid Heat, 150W 12V DC Heater

FH23302



DAVCO 233050RL Housing used with FS19624 Uses service part: 3945059S, 3945060S, 3945061S, 3945062S, 3945063S, 3950444S, 3951841S Diesel Pro Remote mount Medium duty engines, unheated Fuel flows up to 90 gph (341 lph)

Overall Height: 15.50 (394)
Inlet Connection: 3/8-18 NPTF
Outlet Connection: 3/8-18 NPTF
Width: 6.25 (159)

FH23303



DAVCO 233052RL Housing used with FS19624 Uses service part: 3945059S, 3945060S, 3945061S, 3945062S, 3945063S, 3950444S, 3951841S Diesel Pro Remote mount Medium duty engines, unheated, w/ 12v pre-heater Fuel flows up to 90 gph (341 lph)

Overall Height: 16.50 (419)
Inlet Connection: 3/8-18 NPTF
Outlet Connection: 3/8-18 NPTF
Heater Voltage (DC): 12.00 (12)
Width: 6.25 (159)

FH23304



DAVCO 233054RL Housing used with FS19624 Uses service part: 3945059S, 3945060S, 3945061S, 3945062S, 3945063S, 3950444S, 3951841S Diesel Pro Remote mount Medium duty engines, unheated w/ 24v pre-heater Fuel flows up to 90 gph (341 lph)

Overall Height: 16.50 (419)
Inlet Connection: 3/8-18 NPTF
Outlet Connection: 3/8-18 NPTF
Heater Voltage (DC): 24.00 (24)
Width: 6.25 (159)

FH23308



DAVCO 233051RL25 Housing used with FS19728 Uses service part: 3950444S, 3951841S Diesel Pro Remote mount Medium duty engines, unheated, WIF, 25 Micron Elemax Filter FS19728Fuel flows 90 gph (341 lph)

Overall Height: 15.50 (394)
Inlet Connection: 3/8-18 NPTF
Outlet Connection: 3/8-18 NPTF
WIF Sensor: YES
Width: 6.25 (159)

FH23315M



DAVCO 233051RLM25 Uses service part: 3950444S Diesel Pro Remote mount Medium duty engines, WIF, 25 micron filter element-FS19785, and plugged ports available for heater/thermostat. Fuel flows up to 90 gph (341 gph)

Overall Height: 15.50 (394)
Inlet Connection: M16 X 1.5-6G EXT
Outlet Connection:M16 X 1.5-6G EXT
WIF Sensor: YES
Width: 6.25 (159)

FH23316M



DAVCO 233055RLM25 Uses service part: 3950444S FH233 Series w/WIF, 25 micron filter element-FS19785, and 24 V DC heater w/thermostat.

Overall Height: 15.50 (394)
Inlet Connection: M16 X 1.5-6G EXT
Outlet Connection:M16 X 1.5-6G EXT
Heater Voltage (DC): 24.00 (24)
WIF Sensor: YES
Width: 6.25 (159)

FH23317M



DAVCO 233035RLM25 Uses service part: 3950444S Diesel Pro Remote mount Medium duty engines, WIF, 25 micron filter element-FS19785, fluid heat w/ 24v pre-heater w/thermostat. Fuel flows up to 90 gph (341 lph)

Overall Height: 15.50 (394)
Inlet Connection: M16 X 1.5-6G EXT
Outlet Connection:M16 X 1.5-6G EXT
Heater Voltage (DC): 24.00 (24)
WIF Sensor: YES
Width: 6.25 (159)

E. PRODUCT GUIDE

FH23318M



DAVCO 234051M25 Biodiesel Medium duty engines, WIF, 25 micron filter element-FS19785, plugged ports available for heater/thermostat. Fuel flows up to 90 gph (341 lph)

Overall Height: 15.50 (394)
Inlet Connection: M16 X 1.5-6G EXT
Outlet Connection: M16 X 1.5-6G EXT
WIF Sensor: YES
Width: 6.25 (159)

FH23319M



DAVCO 234055M25 Biodiesel Medium duty engines, WIF, 25 micron filter element-FS19785, 24v pre-heater w/thermostat. Fuel flows up to 90 gph (341 lph)

Overall Height: 15.50 (394)
Inlet Connection: M16 X 1.5-6G EXT
Outlet Connection: M16 X 1.5-6G EXT
Heater Voltage (DC): 24.00 (24)
WIF Sensor: YES
Width: 6.25 (159)

FH23320M



DAVCO 234035M25 Biodiesel Medium duty engines, WIF, 25 micron filter element-FS19785, fluid heat w/ 24v pre-heater w/thermostat. Fuel flows up to 90 gph (341 lph)

Overall Height: 15.50 (394)
Inlet Connection: M16 X 1.5-6G EXT
Outlet Connection: M16 X 1.5-6G EXT
Heater Voltage (DC): 24.00 (24)
WIF Sensor: YES
Width: 6.25 (159)

FH23321

DAVCO 233051RL10 Uses service part: 3950444S Diesel Pro Remote mount Medium duty engines, unheated, WIF, 10 micron element-FS19727. Fuel flows up to 90 gph (341 lph)

Overall Height: 15.50 (394)
Inlet Connection: 3/8-18 NPTF
Outlet Connection: 3/8-18 NPTF
WIF Sensor: YES
Width: 6.25 (159)

FH23322M

DAVCO 233055RFLGDM251

Overall Height: 15.50 (394)
Inlet Connection: M16 X 1.5-6G EXT
Outlet Connection: M16 X 1.5-6G EXT
Heater Voltage (DC): 24.00 (24)
WIF Sensor: YES
Width: 6.25 (159)

FH23400



DAVCO 910050AMB Uses service part: 3950445S Industrial Pro Heavy duty engines, Drain, unheated, 7micron filter element FS19763 Fuel flows up to 200 gph (757 lph)

Overall Height: 19.01 (483)
Inlet Connection: 3/4-14 NPTF
Outlet Connection: 3/4-14 NPTF
Width: 6.30 (160)

FH23401



DAVCO 910054AMB Uses service part: 3950445S Industrial Pro Heavy duty engines, Drain, Fluid Heat with 24V Pre-Heater, 7micron filter element FS19763 Fuel flows up to 200 gph (757 lph)

FH23402



DAVCO 910052AMB Uses service part: 3950445S Industrial Pro Heavy duty engines, Drain, Fluid Heat with 12V Pre-Heater, 7 micron filter element FS19763 Fuel flows up to 200 gph (757 lph)

FH23411



DAVCO 390618 Housing used with FS19804 Single Sea Pro 6, 10u Spin-on, No WIF (probe), w/plugged WIF port, drain Fuel flows up to 200 gph (757 lph)

Overall Height: 27.09 (688)
Inlet Connection: 3/4-14 NPT
Outlet Connection: 3/4-14 NPT
Width: 9.00 (229)

FH23412



DAVCO 390636 Housing used with FS19804 Dual Sea Pro 6, 10u Spin-on, no WIF (probe), w/plugged WIF ports, drain Fuel flows up to 400 gph (1515 lph)

Overall Height: 27.02 (686)
Inlet Connection: 1-11 1/2 NPT
Outlet Connection: 1-11 1/2 NPT
Width: 19.00 (483)

FH23413



DAVCO 390654 Housing used with FS19804 Triple Sea Pro 6, 10u Spin-on, No WIF (probe), w/plugged WIF ports, drain Fuel flows up to 600 gph (2272 lph)

Overall Height: 26.67 (677)
Inlet Connection: 1-11 1/2 NPT
Outlet Connection: 1-11 1/2 NPT
Width: 29.00 (737)

FH23414



DAVCO 39061802 Housing used with FS19804 Single Sea Pro 6, 10u Spin-on, WIF(Probe), drain Fuel flows up to 200 gph (757 lph)

Overall Height: 27.09 (688)
Inlet Connection: 3/4-14 NPT
Outlet Connection: 3/4-14 NPT
Width: 9.00 (229)

FH23417



DAVCO 39063604 Housing used with FS19804 Duplex Sea Pro 6, 10u Spin-on, No WIF (Probe), w/plugged WIF ports, drain, 4-way valve Fuel flows up to 400 gph (1515 lph)

Overall Height: 27.06 (687)
Inlet Connection: 1-11 1/2 NPT
Outlet Connection: 1-11 1/2 NPT
Width: 19.00 (483)

FH23418



DAVCO 39065404 Housing used with FS19804 Triplex Sea Pro 6, 10u Spin-on, No WIF (Probe), w/plugged WIF ports, drain, 4-way valve Fuel flows up to 600 gph (2272 lph)

Overall Height: 26.67 (677)
Inlet Connection: 1-11 1/2 NPT
Outlet Connection: 1-11 1/2 NPT
Width: 29.00 (737)

FH23419



DAVCO 390718 Single Sea Pro 7, 7u Plus Size EleMax, No WIF, w/plugged WIF ports, drain Fuel flows up to 200 gph (757 lph)

Overall Height: 24.57 (624)
Inlet Connection: 3/4-14 NPT
Outlet Connection: 3/4-14 NPT
Width: 9.00 (229)

FH23420



DAVCO 390736 Dual Sea Pro 7, 7u Plus Size EleMax, No WIF, w/plugged WIF port, drain Fuel flows up to 400 gph (1515 lph)

Overall Height: 24.13 (613)
Inlet Connection: 1-11 1/2 NPT
Outlet Connection: 1-11 1/2 NPT
Width: 19.00 (483)

FH23421

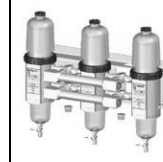

DAVCO 390754 Triple Sea Pro 7, 7u Plus Size EleMax, No WIF, w/plugged WIF ports, drain Fuel flows up to 600 gph (2272 lph)

Overall Height: 24.16 (614)
Inlet Connection: 1-11 1/2 NPT
Outlet Connection: 1-11 1/2 NPT
Width: 29.00 (737)

FH23422



DAVCO 39071802 Single Sea Pro 7, 7u Plus Size EleMax, WIF (Probe), drain Fuel flows up to 200 gph (757 lph)

Overall Height: 24.57 (624)
Inlet Connection: 3/4-14 NPT
Outlet Connection: 3/4-14 NPT
Width: 9.00 (229)

FH23425



DAVCO 39073604 Duplex SeaPro 7, 7u Plus Size EleMax, No WIF (Probe), w/plugged WIF ports, drain, 4-way valve Fuel flows up to 400 gph (1515 lph)

Overall Height: 24.13 (613)
Inlet Connection: 1-11 1/2 NPT
Outlet Connection: 1-11 1/2 NPT
Width: 19.00 (483)



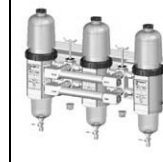









FH23426



DAVCO 39075404 Triplex Sea Pro 7, 7u Plus Size EleMax, No WIF (Probe), w/plugged WIF port, drain, 4-way valve Fuel flows up to 600 gph (2272 lph)

Overall Height: 24.16 (614)
Inlet Connection: 1-11 1/2 NPT
Outlet Connection: 1-11 1/2 NPT
Width: 29.00 (737)

E. PRODUCT GUIDE

<p>FH23435</p>  <p>DAVCO 92005002AMB Housing used with FS19765 Uses service part: 3950445S Dual Industrial Pro Heavy duty off-hwy engines, unheated, drain, Tee connector Fuel flows up to 400 gph (1515 lph)</p>	<p>FH23448</p>  <p>DAVCO 3907180225 Housing used with FS19765 Single Sea Pro 7 with Drain and WIF Fuel flows up to 200 gph (757 lph)</p> <p>Overall Height: 24.57 (624) Inlet Connection: 3/4-14 NPT Outlet Connection: 3/4-14 NPT Width: 9.00 (229)</p>	<p>FH23460</p> <p>CUMMINS 4966991, DAVCO 3915550 Housing used with FS19841 Single Sea Pro 5, 10u, WIF, Fuel flows up to 180 gph</p> <p>Overall Height: 22.27 (566) Inlet Connection: SAE #8, 37 DEGREE FLARE Outlet Connection: SAE #8, 37 DEGREE FLARE WIF Sensor: YES Pressure Diagnosis Port: YES Width: 11.98 (304)</p>
<p>FH23438</p>  <p>DAVCO 92006002AMB Uses service part: 3950445S Triplex Industrial Pro Heavy Duty Off-Hwy Engines, unheated, 4-way valve Fuel Flows up to 600 gph (2272 lph)</p> <p>Overall Height: 19.01 (483) Inlet Connection: 1 NPT Outlet Connection: 1 NPT Width: 29.00 (737)</p>	<p>FH23453</p>  <p>DAVCO 91005402AMB Housing used with FS19765 Uses service part: 3950445S Industrial Pro Heavy duty off-hwy engines 500 hp & up, fluid Heat w/ 24V Pre-Heater</p> <p>Overall Height: 19.01 (483) Inlet Connection: 3/4-14 NPTF Outlet Connection: 3/4-14 NPTF Heater Voltage (DC): 24.00 (24) Width: 6.30 (160)</p>	<p>FH23461</p> <p>DAVCO 392540, CUMMINS 4968541 Housing used with FS19841 Dual Sea Pro 5, 10u, WIF, Fuel Flows up to 360 gph</p> <p>Overall Height: 22.27 (566) Inlet Connection: SAE #12, 37 DEGREE FLARE Outlet Connection: SAE #12, 37 DEGREE FLARE WIF Sensor: YES Pressure Diagnosis Port: YES Width: 35.36 (898)</p>
<p>FH23439</p>  <p>DAVCO 920050 Uses service part: 3950445S Dual Industrial Pro Heavy Duty Off-Hwy Engines, unheated, Tee connector Fuel Flows up to 400gph (1515 lph)</p> <p>Overall Height: 19.01 (483) Inlet Connection: 1-11 1/2 NPT Outlet Connection: 1-11 1/2 NPT Width: 18.75 (476)</p>	<p>FH23457</p>  <p>DAVCO 9100500207, CUMMINS 4964097 Single Industrial Pro with Primer Pump and By-Pass valve assembly. Unheated, WIF, Drain Valve Fuel Flows up to 200 gph (757 lph)</p> <p>Overall Height: 18.81 (478) Inlet Connection: 3/4-14 NPTF Outlet Connection: 3/4-14 NPTF WIF Sensor: YES Pressure Diagnosis Port: YES Width: 12.15 (309)</p>	<p>FH23462</p> <p>DAVCO 393540, CUMMINS 4968542 Housing used with FS19841 Triple Sea Pro 5, 10u, WIF, Fuel Flows up to 540 gph</p> <p>Overall Height: 22.27 (566) Inlet Connection: SAE #12, 37 DEGREE FLARE Outlet Connection: SAE #12, 37 DEGREE FLARE WIF Sensor: YES Pressure Diagnosis Port: YES Width: 31.37 (797)</p>
<p>FH23440</p>  <p>DAVCO 92005004AMB Uses service part: 3950445S Duplex Industrial Pro Remote Mount FWS, Unheated with a 4-way valve. Heavy Duty Off-Hwy Engines, Fuel Flows up to 400 gph.</p> <p>Overall Height: 19.01 (483) Inlet Connection: 1 NPT Outlet Connection: 1 NPT Width: 18.75 (476)</p>	<p>FH23458</p>  <p>DAVCO 9200400207, CUMMINS 4964098 Dual Industrial Pro with Primer Pump and By-Pass valve assembly Heavy duty off-hwy engines, unheated, WIF, Drain Valve, Tee Connector Fuel Flows up to 400 gph (1515 lph)</p> <p>Overall Height: 18.58 (472) Inlet Connection: 1 1/4-11 1/2 NPT Outlet Connection: 1 1/4-11 1/2 NPT WIF Sensor: YES Pressure Diagnosis Port: YES Width: 25.25 (641)</p>	<p>FH23463</p> <p>CUMMINS 4968775, DAVCO 392560 Housing used with FS19841 Duplex Sea Pro 5, 10u, without priming pump, 4-way connection, Fuel flows up to 360gph</p> <p>Overall Height: 22.27 (566) Inlet Connection: SAE #12, 37 DEGREE FLARE Outlet Connection: SAE #12, 37 DEGREE FLARE WIF Sensor: YES Pressure Diagnosis Port: YES Width: 25.36 (644)</p>
<p>FH23441</p>  <p>DAVCO 920060AMB Uses service part: 3950445S Triplex Industrial Pro Heavy Duty Off-Hwy Engines, unheated, Tee connector Fuel Flows up to 600gph (2272 lph)</p> <p>Overall Height: 19.01 (483) Inlet Connection: 1-11 1/2 NPT Outlet Connection: 1-11 1/2 NPT Width: 29.00 (737)</p>	<p>FH23459</p>  <p>DAVCO 9300400207, CUMMINS 4964099 Triple Industrial Pro with Primer Pump and By-Pass valve assembly Heavy duty off-hwy engines, unheated, WIF, Drain Valve, Two Tee Connectors Fuel Flows up to 600 gph (2272 lph)</p> <p>Overall Height: 18.58 (472) Inlet Connection: 1 1/4-11 1/2 NPT Outlet Connection: 1 1/4-11 1/2 NPT WIF Sensor: YES Pressure Diagnosis Port: YES Width: 30.69 (780)</p>	<p>FH23464</p> <p>DAVCO 39356002CEG07, CUMMINS 4970232 Housing used with FS19841 Triplex Sea Pro 5, 7u, No WIF, Fuel Flows up to 540 gph</p> <p>Overall Height: 22.27 (566) Inlet Connection: SAE #12, 37 DEGREE FLARE Outlet Connection: SAE #12, 37 DEGREE FLARE Pressure Diagnosis Port: YES Width: 31.45 (799)</p>
<p>FH23446</p>  <p>DAVCO 3906180225 Housing used with FS19804 Single Sea Pro 6 with Drain and WIF Fuel flows up to 220 gph (757 lph)</p> <p>Overall Height: 27.09 (688) Inlet Connection: 3/4-14 NPT Outlet Connection: 3/4-14 NPT Width: 9.00 (229)</p>		<p>FH23465</p> <p>CUMMINS 4970231 Duplex Sea Pro 5, with pump</p>
<p>FH23447</p>  <p>DAVCO 39071825 Housing used with FS19765 Single Sea Pro 7 with Drain Fuel flows up to 200 gph (757 lph)</p> <p>Overall Height: 24.57 (624) Inlet Connection: 3/4-14 NPT Outlet Connection: 3/4-14 NPT Width: 9.00 (229)</p>		

E. PRODUCT GUIDE

FH23466



DAVCO 91015002CEG07, CUMMINS 4967838 Housing used with FS19763 Single Industrial Pro with Pump for Terex Applications. Fuel flows up to 200 gph (757 lph)

Overall Height: 18.81 (478)
Inlet Connection: 3/4-14 NPTF
Outlet Connection: 3/4-14 NPTF
WIF Sensor: YES
Pressure Diagnosis Port: YES
Width: 12.15 (309)

FH23467

Industrial Pro Duplex Unit with Priming Pump Assembly

Overall Height: 18.81 (478)
Inlet Connection: 1 1/4-11 1/2 NPT
Outlet Connection: 1 1/4-11 1/2 NPT
WIF Sensor: YES
Pressure Diagnosis Port: YES
Width: 25.25 (641)

FH23468

Industrial Pro Triplex Unit with Priming Pump Assembly

Overall Height: 18.81 (478)
Inlet Connection: 1 1/4-11 1/2 NPT
Outlet Connection: 1 1/4-11 1/2 NPT
WIF Sensor: YES
Pressure Diagnosis Port: YES
Width: 30.69 (780)

FH23469

DAVCO 39254102CEGS07 Housing used with FS19841 Dual Sea Pro 5, WIF, DP Gauge, Fuel flows up to 400 gph (1514 lph)

Overall Height: 22.27 (566)
Inlet Connection: 1 1/4-11 1/2 NPT
Outlet Connection: 1 1/4-11 1/2 NPT
WIF Sensor: YES
Pressure Diagnosis Port: YES
Width: 35.36 (898)

FH23470

DAVCO 39354102CEGS07 Housing used with FS19841 Triple Sea Pro 5, WIF, DP Gauge, Fuel flows up to 600 gph (2271 lph)

Overall Height: 22.27 (566)
Inlet Connection: 1 1/4-11 1/2 NPT
Outlet Connection: 1 1/4-11 1/2 NPT
WIF Sensor: YES
Pressure Diagnosis Port: YES
Width: 31.37 (797)

FH23471

DAVCO 39356102CEGS07 Housing used with FS19841 Triplex Sea Pro 5, WIF, Priming Pump, Fuel flows up to 600 gph (2271 lph)

Overall Height: 22.27 (566)
Inlet Connection: SAE #12, 37 DEGREE FLARE
Outlet Connection: SAE #12, 37 DEGREE FLARE
Pressure Diagnosis Port: YES
Width: 31.45 (799)

FH23472

DAVCO 39256102CEGS07 Housing used with FS19841 Duplex Sea Pro 5, WIF, DP Gauge, Fuel flows up to 400 gph (1514 lph)

Overall Height: 22.27 (566)
Inlet Connection: SAE #12, 37 DEGREE FLARE
Outlet Connection: SAE #12, 37 DEGREE FLARE
Width: 25.36 (644)

FH23473

DAVCO 39155102CEGS07 Housing used with FS19841 Single Sea Pro 5, WIF, Fuel flows up to 200 gph (757 lph)

Overall Height: 22.27 (566)
Inlet Connection: 3/4-14 NPTF
Outlet Connection: 3/4-14 NPTF
WIF Sensor: YES
Pressure Diagnosis Port: YES
Width: 11.98 (304)

FH23474

Sea Pro 7 Single, WIF, with FS19764 element.

Overall Height: 24.57 (624)
Inlet Connection: 3/4-14 NPT
Outlet Connection: 3/4-14 NPT
WIF Sensor: YES
Width: 9.00 (229)

FH23475

Sea Pro 7 Duplex, WIF, with FS19764 element.

Overall Height: 24.13 (613)
Inlet Connection: 1-11 1/2 NPT
Outlet Connection: 1-11 1/2 NPT
WIF Sensor: YES
Width: 19.00 (483)

FH23476

Sea Pro 7 Triplex, WIF, with FS19764 element.

Overall Height: 24.16 (614)
Inlet Connection: 1-11 1/2 NPT
Outlet Connection: 1-11 1/2 NPT
WIF Sensor: YES
Width: 29.00 (737)

Fuel/Water Separators

FS1000



CUMMINS 3329289, TEREX 15271319 Filter used with 142784S, 3930618S, 3962018S For Marine applications use FS1009 Is a longer version of FS1001 Uses service part: 255622S Upgrade of FS1212 Required on all Cummins Select and Quantum 19L Engines (Stratapore)

Overall Height: 9.81 (249)
Largest OD: 3.67 (93)
Standpipe: YES
Thread Size: 1-14 UNS-2B

FS1001



CUMMINS 3413084 Is a short version of FS1000 Uses service part: 255622S

Overall Height: 7.98 (203)
Largest OD: 3.68 (93)
Standpipe: YES
Thread Size: 1-14 UNS-2B

FS1003



CUMMINS 3406889 For Upgrade, use FS19596

Gasket: 3313108, 3911818, 3933325, 3943730
Overall Height: 9.77 (248)
Largest OD: 3.69 (94)
Standpipe: YES
Thread Size: 1-14 UNS-2B

FS1006



CUMMINS 3089916, KOMATSU 6003113110, KOMATSU 6003117550, CUMMINS 4095189, KOMATSU 6003113111 Filter used with 3302367S Upgrade of FF5693, FS1216 Recommended for Cummins V28, KV38, and KV50 engines

Overall Height: 12.32 (313)
Largest OD: 4.74 (120)
Standpipe: YES
Thread Size: 1 1/4-12 UNS-2B

FS1007



CUMMINS 3101871 Uses service part: 3894794S, 3911940S Upgrade of FS1040 MAXIMUM ENGINE PROTECTION Suction Side Fuel with Combination WIF Sensor and drain valve.

Gasket: 3894794 (1)
Overall Height: 11.57 (294)
Largest OD: 4.68 (119)
Thread Size: M85 X 2-7H INT

FS1008



DAVCO 321 Replacement element for Davco remote mounted Fuel Water Separator system Must be mounted upside down to drain the water.

Overall Height: 6.22 (158)
Largest OD: 3.70 (94)
Thread Size: 1-14 UNS-2B

FS1009



CUMMINS 3331673 For non-Marine applications, use FS1000

Gasket: 333849 (1)
Overall Height: 9.37 (238)
Largest OD: 3.67 (93)
Standpipe: YES
Thread Size: 1-14 UNS-2B

FS1011

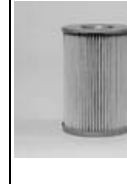

LUBERFINER 1723787 For Upgrade, use FS1020 Replacement Element for Optiguard Fuel Conditioning System

Gasket: 3904554
Overall Height: 6.47 (164)
End 1 OD: 4.31 (109)
End 2 OD: 4.29 (109)
End 1 ID: 1.07 (27)

FS1013



CUMMINS 4095190 Fuel/Water Separator for Marine engines K35 and K50 Same as FS1006 except with metal drain valve.

Overall Height: 11.93 (303)
Largest OD: 4.74 (120)
Standpipe: YES
Thread Size: 1 1/4-12UNS-2B

E. PRODUCT GUIDE

FS1015 Uses service part: 3831871S Upgrade of FS1242 Optional Fuel Element w/Stratapore Media



Overall Height: 7.52 (191)
Largest OD: 3.66 (93)
Thread Size: 1-14 UNS-2B

FS1015B Upgrade of FS1242, FS1242B FS1015 and Bowl Assembly



Overall Height: 9.80 (249)
Largest OD: 3.92 (100)
Thread Size: 1-14 UNS-2B

FS1020 Upgrade of FS1011 Replacement Element for Optiguard Fuel Conditioning System



Overall Height: 6.47 (164)
Overall OD: 4.62 (117)
End 1 ID: 0.65 (17)

FS1022 CUMMINS 3800394 Filter used with 3962018S Uses service part: 3953517S Cummins ISC engine Includes WIF sensor port



Overall Height: 9.39 (238)
Largest OD: 3.69 (94)
Standpipe: YES
Thread Size: 1-14 UNS-2B

FS1023 CIM-TEK 70804 100 micron mesh wire screen



Overall Height: 7.49 (190)
Largest OD: 3.69 (94)
Thread Size: 1-14 UNS-2B

FS1029W Uses service part: 3912384S Upgrade of FF5369W For Upgrade, use FS19727 Davco replacement cartridge including service gaskets.



Gasket: 3901455 (1), 3901456(1), 3926140
Overall Height: 7.03 (179)
Overall OD: 3.82 (97)
End 1 ID: 0.66 (17)

FS1040 CUMMINS 3101872 Uses service part: 3911940S For Upgrade, use FS1007 Heavy Duty Protection with Optimum Life Suction Side Fuel with Combination WIF Sensor and drain valve.



Overall Height: 11.57 (294)
Largest OD: 4.68 (119)
Thread Size: M85 X 2-7H INT

FS1041 CUMMINS 3104081



Overall Height: 11.57 (294)
Largest OD: 4.68 (119)
Thread Size: M85 X 2-7H INT

FS1054 FUEL PREPARATOR FF135A



Overall Height: 9.98 (253)
Largest OD: 3.72 (94)
Thread Size: 1 1/2-16 UN-2B

FS1062 CUMMINS 4924640 Stage 1 Filter for the Dual and Triple Heads for HHP- suction side application.



Overall Height: 11.57 (294)
Largest OD: 4.68 (119)
Thread Size: M85 X 2-7H INT

FS1065 CUMMINS 4934879 Cummins ISC07



Overall Height: 9.79 (249)
Largest OD: 3.69 (94)
Standpipe: YES
Thread Size: 1-14 UNS-2B

FS1201 Filter used with 256172S, 256546S Uses service part: 251390S For Upgrade, use FS19553 5-TON Army truck with Cummins engine, all diesels including marine applications



Gasket: 251390
Overall Height: 8.67 (220)
Overall OD: 5.83 (148)
End 1 ID: 0.99 (25)

FS1202 FRAM CC1133PL Coalescer Cartridge Separator Cartridge FS1203



Gasket: 3310776, 3310777
Overall Height: 7.75 (197)
Overall OD: 3.01 (76)
End 1 ID: 1.04 (26)

FS1203 FRAM CS1133PL Separator Cartridge Coalescer Cartridge FS1202



Gasket: 3310776, 3310777
Overall Height: 4.81 (122)
Overall OD: 3.01 (76)
End 1 ID: 1.04 (26)

FS1204 PERMA-COOL B1000



Overall Height: 6.24 (159)
Largest OD: 3.69 (94)
Thread Size: 1-14 UNS-2B

FS1205 CATERPILLAR 8N9803



Height: 3.31 (84)
Length: 4.96 (126)
Width: 3.71 (94)

FS1206 KOMATSU 303173 For Upgrade, use FS1293



Gasket: 3316758, 3837452, 3837453
Overall Height: 9.65 (245)
Overall OD: 4.29 (109)
End 1 ID: 0.65 (17)
End 2 ID: 0.83 (21)

FS1207 RACOR 2040TM For Upgrade, use FS1294



Gasket: 3316758, 3837452, 3837453
Overall Height: 4.69 (119)
Overall OD: 4.29 (109)
End 1 ID: 0.65 (17)
End 2 ID: 0.83 (21)

FS1209 GMC 14075347

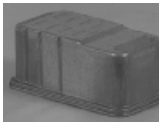

Inlet Connection: .3 HOSE
Outlet Connection: .3 HOSE
Height: 2.64 (67)
Length: 6.31 (160)
Width: 3.28 (83)

FS1210 MOTORCRAFT FD261 Two gaskets included.



Overall Height: 2.84 (72)
Overall OD: 1.75 (44)
End 1 ID: 0.49 (12)

FS1212 CUMMINS 3308638, INGERSOLL-RAND 57138554, VOLVO 36849 Filter used with 142784S, 212013S, 3930618S Is a longer version of FS1282 Uses service part: 255622S Upgrade of FF105 For Upgrade, use FS1242B, FS1000 Replaces FF104, FF105, FF105C, FF105D, and FF213 Optional upgrade is FS1242B



Gasket: 255622
Overall Height: 7.53 (191)
Largest OD: 3.69 (94)
Thread Size: 1-14 UNS-2B

FS1214 Upgrade of FF185 Caterpillar























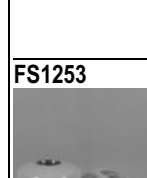

Overall Height: 7.98 (203)
Largest OD: 3.68 (93)
Thread Size: 1-14 UNS-2B

FS1216 CUMMINS 3309437 Filter used with 3302367S Upgrade of FF202 For Upgrade, use FS1006



Overall Height: 12.37 (314)
Largest OD: 4.67 (119)
Thread Size: 1 1/4-12 UNS-2B







E. PRODUCT GUIDE







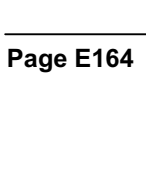

<p>FS1218 Upgrade of FF211 Caterpillar</p>  <p>Overall Height: 11.48 (292) Largest OD: 4.27 (108) Thread Size: 1-14 UNS-2B</p>	<p>FS1233 RACOR R24S Uses service part: 3831871S Flow Is Inside/Out Bowl not included</p>  <p>Gasket: 3834623, 3834624 Overall Height: 3.52 (89) Largest OD: 3.75 (95) Thread Size: 1-14 UNS-2B</p>	<p>FS1242B RACOR B32001, CUMMINS 3355904, RACOR S3201 Uses service part: 3309490S, 3834217S, 3836029AS Upgrade of FS1212 For Upgrade, use FS1015B FS1242 and Bowl assembly</p>  <p>Overall Height: 9.09 (231) Largest OD: 3.92 (100) Thread Size: 1-14 UNS-2B</p>
<p>FS1219 MACK 483GB433B Upgrade of FF172</p>  <p>Overall Height: 9.15 (232) Largest OD: 4.27 (108) Thread Size: 13/16-18 UNS-2B</p>	<p>FS1234 RACOR R26S Uses service part: 3831871S Flow Is Inside/Out Bowl Not Included. For assembly with bowl, Use FS1234B.</p>  <p>Gasket: 3834623, 3834624 Overall Height: 4.66 (118) Largest OD: 3.75 (95) Thread Size: 1-14 UNS-2B</p>	<p>FS1247 FORD E7HZ9N184A</p>  <p>Gasket: 3834623, 3834624 Overall Height: 4.66 (118) Largest OD: 3.75 (95) Thread Size: 1-14 UNS-2B</p>
<p>FS1220 Upgrade of FF196 Case/International</p>  <p>Overall Height: 6.46 (164) Largest OD: 3.69 (94) Thread Size: 1-14 UNS-2B</p>	<p>FS1235 CASE J911213 Filter used with 3311505S Is a short version of FS1251</p>  <p>Overall Height: 4.53 (115) Largest OD: 3.03 (77) Thread Size: M16 X 1.5-6H INT</p>	<p>FS1251 CUMMINS 3843760, CUMMINS 3286503 Filter used with 3311505S Is a longer version of FS1235 Upgrade of FF5052</p>  <p>Gasket: 3311919 (1) Overall Height: 5.63 (143) Largest OD: 3.02 (77) Standpipe: YES Thread Size: M16 X 1.5-6H INT</p>
<p>FS1221 Filter used with 3311505S Upgrade of FF5018 Bosch</p>  <p>Overall Height: 7.09 (180) Largest OD: 3.03 (77) Thread Size: M16 X 1.5-6H INT</p>	<p>FS1240 Uses service part: 3831871S Outside/In Flow Version of FS1233 Must be used with Fleetguard head. Bowl not included</p>  <p>Overall Height: 3.86 (98) Largest OD: 3.66 (93) Thread Size: 1-14 UNS-2B</p>	<p>FS1253 CHRYSLER 4741689, CUMMINS 3923108 Uses service part: 3831852S For Upgrade, use FS19519</p>  <p>Overall Height: 4.48 (114) Largest OD: 3.69 (94) Thread Size: M20 X 1.5-6H INT</p>
<p>FS1225 Upgrade of FF5020 Case/International</p>  <p>Overall Height: 7.94 (202) Largest OD: 3.69 (94) Thread Size: 1-14 UNS-2B</p>	<p>FS1240B FS1240 and Bowl Assembly</p>  <p>Overall Height: 6.06 (154) Largest OD: 3.66 (93) Thread Size: 1-14 UNS-2B</p>	<p>FS1253V CUMMINS 3865402, CHRYSLER 4762032 Uses service part: 3831852S For Upgrade, use FS19519V Filter and valve assembly</p>  <p>Overall Height: 6.63 (168) Largest OD: 3.69 (94) Thread Size: M20 X 1.5-6H INT</p>
<p>FS1231 CASE 1808623C1 Separator version of FF5035, FF5078</p>  <p>Overall Height: 8.98 (228) Largest OD: 4.27 (108) Thread Size: 7/8-13 UNF-28</p>	<p>FS1241 LUBERFINER 1623750 Uses service part: 3831871S Outside/In flow version of FS1234. Must be used with Fleetguard head. Bowl not included</p>  <p>Overall Height: 4.86 (123) Largest OD: 3.66 (93) Thread Size: 1-14 UNS-2B</p>	<p>FS1254 IVECO 1907539</p>  <p>Overall Height: 7.76 (197) Largest OD: 3.68 (94) Thread Size: M14 X 1.5-6H INT</p>
<p>FS1232 Uses service part: 3831852S, 3832054S</p>  <p>Gasket: 3311919, 331231, 3833972 Overall Height: 4.42 (112) Largest OD: 3.05 (77) Thread Size: M16 X 1.5-6H INT</p>	<p>FS1241B FS1241 And Bowl Assembly</p>  <p>Overall Height: 7.06 (179) Largest OD: 3.66 (93) Thread Size: 1-14 UNS-2B</p>	<p>FS1258 CUMMINS 3942961 Uses service part: 3900349S, 3905595S, 3925469S, 3928814S Top load FWS w/ 12volt heater (black); 24volt (blue)</p>  <p>Overall Height: 7.50 (190) Inlet Connection: M12 X 1.5-6H Outlet Connection: M12 X 1.5-6H WIF Sensor: YES Pressure Diagnosis Port: YES Length: 5.43 (138) Width: 6.34 (161)</p>
<p>FS1232V CUMMINS 3912104 Uses service part: 3831852S</p>  <p>Overall Height: 6.69 (170) Largest OD: 3.05 (77) Thread Size: M16 X 1.5-6H</p>	<p>FS1242 Uses service part: 3831871S For Upgrade, use FS1015, FS1015B Element only For Filter/Bowl assembly Version use FS1242B</p>  <p>Overall Height: 6.89 (175) Largest OD: 3.72 (94) Thread Size: 1-14 UNS-2B</p>	



E. PRODUCT GUIDE

<p>FS1259 Top Load Fuel w/ 24volt heater</p>  <p>Overall Height: 7.50 (190) Inlet Connection: M12 X 1.5-6H Outlet Connection: M12 X 1.5-6H WIF Sensor: YES Pressure Diagnosis Port: YES Length: 5.43 (138) Width: 6.34 (161)</p>	<p>FS1282 CUMMINS 3843447 Is a short version of FS1212</p>  <p>Overall Height: 6.42 (163) Largest OD: 3.69 (94) Thread Size: 1-14 UNS-2B</p>	<p>FS1293 Upgrade of FS1206</p>  <p>Gasket: 3316758 (1), 3837452(1), 3837453 (1) Overall Height: 9.65 (245) Overall OD: 4.29 (109) End 1 ID: 0.65 (17) End 2 ID: 0.83 (21)</p>
<p>FS1269 Housing used with FS19855 Uses service part: 3900349S, 3905594S, 3905595S, 3925469S, 3928814S Top load FWS w/o heater</p>  <p>Overall Height: 7.50 (190) Inlet Connection: M12 X 1.5-6H INT Outlet Connection: M12 X 1.5-6H INT WIF Sensor: YES Pressure Diagnosis Port: YES Length: 5.43 (138) Width: 5.76 (146)</p>	<p>FS1283 PARKER HW51125</p>  <p>Overall Height: 10.98 (279) Largest OD: 5.05 (128) Thread Size: 1 1/2-16 UN-2B</p>	<p>FS1294 Upgrade of FS1207</p>  <p>Overall Height: 4.69 (119) Overall OD: 4.29 (109) End 1 ID: 0.65 (17) End 2 ID: 0.83 (21)</p>
<p>FS1276 RENAULT V.I. 7701030546</p>  <p>Overall Height: 7.09 (180) Largest OD: 3.03 (77) Thread Size: M16 X 1.5-6H INT</p>	<p>FS1284 PARKER HW3510</p>  <p>Overall Height: 5.28 (134) Largest OD: 3.69 (94) Thread Size: 1-12 UNF-2B</p>	<p>FS1295 AC TP1256</p>  <p>Overall Height: 5.28 (134) Overall OD: 3.27 (83) End 1 ID: 0.74 (19)</p>
<p>FS1277 CIM-TEK 300M</p>  <p>Overall Height: 5.48 (139) Largest OD: 3.75 (95) Thread Size: 1-12 UNF-2B</p>	<p>FS1285 CIM-TEK 70023 Filter used with HH6951, HH6957, HH6962, HH6967, HH6973 Uses service part: 3929251S Fuel Island applications Gas or Diesel</p>  <p>Overall Height: 10.98 (279) Largest OD: 5.05 (128) Thread Size: 1 1/2-16 UN-2B</p>	<p>FS1298 FORD F4TZ9N184A, CASE 1822631C91</p>  <p>Overall Height: 4.05 (103) Overall OD: 3.27 (83) End 1 ID: 0.61 (15)</p>
<p>FS1279 DAHL 201</p>  <p>Overall Height: 4.50 (114) Overall OD: 6.13 (156) End 1 ID: 3.25 (83) End 2 ID: 1.50 (38)</p>	<p>FS1286 CIM-TEK EHS30 Cim-Tek EHS30 Fuel Island applications</p>  <p>Overall Height: 9.06 (230) Overall OD: 4.79 (122) End 1 ID: 0.53 (13) End 2 ID: 1.07 (27)</p>	<p>FS1299 CUMMINS 3890063</p>  <p>Overall Height: 5.82 (148) Largest OD: 3.69 (94) Thread Size: 13/16-18 UNS-2B</p>
<p>FS1280 CUMMINS 3903410, VOLVO 36846, CUMMINS 3890706, CUMMINS 3930942 Separator version of FF5285 Not for Marine Applications</p>  <p>Gasket: 3311920 (1) Overall Height: 6.49 (165) Largest OD: 3.69 (94) Thread Size: 13/16-18 UNS-2B</p>	<p>FS1287 FORD F1HZ9365A Uses service part: 3948395S</p>  <p>Overall Height: 5.10 (130) Largest OD: 4.36 (111) Thread Size: 1-14 UNS-2B</p>	<p>FS19504 NEW HOLLAND 19305811</p>  <p>Overall Height: 4.53 (115) Largest OD: 3.68 (94) Thread Size: M14 X 1.5-6H INT</p>
<p>FS1281 FORD F2TZ9N184A Separator version of FF5151 Uses service part: 3919147S Bowl Seal Gasket Included</p>  <p>Overall Height: 4.02 (102) Largest OD: 4.35 (110) Thread Size: 1-14 UNS-2B</p>	<p>FS1291 IHC 1685159C91 Uses service part: 3927719S</p>  <p>Overall Height: 6.10 (155) Largest OD: 4.36 (111) Thread Size: 1-14 UNF</p>	<p>FS19511 Filter used with 3912717S, 3914848S, 3920134 Uses service part: 3831871S Cummins midrange engines Clear bowl version w/ drain 3831871S Pre-filter strainer for fuel systems</p>  <p>Overall Height: 3.86 (98) Largest OD: 3.66 (93) Thread Size: 1-12 UNF-2B</p>
<p>FS1282 (repeated entry)</p>  <p>Overall Height: 6.42 (163) Largest OD: 3.69 (94) Thread Size: 1-14 UNS-2B</p>	<p>FS1292 GMC 23512631</p>  <p>Overall Height: 11.77 (299) Largest OD: 5.39 (137) Thread Size: 1 3/8-16 UNS-2B</p>	<p>FS19511B CUMMINS 3092321 Filter used with 3912717S, 3914848S, 3920134 FS19511 and Bowl Assembly</p>  <p>Overall Height: 6.06 (154) Largest OD: 3.66 (93) Thread Size: 1-12 UNF-2B</p>







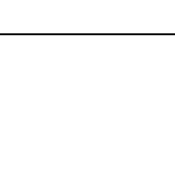

















E. PRODUCT GUIDE

FS19511N 	<p>Filter used with 3954619, 3954621S Uses service part: 3946411S, 3954620S FS19511 and Bowl Assembly for use with M14 WIF Sensors</p> <p>Overall Height: 6.85 (174) Largest OD: 3.66 (93) Thread Size: 1-12 UNF-2B</p>
FS19512 	<p>CUMMINS 3092319 Filter used with 3912717S, 3914848S, 3920134 Pre-filter Strainer for Fuel Systems For Cummins Midrange engines FS19511 - Clear Bowl version w/drain</p> <p>Overall Height: 5.76 (146) Largest OD: 3.72 (94) Thread Size: 1-12 UNF-2B</p>
FS19513 	<p>GMC 23512317 Upgrade of FF5207</p> <p>Overall Height: 9.78 (248) Largest OD: 3.71 (94) Thread Size: 1-12 UNS-2B</p>
FS19516 	<p>JOHN DEERE RE62418 Is a short version of FS19517 Uses service part: 3918985S Final Filter type</p> <p>Overall Height: 5.30 (135) End 1 OD: 3.27 (83) End 2 OD: 2.73 (69) End 1 ID: 0.85 (22)</p>
FS19517 	<p>JOHN DEERE RE62419 Is a longer version of FS19516 Uses service part: 3918985S Final Filter type</p> <p>Overall Height: 6.04 (153) End 1 OD: 3.27 (83) End 2 OD: 2.73 (69) End 1 ID: 0.85 (22)</p>
FS19519 	<p>CUMMINS 3942533, CASE J942533 Uses service part: 3894967S Upgrade of FS1253</p> <p>Gasket: 3833972 Overall Height: 5.75 (146) Largest OD: 3.69 (94) Thread Size: M20 X 1.5-6H INT</p>
FS19519V 	<p>CUMMINS 3894519 Uses service part: 3894967S Upgrade of FS1253V FS19519 w/ valve assembly (WIF)</p> <p>Overall Height: 5.75 (146) Largest OD: 3.69 (94) Thread Size: M20 X 1.5-6H INT</p>
FS19519VP 	<p>FS19519 w/ valve assembly (WIF) carton quantity of 200</p> <p>Overall Height: 5.75 (146) Largest OD: 3.69 (94) Thread Size: M20 X 1.5-6H INT</p>





















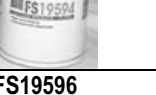



FS19520 	<p>RACOR S3202 GMC 15618921 (Includes gasket for bowl, thread seal gasket)</p> <p>Overall Height: 7.40 (188) Overall OD: 3.62 (92) End 1 ID: 0.99 (25)</p>
FS19521 	<p>RACOR S3225P (Includes two gaskets)</p> <p>Overall Height: 5.04 (128) Overall OD: 4.36 (111) End 1 ID: 0.99 (25) End 2 ID: 0.99 (25) Thread Size: 1-14 UNS-2B</p>
FS19525 	<p>NEW HOLLAND 87840590 Uses service part: 3918985S Final Filter Type</p> <p>Overall Height: 7.47 (190) End 1 OD: 3.27 (83) End 2 OD: 2.73 (69) End 1 ID: 0.85 (22)</p>
FS19526 	<p>NEW HOLLAND 87840591 Uses service part: 3918985S Pre-filter type</p> <p>Overall Height: 5.77 (147) Largest OD: 3.27 (83)</p>
FS19527 	<p>SCANIA 1350734</p> <p>Overall Height: 6.65 (169) Largest OD: 3.68 (94) Thread Size: M24 X 1.5-6H INT</p>
FS19530 	<p>PERKINS 26560145, HEDEN 79800039, STANADYNE 32919 Uses service part: 3918985S Pre-Filter type</p> <p>Overall Height: 5.02 (128) End 1 OD: 3.27 (83) End 2 OD: 2.73 (69) End 1 ID: 0.85 (22)</p>
FS19531 	<p>PERKINS 26560143, CATERPILLAR 1596102, HEDEN 79800038, STANADYNE 32917, CATERPILLAR 1383098 Uses service part: 3918985S Final Filter type</p> <p>Overall Height: 5.77 (147) End 1 OD: 3.27 (83) End 2 OD: 2.73 (69) End 1 ID: 0.85 (22)</p>
FS19532 	<p>RACOR R90P Uses service part: 3948395S</p> <p>Overall Height: 6.10 (155) Largest OD: 4.36 (111) Thread Size: 1-14 UNS 2B</p>

FS19536 	<p>Uses service part: 3912384S Upgrade of FF5369W Includes gasket package</p> <p>Gasket: 3901455, 3901456 Overall Height: 7.03 (179) Overall OD: 3.82 (97) End 1 ID: 0.66 (17)</p>
FS19537 	<p>MACK 483GB472M Separator version of FF5381</p> <p>Overall Height: 9.12 (232) Largest OD: 4.27 (108) Thread Size: M22 X 1.5-6H</p>
FS19538 	<p>RACOR S6464</p> <p>Overall Height: 6.20 (157) Largest OD: 4.36 (111) Thread Size: 1-14 UNS-2B</p>
FS19539 	<p>RACOR 22021</p> <p>Overall Height: 3.15 (80) Largest OD: 3.78 (96) Thread Size: 1-14 UNF-2B</p>
FS19540 	<p>LUBERFINER LFP2000C</p> <p>Overall Height: 11.11 (282) Largest OD: 4.28 (109) Thread Size: 15/16-16 UN-2B</p>
FS19546 	<p>JOHN DEERE RE65431 Pre-Filter Type</p> <p>Overall Height: 7.72 (196) Largest OD: 3.27 (83)</p>
FS19547 	<p>RACOR R43</p> <p>Overall Height: 5.05 (128) Largest OD: 4.36 (111) Thread Size: 1-14 UNF</p>
FS19548 	<p>BALDWIN BF1345SP</p> <p>Overall Height: 6.87 (175) Largest OD: 4.25 (108) Thread Size: 1-14 UNS-2B</p>
FS19550 	<p>Upgrade of FF5392</p> <p>Overall Height: 4.32 (110) End 1 OD: 3.50 (89) End 2 OD: 3.48 (88) End 1 ID: 0.66 (17) End 2 ID: 3.48 (88)</p>

E. PRODUCT GUIDE

FS19551  RACOR R90T Uses service part: 3948395S Package includes beveled top gasket and bowl gasket. Overall Height: 6.10 (155) Largest OD: 4.36 (111) Thread Size: 1-14 UNS 2B	FS19572  LIEBHERR 7381645 Final Filter Type Overall Height: 5.77 (147) Largest OD: 3.27 (83) Standpipe: YES	FS19583  GMC 12554082 Overall Height: 5.94 (151) Largest OD: 3.27 (83)
FS19553  Upgrade of FS1201 For Marine Applications Overall Height: 8.67 (220) Overall OD: 5.83 (148) End 1 ID: 0.10 (3)	FS19573  JOHN DEERE RE60021, INGERSOLL-RAND 85400976 Final Filter type Overall Height: 4.50 (114) Largest OD: 3.27 (83) Standpipe: YES	FS19584  LEYLAND ABRB025 Uses service part: 3928544S Overall Height: 8.61 (219) Largest OD: 3.68 (94) Thread Size: M20 X 1.5-6H INT
FS19554  CATERPILLAR 1311812 Pre-Filter type Overall Height: 5.77 (147) Largest OD: 3.27 (83)	FS19574  JOHN DEERE RE502203 (Bowl attachment has external threads) Overall Height: 8.50 (216) Overall OD: 4.25 (108) End 1 ID: 1.00 (25)	FS19585  MASSEY-FERGUSON 3780931M1 Pre-Filter Type Overall Height: 5.02 (128) End 1 OD: 3.27 (83) End 2 OD: 2.73 (69) End 1 ID: 0.85 (22)
FS19555  CATERPILLAR 1174089 Pre-Filter type Overall Height: 5.77 (147) Largest OD: 3.27 (83)	FS19577  JOHN DEERE RE62424 Pre-Filter type Overall Height: 6.00 (152) End 1 OD: 3.27 (83) End 2 OD: 2.73 (69)	FS19586  CUMMINS 3949344, CUMMINS 3937718 Uses service part: 3900349S, 3925469S, 3928814S Overall Height: 9.12 (232) Inlet Connection: M12 X 1.5-6H Outlet Connection: M12 X 1.5-6H WIF Sensor: YES Length: 5.93 (150) Width: 6.16 (156)
FS19556  Overall Height: 8.67 (220) Overall OD: 5.83 (148) End 1 ID: 0.10 (3)	FS19578  RACOR B32006 Overall Height: 11.75 (298) Largest OD: 4.25 (108) Thread Size: 1-14 UNS-2B	FS19588  STANADYNE 34981, NEW HOLLAND 87801341, NEW HOLLAND 87802332 Pre-Filter Type Overall Height: 5.77 (147) End 1 OD: 3.27 (83) End 2 OD: 2.73 (69) End 1 ID: 0.85 (22)
FS19557  Upgrade of FS19559, FS19762 Maximum Engine Protection Overall Height: 6.47 (164) Overall OD: 4.62 (117) End 1 ID: 0.65 (17)	FS19580  THERMO-KING 118047, JAT 2583 Overall Height: 6.42 (163) Largest OD: 3.69 (94) Thread Size: M22 X 1.5-6H INT	FS19589  LIEBHERR 7381877, STANADYNE 31387 Pre-Filter Type Overall Height: 5.77 (147) End 1 OD: 3.27 (83) End 2 OD: 2.73 (69) End 1 ID: 0.85 (22)
FS19558  Same as FS19536 without paper outerwrap. Overall Height: 7.03 (179) Overall OD: 3.82 (97) End 1 ID: 0.66 (17)	FS19580A  THERMO-KING 118047 For European market only Overall Height: 5.28 (134) Largest OD: 3.70 (94) Thread Size: M22 X 1.5-6H INT	FS19590  CATERPILLAR 1290373 Overall Height: 8.50 (216) End 1 OD: 4.37 (111) End 2 OD: 4.25 (108) Thread Size: 1-14 UNF-2B
FS19559  Upgrade of FS19762 For Upgrade, use FS19557 Heavy Duty Protection with Optimum Life Overall Height: 6.47 (164) Overall OD: 4.62 (117) End 1 ID: 0.65 (17)	FS19581  BOBCAT 6667352, NEW HOLLAND 86504140 Replaces 85259F, 85259H, 85259J, 85259M, 85259R, 85259T Overall Height: 4.34 (110) Largest OD: 3.03 (77) Thread Size: M16 X 1.5-6H INT	FS19591  CATERPILLAR 1335673 (Bowl attachment has internal threads) Overall Height: 8.50 (216) End 1 OD: 4.37 (111) End 2 OD: 4.25 (108) Thread Size: 1-14 UNF-2B
FS19560  CUMMINS 4899413 Overall Height: 5.43 (138) Largest OD: 3.03 (77) Thread Size: M16 X 1.5-6H INT		

E. PRODUCT GUIDE

FS19592  RACOR S3230P, RACOR S3230FG01 Overall Height: 5.52 (140) Overall OD: 3.78 (96) Thread Size: 1-14 UNF-2B	FS19608  CUMMINS 3991350 Filter used with 3937860 Overall Height: 7.57 (192) Largest OD: 3.69 (94) Thread Size: M20 X 1.5-6H INT	FS19619  PERKINS 26560141 Final filter type Overall Height: 7.67 (195) End 1 OD: 3.27 (83) End 2 OD: 2.73 (69) End 1 ID: 0.85 (22)
FS19593  RACOR S3226P Overall Height: 6.25 (159) Overall OD: 4.25 (108) Thread Size: 1-14 UNF-2B	FS19609  FORD 4032667 Ford Transit Vans - Final Filter type Overall Height: 7.67 (195) Largest OD: 3.27 (83) Standpipe: YES Thread Size: KEY LOCK CONFIGURATION, NO THREA	FS19621  CATERPILLAR 1561200 Caterpillar Excavators 301.5 & 302.5 Overall Height: 5.25 (133) End 1 OD: 3.27 (83) End 2 OD: 2.73 (69) End 1 ID: 0.85 (22)
FS19594  Does not contain provisions for a WIF sensor Overall Height: 5.58 (142) Largest OD: 3.02 (77) Thread Size: 3/4-16 UNF-2B	FS19610  CUMMINS 2830359 Overall Height: 8.61 (219) Largest OD: 3.68 (94) Thread Size: M16 X 1.5-6H INT	FS19624  DAVCO 382113 Filter used with FH23027, FH23028, FH23029, FH23031, FH23032, FH23038, FH23039, FH23040, FH23041, FH23042, FH23045, FH23049, FH23050, FH23054, FH23302, FH23303, FH23304 Uses service part: 3946951S Fuel Pro or Diesel Pro applied EleMax cartridge element with Stratapore media. 7 micron absolute rating, 98.7% efficient @ 100 gph (378 lph). Filter used with FH230 Fuel Pro & FH233 Diesel Pro Series Housings, Davco 382 & 233 Series Housings.
FS19596  CUMMINS 3954891 Upgrade of FS1003 Overall Height: 9.73 (247) Largest OD: 3.69 (94) Standpipe: YES Thread Size: 1-14 UNS-2B	FS19612  CATERPILLAR 1512409 Pre-Filter type - Reverse flow type Overall Height: 5.02 (128) End 1 OD: 3.27 (83) End 2 OD: 2.73 (69) End 1 ID: 0.85 (22)	Gasket: 3901455, 3901456 Overall Height: 7.04 (179) Overall OD: 3.82 (97) End 1 ID: 0.66 (17)
FS19597  CUMMINS 2830348 Without Central Gasket Agricultural Applications Overall Height: 7.17 (182) Largest OD: 3.03 (77) Thread Size: M16 X 1.5-6H INT	FS19614  NEW HOLLAND 87801285 Final filter type Overall Height: 7.43 (189) End 1 OD: 3.27 (83) End 2 OD: 2.73 (69) End 2 ID: 0.85 (22)	FS19624G  DAVCO 382113 Green GrometBio-Diesel Compatible Overall Height: 7.04 (179) Overall OD: 3.82 (97) End 1 ID: 0.66 (17)
FS19598  CUMMINS 3990130, CHRYSLER 4883963AC Uses service part: 3898280S, 3898281S, 3898282S, 3898285S Overall Height: 4.34 (110) End 1 OD: 4.23 (107) End 2 OD: 3.23 (82) End 1 ID: 0.75 (19) End 2 ID: 1.26 (32)	FS19615  LIEBHERR 7412710 Height: 1.21 (31) Length: 2.95 (75) Width: 2.95 (75)	FS19627  RACOR R12P Overall Height: 2.37 (60) Largest OD: 3.00 (76) Thread Size: 18 X 1.5 MM
FS19599  M.A.N. 51125030040 Stratapore version of FF5135 Overall Height: 6.14 (156) Largest OD: 3.03 (77) Thread Size: M16 X 1.5-6H INT	FS19616  CUMMINS 3991498 Uses service part: 3953517S Overall Height: 7.59 (193) Largest OD: 3.69 (94) Standpipe: YES Thread Size: M20 X 1.5-6H INT	FS19628  RACOR R12S Overall Height: 2.37 (60) Largest OD: 3.00 (76) Thread Size: 18 X 1.5 MM
FS19602  CUMMINS 3991179 Overall Height: 7.57 (192) Largest OD: 3.69 (94) Thread Size: 13/16-18 UNS-2B	FS19617  CUMMINS 3963837 Overall Height: 6.97 (177) Largest OD: 3.68 (93) Thread Size: 13/16-18 UNS-2B	FS19634  CUMMINS 4962810
FS19605  SEPAR 1030 Height: 2.50 (64) Length: 3.50 (89) Width: 3.47 (88)	FS19680  CUMMINS 2830997 Overall Height: 6.42 (163) Largest OD: 3.03 (77) Thread Size: M16 X 1.5-6H INT	

E. PRODUCT GUIDE

FS19683 Caterpillar Applications



Overall Height: 7.38 (187)
Largest OD: 3.69 (94)
Thread Size: 1-14 UNS-2B

FS19684E INTERNATIONAL TRUCKS 1842638C91 Product is not available in all regions of the world



Overall Height: 5.58 (142)
End 1 OD: 3.74 (95)
End 2 OD: 3.57 (91)
End 2 ID: 0.82 (21)

FS19684P International I-313 engine INTERNATIONAL TRUCKS 1841393C1

FS19687 NEW HOLLAND 87840136 Uses service part: 3948395S



Overall Height: 5.18 (132)
Largest OD: 4.35 (111)
Thread Size: 1-14 UNS-2B

FS19688 JOHN DEERE RE521818



Overall Height: 11.40 (290)
Largest OD: 4.25 (108)
Thread Size: 1-12 UNS-2B

FS19689 LEYLAND 1618993



Overall Height: 8.61 (219)
Largest OD: 3.68 (94)
Thread Size: M20 X 1.5-6H INT

FS19700 Similar to FS19688 except it has different slit width, no WIF sensor and 7/8-14 threads.



Overall Height: 6.73 (171)
Largest OD: 4.25 (108)
Thread Size: 7/8-14 UN-2B

FS19701 Similar to FS19688 except it has different media and 1-14 threads.



Overall Height: 11.40 (290)
Largest OD: 4.25 (108)
Thread Size: 1-14 UN-2B

FS19704 VOLVO 20386080



Overall Height: 5.66 (144)
Largest OD: 3.80 (97)
Thread Size: 1-14 UNS-2B

FS19709 TORO 638300 Replaces 85242A, 85470B, 85470N



Overall Height: 3.32 (84)
Largest OD: 3.07 (78)
Thread Size: M16 X 1.5-6H INT

FS19727 DAVCO 382122 Upgrade of FS1029W 10 Micron Stratapore, FH230 Series, FH233 Series, Davco 382, and Davco 233 Applications



Overall Height: 7.04 (179)
Overall OD: 3.82 (97)
End 1 ID: 0.66 (17)

FS19727G DAVCO 382122 Green Gromet Bio-Diesel Compatible

Overall Height: 7.04 (179)
Overall OD: 3.82 (97)
End 1 ID: 0.66 (17)

FS19728 DAVCO 382119 Filter used with FH23308 Davco Applications Fuel Pro FH230 series/Davco 382 series housings



Overall Height: 7.04 (179)
Overall OD: 3.82 (97)
End 1 ID: 0.66 (17)

FS19728G DAVCO 382119 Green Gromet Bio-Diesel Compatible

Overall Height: 7.04 (179)
Overall OD: 3.82 (97)
End 1 ID: 0.66 (17)

FS19729 DAVCO 382115 Fuel Pro or Diesel Pro applied EleMax cartridge element with cellulose media. 50 micron absolute rating, 98.7% efficient @ 150 gph (568 lph). Applications include Cummins ISX 2002+ EGR engines. Filter used with FH230 Fuel Pro & FH233 Diesel Pro Series Housings, Davco 382 & 233 Series Housings.



Gasket: 3901455, 3901456
Overall Height: 7.04 (179)
Overall OD: 3.82 (97)
End 1 ID: 0.66 (17)

FS19729G DAVCO 382115 Green Gromet Bio-Diesel Compatible

Overall Height: 7.04 (179)
Overall OD: 3.82 (97)
End 1 ID: 0.66 (17)

FS19730 DAVCO 232012, DAVCO 232014 Filter used with FH23200, FH23201, FH23202 Fuel Pro FH232 Series. Stratapore Media 7 micron, 98% efficient at Free Water per SAE J1839 and 98% efficient at Emulsified Water per SAE J1488.



Overall Height: 4.69 (119)
End 1 OD: 3.50 (89)
End 2 OD: 3.48 (88)
End 1 ID: 0.66 (17)

FS19730G DAVCO 232012 Green Gromet Bio-Diesel Compatible

Overall Height: 4.69 (119)
End 1 OD: 3.50 (89)
End 2 OD: 3.48 (88)
End 1 ID: 0.66 (17)

FS19730G DAVCO 232012 Green Gromet Bio-Diesel Compatible

Overall Height: 4.69 (119)
End 1 OD: 3.50 (89)
End 2 OD: 3.48 (88)
End 1 ID: 0.66 (17)

FS19731 DAVCO 232119 Filter used with FH23200, FH23201, FH23202 Fuel Pro FH232 Series. Stratapore Media 10 micron, 98% efficient at Free Water per SAE J1839 and 98% efficient at Emulsified Water per SAE J1488.



Overall Height: 4.69 (119)
End 1 OD: 3.50 (89)
End 2 OD: 3.48 (88)
End 1 ID: 0.66 (17)

FS19731G DAVCO 232119 Green Gromet Bio-Diesel Compatible

Overall Height: 4.69 (119)
End 1 OD: 3.50 (89)
End 2 OD: 3.48 (88)
End 1 ID: 0.66 (17)

FS19732 Filter used with 3944287S, 3975404 Cummins QSC, QSL Tier 3 2005



Overall Height: 7.58 (193)
Largest OD: 3.69 (94)
Thread Size: 1-14 UNS-2B

FS19733 SEPAR 530



Height: 0.95 (24)
Length: 2.95 (75)
Width: 2.95 (75)

FS19734 VOLVO 20381204 Uses service part: 3948395S



Overall Height: 3.45 (88)
Largest OD: 4.35 (111)
Thread Size: 1-14 UNS-2B

FS19735 VOLVO 20514654



Overall Height: 5.59 (142)
Largest OD: 3.80 (97)
Thread Size: 1-14UNS-2B INT

FS19736 VOLVO 11110189 Uses service part: 3948395S



Overall Height: 8.56 (218)
Largest OD: 4.35 (111)
Thread Size: 1-14 UNS-2B

FS19737 MERCEDES-BENZ A0004771302



Overall Height: 8.62 (219)
Largest OD: 4.35 (111)
Thread Size: 1-14 UNS-2B

FS19738 RACOR S3201T



Overall Height: 7.40 (188)
Overall OD: 3.62 (92)
End 1 ID: 0.99 (25)

E. PRODUCT GUIDE

FS19739 VETUS STM3690



Overall Height: 4.33 (110)
Largest OD: 3.03 (77)
Thread Size: M16 X 1.5-6H INT

FS19742 CIM-TEK 70060 Fuel Pump Applications



Overall Height: 5.36 (136)
Largest OD: 3.75 (95)
Thread Size: 1 1/2-16 UNF

FS19743 CIM-TEK 70064 Fuel Pump Applications



Overall Height: 5.36 (136)
Largest OD: 3.69 (94)
Thread Size: 1-12 UNF-2B

FS19744 CIM-TEK 70065 Fuel Pump Applications



Overall Height: 5.36 (136)
Largest OD: 3.75 (95)
Thread Size: 1 1/2-16 UNF

FS19746 CIM-TEK 70061 Fuel Pump Applications



Overall Height: 8.60 (218)
Largest OD: 3.65 (93)
Thread Size: 1 3/8-12 UNF

FS19748 CIM-TEK 70067, CIM-TEK CT70067 Fuel Pump Applications



Overall Height: 8.60 (218)
Largest OD: 3.69 (94)
Thread Size: NONE

FS19749 CIM-TEK 70066 Fuel Pump Applications



Overall Height: 8.60 (218)
Largest OD: 3.65 (93)
Thread Size: NONE

FS19752 SEPAR 1830



Height: 2.50 (64)
Length: 5.61 (143)
Width: 5.61 (143)

FS19753 VOLVO CONSTRUCTION EQUIPMENT 11110474 Uses service part: 3948395S



Overall Height: 8.56 (218)
Largest OD: 4.35 (111)
Thread Size: 1-14 UNS-2B

FS19754 RACOR R120P



Overall Height: 8.70 (221)
Largest OD: 4.35 (111)
Thread Size: 1-14 UNS-2B

FS19761 DAVCO 102529 FH230 Fuel Pro & FH233 Diesel Pro Series Housings, Davco 382 & 233 Series Housings



Overall Height: 7.04 (179)
Overall OD: 3.82 (97)
End 1 ID: 0.66 (17)

FS19761G DAVCO 102529 Green Gromet Bio-Diesel Compatible



Overall Height: 7.04 (179)
Overall OD: 3.82 (97)
End 1 ID: 0.66 (17)

FS19762 For Upgrade, use FS19557, FS19559



Overall Height: 6.47 (164)
Overall OD: 4.62 (117)
End 1 ID: 0.65 (17)

FS19763 DAVCO 102526, DAVCO 102011 Filter used with FH23466 Plus size version of FS19624 for Extended Service Intervals when used in FH230 Series Fuel Pro's or standard for FH234 Series Industrial Pro



Overall Height: 7.04 (179)
Overall OD: 4.21 (107)
End 1 ID: 0.66 (17)

FS19764 DAVCO 102527 Plus size version of FS19624 for Extended Service Intervals when used in FH230 Series Fuel Pro's or standard for FH234 Series Industrial Pro



Overall Height: 7.04 (179)
Overall OD: 4.21 (107)
End 1 ID: 0.66 (17)

FS19765 DAVCO 102528 Filter used with FH23435, FH23447, FH23448, FH23453 Plus size version of FS19624 for Extended Service Intervals when used in FH230 Series Fuel Pro's or standard for FH234 Series Industrial Pro



Overall Height: 7.04 (179)
Overall OD: 4.21 (107)
End 1 ID: 0.66 (17)

FS19766 DAVCO 102525 Plus size version of FS19624 for Extended Service Intervals when used in FH230 Series Fuel Pro's or standard for FH234 Series Industrial Pro



Overall Height: 7.04 (179)
Overall OD: 4.21 (107)
End 1 ID: 0.66 (17)

FS19768 FUEL PREPARATOR WS80



Overall Height: 5.58 (142)
Largest OD: 3.02 (77)
Thread Size: 3/4-16 UNF-2B

FS19769 DAF 1433649



Overall Height: 9.06 (230)
Largest OD: 4.35 (111)
Thread Size: 1-14UNS-1B INT

FS19772 CUMMINS 2830359



Overall Height: 6.84 (174)
Largest OD: 3.69 (94)
Thread Size: M16 X 1.5-6H INT

FS19773 CUMMINS 2830348 Includes Central Gasket



Overall Height: 6.94 (176)
Largest OD: 3.05 (77)
Thread Size: M16 X 1.5-6H INT

FS19774 CUMMINS 2830997



Overall Height: 6.25 (159)
Largest OD: 3.05 (77)
Thread Size: M16 X 1.5-6H INT

FS19775 RACOR R45P



Overall Height: 3.45 (88)
Largest OD: 4.35 (111)
Thread Size: 1-14 UNS-2B

FS19776 CATERPILLAR 1466695 Bowl not included



Overall Height: 7.92 (201)
Largest OD: 3.69 (94)
Thread Size: 1-14 UNS-2B

FS19778 RACOR R25T



Overall Height: 5.66 (144)
Largest OD: 3.80 (97)
Thread Size: 1-14 UNS-2B

FS19779 RACOR R25S



Overall Height: 5.66 (144)
Largest OD: 3.80 (97)
Thread Size: 1-14 UNS-2B

E. PRODUCT GUIDE

FS19781 IVECO 2992300



Overall Height: 7.30 (186)
Largest OD: 3.45 (88)
Standpipe: YES
Thread Size: M16 X 1.5-6H INT

FS19784 CUMMINS 4931955 Cummins QSC, QSL Tier 3 2005. Similar to FS19732 with the exception of metal valvescrew.



Overall Height: 7.89 (200)
Largest OD: 3.70 (94)
Standpipe: YES
Thread Size: 1-14 UNS-2B

FS19785 DAVCO 232115 Filter used with FH23200, FH23201, FH23202 Diesel Pro FH232 Series. Stratapore Media 25 micron, 98% efficient at Free Water per SAE J1839 and 98% efficient at Emulsified Water per SAE J1488.



Overall Height: 4.70 (119)
End 1 OD: 3.50 (89)
End 2 OD: 3.48 (88)
End 1 ID: 0.66 (17)

FS19785G DAVCO 232115 Green Gromet Bio-Diesel Compatible

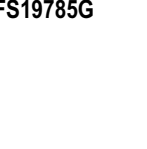

Overall Height: 4.70 (119)
End 1 OD: 3.50 (89)
End 2 OD: 3.48 (88)
End 1 ID: 0.66 (17)

FS19786 MASTER VOLT 50230092



Overall Height: 7.09 (180)
Largest OD: 3.03 (77)
Thread Size: M16 X 1.5-6H INT

FS19791 CUMMINS 4934158



Overall Height: 7.09 (180)
Largest OD: 3.03 (77)
Thread Size: M16 X 1.5-6H INT

FS19792 NEW HOLLAND 87801434



Overall Height: 4.27 (108)
End 1 OD: 3.27 (83)
End 2 OD: 2.73 (69)

FS19793 CATERPILLAR 1454501



Overall Height: 7.67 (195)
End 1 OD: 3.27 (83)
End 2 OD: 2.73 (69)

FS19794 JOHN DEERE RE508633



Overall Height: 7.67 (195)
End 1 OD: 3.27 (83)
End 2 OD: 2.73 (69)

FS19797 FORD 3C3Z9N184CA Kit contains two filters 2003 & 2004 Ford E Series 6.0L Engine Applications



Overall Height: 4.24 (108)
Overall OD: 3.34 (85)

FS19798 RACOR S3226T



Overall Height: 6.25 (159)
Largest OD: 4.38 (111)
Thread Size: 1-14 UNS-2B

FS19799 RACOR S3238P



Overall Height: 6.25 (159)
Largest OD: 4.38 (111)
Thread Size: 1-14 UNS-2B

FS19802 RACOR R12T



Overall Height: 2.37 (60)
Largest OD: 3.00 (76)

FS19803 SEPAR 4030



Height: 2.01 (51)
Length: 7.21 (183)
Width: 7.05 (179)

FS19804 Filter used with FH23411, FH23412, FH23413, FH23414, FH23417, FH23418, FH23446 Replacement element for Sea Pro 6 Series with 25 Micron Stratapore Media.



Overall Height: 12.32 (313)
Largest OD: 4.74 (120)
Standpipe: YES
Thread Size: 1 1/4-12 UNS-2B

FS19805 CUMMINS 4941237



Overall Height: 5.21 (132)
Largest OD: 3.70 (94)
Thread Size: M22 X 1.5-6H INT

FS19807 RACOR R50404



Overall Height: 6.15 (156)
Overall OD: 4.36 (111)
Thread Size: 1-14 UNS-2B

FS19810 RENAULT TRUCKS 5001846015



Overall Height: 6.58 (167)
End 1 OD: 3.31 (84)
End 2 OD: 3.11 (79)
End 1 ID: 0.67 (17)

FS19811 MASSEY-FERGUSON 3780299M1



Overall Height: 5.08 (129)
End 1 OD: 3.31 (84)
End 2 OD: 3.11 (79)
End 1 ID: 0.67 (17)

FS19812 STANADYNE 32243, STANADYNE 32311



Overall Height: 7.76 (197)
End 1 OD: 3.31 (84)
End 2 OD: 3.11 (79)
End 1 ID: 0.67 (17)

FS19813 CATERPILLAR 1512409



Overall Height: 5.08 (129)
End 1 OD: 3.31 (84)
End 2 OD: 3.11 (79)
End 1 ID: 0.51 (13)

FS19814 NEW HOLLAND 87840591



Overall Height: 5.81 (148)
End 1 OD: 3.31 (84)
End 2 OD: 3.11 (79)
End 1 ID: 0.67 (17)

FS19820 CATERPILLAR 1R0770



Overall Height: 10.08 (256)
Largest OD: 4.25 (108)
Thread Size: 1-14 UNS-2B

FS19821 IVECO 2992662



Overall Height: 7.72 (196)
Largest OD: 3.68 (94)
Thread Size: M16 X 1.5-6H INT

FS19823 CHRYSLER 68020642AA For use with B20 Biodiesel Fuel



Overall Height: 7.97 (202)
Largest OD: 3.69 (94)
Thread Size: 1-14 UNS-2B

FS19824 RACOR R15P



Overall Height: 3.33 (85)
Largest OD: 3.80 (97)
Thread Size: 1-14 UNS-2B

FS19826 SISU 836862600



Overall Height: 6.81 (173)
End 1 OD: 3.31 (84)
End 2 OD: 3.11 (79)
End 1 ID: 0.67 (17)

FS19827 RENAULT D.M.A. 6005028152











Overall Height: 7.76 (197)
End 1 OD: 3.31 (84)
End 2 OD: 3.11 (79)
End 1 ID: 0.67 (17)







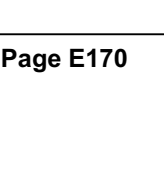

FS19829 RENAULT D.M.A. 6005028977, JOHN DEERE RE509031











Overall Height: 6.08 (155)
End 1 OD: 3.31 (84)
End 2 OD: 3.11 (79)
End 1 ID: 0.67 (17)







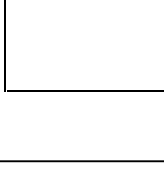











E. PRODUCT GUIDE

FS19830	RENAULT D.M.A. 6005028153	
	Overall Height: 6.08 (155) End 1 OD: 3.31 (84) End 2 OD: 3.11 (79) End 1 ID: 0.67 (17)	
FS19831	RENAULT AGRICULTURE 6005023306	
	Overall Height: 5.32 (135) End 1 OD: 3.31 (84) End 2 OD: 3.11 (79) End 1 ID: 0.67 (17)	
FS19832	PERKINS 26560143, CATERPILLAR 1596102, CATERPILLAR 1383098	
	Overall Height: 6.08 (155) End 1 OD: 3.31 (84) End 2 OD: 3.11 (79) End 1 ID: 0.67 (17)	
FS19833	JOHN DEERE RE509032	
	Overall Height: 7.76 (197) End 1 OD: 3.31 (84) End 2 OD: 3.11 (79) End 1 ID: 0.67 (17)	
FS19835	JOHN DEERE RE508633	
	Overall Height: 7.76 (197) End 1 OD: 3.31 (84) End 2 OD: 3.11 (79) End 1 ID: 0.67 (17)	
FS19836	MASSEY-FERGUSON 3780931M1	
	Overall Height: 5.32 (135) End 1 OD: 3.31 (84) End 2 OD: 3.11 (79) End 1 ID: 0.67 (17)	
FS19837	FORD 4032667	
	Overall Height: 7.76 (197) End 1 OD: 3.31 (84) End 2 OD: 3.11 (79) End 1 ID: 0.67 (17)	
FS19838	INGERSOLL-RAND 85400976, JOHN DEERE RE60021	
	Overall Height: 4.57 (116) End 1 OD: 3.31 (84) End 2 OD: 3.11 (79) End 1 ID: 0.67 (17)	
FS19839	CATERPILLAR 1311812	
	Overall Height: 6.06 (154) End 1 OD: 3.31 (84) End 2 OD: 3.11 (79) End 1 ID: 0.67 (17)	





















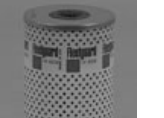

FS19840	STANADYNE 31616	
	Overall Height: 6.81 (173) End 1 OD: 3.31 (84) End 2 OD: 3.11 (79) End 1 ID: 0.67 (17)	
FS19841	Filter used with FH23460, FH23461, FH23462, FH23463, FH23464, FH23469, FH23470, FH23471, FH23472, FH23473	
	Overall Height: 12.32 (313) Largest OD: 4.74 (120) Standpipe: YES Thread Size: 1 1/4-12 UNS-2B	
FS19843	BALDWIN BF1351SP, CATERPILLAR 1R0769	
	Overall Height: 9.98 (254) Largest OD: 4.25 (108) Thread Size: 1-14 UNS-2B	
FS19844	FORD 4C2Z9N184BA Fuel Filter kit for 6.0 ITEC in Ford Econoline Vans	
	Overall Height: 3.11 (79) Overall OD: 3.75 (95)	
FS19845	BALDWIN BF1329	
	Overall Height: 8.23 (209) Largest OD: 4.28 (109) Thread Size: 1-14 UNS-2B	
FS19846	BALDWIN BF1348	
	Overall Height: 6.78 (172) Largest OD: 4.30 (109) Thread Size: 1-14 UNS-2B	
FS19847	BALDWIN BF1346	
	Overall Height: 6.30 (160) Largest OD: 4.25 (108) Thread Size: 1-14 UNS-2B	
FS19855	CHRYSLER 5015581AD Filter used with FS1269 ULSD compatible version of FS19579	
	Overall Height: 4.10 (104) End 1 OD: 3.41 (87) End 2 OD: 3.24 (82) End 2 ID: 0.82 (21)	
FS19856	CHRYSLER 68001914AB, CUMMINS 4935205 ULSD compatible version of FS19800	
	Overall Height: 4.10 (104) End 1 OD: 3.41 (87) End 2 OD: 3.24 (82) End 2 ID: 0.82 (21)	

FS19857	JOHN DEERE RE62424	
	Overall Height: 6.08 (155) End 1 OD: 3.31 (84) End 2 OD: 3.11 (79) End 1 ID: 0.67 (17)	
FS19858	CATERPILLAR 1174089	
	Overall Height: 6.08 (155) End 1 OD: 3.31 (84) End 2 OD: 3.11 (79) End 1 ID: 0.67 (17)	
FS19859	LIEBHERR 7381877	
	Overall Height: 6.08 (155) End 1 OD: 3.31 (84) End 2 OD: 3.11 (79) End 1 ID: 0.67 (17)	
FS19860	CATERPILLAR 1561200	
	Overall Height: 5.32 (135) End 1 OD: 3.31 (84) End 2 OD: 3.11 (79) End 1 ID: 0.67 (17)	
FS19861	JOHN DEERE RE62419	
	Overall Height: 6.08 (155) End 1 OD: 3.31 (84) End 2 OD: 3.11 (79) End 1 ID: 0.67 (17)	
FS19862	LIEBHERR 7381645	
	Overall Height: 6.08 (155) End 1 OD: 3.31 (84) End 2 OD: 3.11 (79) End 1 ID: 0.67 (17)	
FS19863	PERKINS 26560141	
	Overall Height: 7.76 (197) End 1 OD: 3.31 (84) End 2 OD: 3.11 (79) End 1 ID: 0.67 (17)	
FS19864	NEW HOLLAND 87801285, CASE 87802925	
	Overall Height: 7.76 (197) End 1 OD: 3.31 (84) End 2 OD: 3.11 (79) End 1 ID: 0.67 (17)	
FS19865	JOHN DEERE RE509032	
	Overall Height: 7.67 (195) End 1 OD: 3.27 (83) End 2 OD: 2.73 (69)	

E. PRODUCT GUIDE

<p>FS19867 Upgrade for FS19629</p> <p>Overall Height: 4.07 (103) End 1 OD: 3.41 (87) End 2 OD: 3.24 (82) End 2 ID: 0.82 (21)</p>	<p>FS20000 CUMMINS 3966406 Filter used with 3940777S, 3960461S Tier 2 QSB applications in light fuel Low lubricity fuel filter continuously releases a lubricity-enhancing agent</p>  <p>Overall Height: 9.81 (249) Largest OD: 3.68 (93) Thread Size: 1 1/8-16 UN-2B</p>	<p>FS20401 RACOR 2040SM</p>  <p>Overall Height: 4.63 (118) End 1 OD: 4.35 (111) End 2 OD: 5.04 (128) End 1 ID: 0.83 (21) End 2 ID: 0.65 (17)</p>
<p>FS19868 JOHN DEERE RE509031</p> <p>Overall Height: 6.00 (152) End 1 OD: 3.27 (83) End 2 OD: 2.73 (69)</p>	<p>FS20022 Filter used with 3944287S, 3975404 Slow release lubricity enhancing fuel filter</p>  <p>Overall Height: 9.79 (249) Largest OD: 3.69 (94) Thread Size: 1 1/8-16 UN-2B</p>	<p>FS20402 RACOR 2040TM</p>  <p>Overall Height: 4.63 (118) End 1 OD: 4.35 (111) End 2 OD: 5.04 (128) End 1 ID: 0.83 (21) End 2 ID: 0.65 (17)</p>
<p>FS19895 RENAULT V.I. 7420851191</p>  <p>Overall Height: 5.14 (131) Largest OD: 4.35 (111) Thread Size: 1-14 UNS-2B</p>	<p>FS20101 RACOR 2010SM</p>  <p>Overall Height: 2.87 (73) Overall OD: 3.05 (78) End 1 ID: 0.59 (15) End 2 ID: 0.65 (17)</p>	<p>FS20403 RACOR 2040PM</p>  <p>Overall Height: 4.63 (118) End 1 OD: 4.35 (111) End 2 OD: 5.04 (128) End 1 ID: 0.83 (21) End 2 ID: 0.65 (17)</p>
<p>FS19896 VOLVO 3817517</p> <p>Overall Height: 8.62 (219) Largest OD: 4.35 (111) Thread Size: 1-12 UNF-2B</p>	<p>FS20102 RACOR 2010TM</p>  <p>Overall Height: 2.78 (71) Overall OD: 3.08 (78) End 1 ID: 0.64 (16)</p>	<p>FS43252 CHRYSLER 5183410AA, MOPAR 4936025</p>  <p>Overall Height: 9.253 (235.03) End 1 OD: 4.469 (113.51) Thread Size: M105 X 4 Special Butt</p>
<p>FS19897 LIEBHERR 10044303</p>  <p>Overall Height: 5.87 (149) Largest OD: 4.37 (111) Thread Size: 1-14 UNS-2B</p>	<p>FS20103 RACOR 2010PM</p>  <p>Overall Height: 2.78 (71) Overall OD: 3.08 (78)</p>	<p>Hydraulic Filters</p>
<p>FS19902 CUMMINS 4992119 Pre-filter for QSB3.3</p>	<p>FS20201 RACOR 2020SM</p>  <p>Overall Height: 9.63 (245) End 1 OD: 4.35 (111) End 2 OD: 5.04 (128) End 1 ID: 0.83 (21) End 2 ID: 0.65 (17)</p>	<p>HF6000 CASE 401073R2, CASE 530144R92</p>  <p>Gasket: 328797, 328798, 3310302 Overall Height: 3.01 (76) Overall OD: 5.06 (129) End 1 ID: 2.93 (74)</p>
<p>FS19904 FORD YC359176AA, RACOR F5527</p> <p>Overall Height: 4.00 (102) Largest OD: 3.64 (92) Thread Size: 1-14 UNS-2B</p>	<p>FS20202 RACOR 2020TM Upgrade of FS20203</p>  <p>Overall Height: 9.63 (245) End 1 OD: 4.35 (111) End 2 OD: 5.04 (128) End 1 ID: 0.83 (21) End 2 ID: 0.65 (17)</p>	<p>HF6001 FIAT-ALLIS 70253952</p>  <p>Overall Height: 6.82 (173) Largest OD: 3.81 (97) ADBV: Yes Thread Size: 13/16-16 UNS-2B</p>
<p>FS19905G DAVCO 382134</p> <p>Overall Height: 7.04 (179) Overall OD: 4.21 (107) End 1 ID: 0.66 (17)</p>	<p>FS20203 RACOR 2020PM For Upgrade, use FS20202</p>  <p>Overall Height: 9.63 (245) End 1 OD: 4.35 (111) End 2 OD: 5.04 (128) End 1 ID: 0.83 (21) End 2 ID: 0.65 (17)</p>	<p>HF6002 CHAR-LYNN 5604</p>  <p>Overall Height: 5.79 (147) Largest OD: 3.73 (95) Thread Size: 1 1/4-12 UNF-2B</p>
<p>FS19906 JOHN DEERE RE509036</p> <p>Overall Height: 7.76 (197) End 1 OD: 3.31 (84) End 2 OD: 3.11 (79) End 1 ID: 0.67 (17)</p>	<p>FS19910 RACOR R52P</p> <p>Overall Height: 2.85 (73) Largest OD: 4.35 (111) Thread Size: 1-14 UNS-2B</p>	<p>HF6003 CHAR-LYNN 5610</p>  <p>Overall Height: 5.79 (147) Largest OD: 3.73 (95) Thread Size: 1 1/4-12 UNF-2B</p>
<p>FS19907 MANN & HUMMEL PL270X</p>  <p>Overall Height: 5.98 (152) Largest OD: 4.35 (111) Thread Size: 1-14 UNS-2B</p>	<p>FS19912 JOHN DEERE RE508202</p> <p>Overall Height: 6.00 (152) End 1 OD: 3.27 (83) End 2 OD: 2.73 (69) End 1 ID: 0.85 (22)</p>	
<p>FS19914 LIEBHERR 10101998</p> <p>Overall Height: 8.64 (220) Largest OD: 4.35 (111) Thread Size: 1-14 UNS-2B</p>		

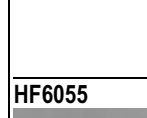
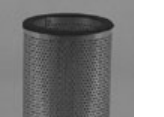













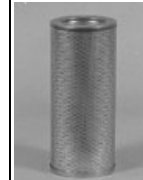





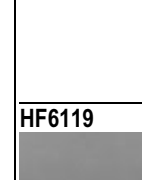

E. PRODUCT GUIDE

HF6004 CASE A44012  Gasket: 3836935 Overall Height: 7.06 (179) End 1 OD: 4.52 (115) End 2 OD: 4.51 (115) End 1 ID: 0.53 (13) End 2 ID: 2.25 (57)	HF6013 CASE A36524, CASE A51463  Overall Height: 6.01 (153) Overall OD: 2.33 (59) End 1 ID: 1.36 (35)	HF6023 JOHN DEERE AH76668  Overall Height: 8.00 (203) Overall OD: 3.38 (86) End 1 ID: 2.57 (65)
HF6005 VICKERS 350577, CESSNA 62200AF  Overall Height: 5.79 (147) Largest OD: 3.73 (95) Thread Size: 1 1/8-16 UN-2B	HF6014 FORD C7NNF882A, FORD C8NNE882B Ford C8NN-E882B  Overall Height: 6.00 (152) End 1 OD: 6.50 (165) End 2 OD: 6.00 (152) End 1 ID: 2.41 (61)	HF6024 CASE 113940C1  Overall Height: 8.93 (227) Overall OD: 4.87 (124) End 1 ID: 2.88 (73)
HF6006 REXNORD 493143  Overall Height: 5.06 (129) End 1 OD: 4.52 (115) End 2 OD: 4.51 (115) End 1 ID: 0.53 (13) End 2 ID: 2.25 (57)	HF6016 CASE 878015C3  Overall Height: 9.12 (232) Overall OD: 5.97 (152) End 1 ID: 2.62 (67)	HF6025 A M GENERAL 5997769  Overall Height: 4.19 (106) Overall OD: 3.53 (90) End 1 ID: 0.86 (22) End 2 ID: 1.37 (35)
HF6007 CASE 267841C91  Overall Height: 3.59 (91) Overall OD: 2.35 (60) End 1 ID: 1.08 (27)	HF6017 JOHN DEERE AT39266  Overall Height: 7.97 (202) Overall OD: 4.52 (115) End 1 ID: 2.27 (58)	HF6028 CASE A46403, CASE A147925  Overall Height: 7.09 (180) Overall OD: 4.52 (115) End 1 ID: 2.27 (58)
HF6008 CASE A60524, CASE A61234  Gasket: 328081, 328082 Overall Height: 6.05 (154) Overall OD: 3.82 (97) End 1 ID: 1.08 (27)	HF6018 FIAT-ALLIS 70267300  Overall Height: 6.13 (156) Overall OD: 5.06 (129) End 1 ID: 2.93 (74)	HF6029 CASE 69848C1, CASE 69878C91  Gasket: 327834 Overall Height: 5.51 (140) Overall OD: 2.90 (74) End 1 ID: 1.12 (28)
HF6009 CASE A65854, CASE G34278  Gasket: 328081, 328082 Overall Height: 6.05 (154) Overall OD: 3.82 (97) End 1 ID: 1.08 (27)	HF6020 CASE 388085R92  Gasket: 323330, 323331 Overall Height: 3.63 (92) Overall OD: 7.24 (184) End 1 ID: 1.45 (37) End 2 ID: 2.87 (73)	HF6054 CASE 528493R3 Uses service part: 323344S, 3305996S, 3305997S, 3306000S, 3306001S  Gasket: 323343 ¹² , 323344 ¹⁰ , 3305996 ¹⁰ , 3305997 ¹⁰ , 3306000 ¹⁰ , 3306001 ¹⁰ Overall Height: 6.11 (155) Overall OD: 5.06 (129) End 1 ID: 2.93 (74)
HF6011 CASE D43800, CASE D43801  Gasket: 332288 Overall Height: 7.21 (183) Overall OD: 2.61 (66) End 1 ID: 1.22 (31)	HF6021 FIAT-ALLIS 70098441  Gasket: 314204 Overall Height: 7.00 (178) Overall OD: 4.52 (115) End 1 ID: 0.75 (19)	HF6055 FORD D1NNF933A  Overall Height: 6.92 (176) Largest OD: 3.73 (95) Thread Size: 1-12 UNF-2B
HF6012 JOHN DEERE AT24274  Overall Height: 7.19 (183) Overall OD: 4.39 (112) End 1 ID: 3.42 (87)	HF6022 WHITE 165442A  Gasket: 252556 Overall Height: 5.56 (141) Overall OD: 2.06 (52) End 1 ID: 0.91 (23)	HF6056 For Upgrade, use HF7608  Overall Height: 5.84 (148) Largest OD: 3.69 (94) Thread Size: 1-12 UNF-2B























E. PRODUCT GUIDE

HF6057  JOHN DEERE AT38431, VOLVO 100462, BUHLER 2854, GRESEN 8057000, CROSS 1A9023 Overall Height: 5.84 (148) Largest OD: 3.69 (94) Thread Size: 1-12 UNF-2B	HF6066  CASE 388080R93 Gasket: 323330, 323331 Overall Height: 2.50 (64) Overall OD: 7.24 (184) End 1 ID: 1.45 (37) End 2 ID: 2.87 (73)	HF6083  CATERPILLAR 7J0670 Uses service part: 3308694S For Upgrade, use HF6339 Gasket: 3308694 ¹⁰ Overall Height: 9.00 (229) Overall OD: 6.83 (173) End 1 ID: 3.94 (100)
HF6058  REXNORD 493309 Overall Height: 5.79 (147) Largest OD: 3.73 (95) Thread Size: 1-12 UNF-2B	HF6068  REXNORD 493218, DAVIS H311654 Overall Height: 5.79 (147) Largest OD: 3.73 (95) Thread Size: 1 1/8-16 UN-2B	HF6084  KOMATSU 2811611290 Gasket: 3303726 Overall Height: 9.12 (232) Overall OD: 4.00 (102) End 1 ID: 1.64 (42)
HF6059  GRESEN 3293 Uses service part: 3314250S, 3320571S Gasket: 333208 (2), 334021 Overall Height: 7.00 (178) Overall OD: 4.52 (115) End 1 ID: 1.80 (46)	HF6071  FIAT-ALLIS 70269310 Overall Height: 8.97 (228) Overall OD: 5.06 (129) End 1 ID: 2.93 (74)	HF6085  CASE 930654C1 Overall Height: 9.10 (231) Overall OD: 4.52 (115) End 1 ID: 1.75 (44)
HF6060  GRESEN 3294 Uses service part: 3314250S, 3320571S Gasket: 333208 (2) Overall Height: 7.00 (178) Overall OD: 4.52 (115) End 1 ID: 1.80 (46)	HF6072  KOMATSU 1754911580 Overall Height: 9.12 (232) End 1 OD: 4.00 (102) End 2 OD: 3.99 (101) End 1 ID: 1.64 (42) End 2 ID: 1.42 (36)	HF6086  ORENSTEIN & KOPPEL 124926 Overall Height: 6.35 (161) Overall OD: 5.17 (131) End 1 ID: 3.75 (95)
HF6061  CASE 631144C2 Gasket: 251139 (1) ¹⁰ Overall Height: 9.06 (230) End 1 OD: 4.51 (115) End 2 OD: 4.52 (115) End 1 ID: 2.25 (57) End 2 ID: 0.53 (13)	HF6079  JOHN DEERE AR75601, JOHN DEERE AR1400R, JOHN DEERE AR28271R Uses service part: 333763S Gasket: 333763 Overall Height: 5.47 (139) Overall OD: 4.62 (117) End 1 ID: 2.20 (56)	HF6087  KOMATSU 1754314130 Overall Height: 18.21 (463) Overall OD: 4.00 (102) End 1 ID: 1.64 (42) End 2 ID: 1.42 (36)
HF6062  TWIN DISC M2725A, REXNORD 493144 Gasket: 251139 ¹⁰ Overall Height: 9.06 (230) End 1 OD: 4.52 (115) End 2 OD: 4.51 (115) End 1 ID: 0.53 (13) End 2 ID: 2.25 (57)	HF6080  CASE A32297 Overall Height: 5.79 (147) Largest OD: 3.73 (95) Thread Size: 1-12 UNF-2B	HF6089  CLARK 2515079 Not to be used with flame retardant fluid Overall Height: 18.06 (459) Overall OD: 6.02 (153) End 1 ID: 0.66 (17)
HF6063  BRIGGS & STRATTON BP7181 Overall Height: 17.88 (454) Overall OD: 6.19 (157) End 1 ID: 2.56 (65)	HF6081  CASE 623017C1 Gasket: 328199 Overall Height: 9.00 (229) Overall OD: 5.06 (129) End 1 ID: 2.93 (74)	HF6090  KOMATSU 1016015171 Overall Height: 5.65 (144) Overall OD: 2.52 (64) End 1 ID: 1.00 (25)
HF6064  REXNORD 493136 Overall Height: 5.06 (129) End 1 OD: 4.52 (115) End 2 OD: 4.51 (115) End 1 ID: 0.53 (13) End 2 ID: 2.25 (57)	HF6082  CASE 666219C1 Overall Height: 12.12 (308) Overall OD: 6.49 (165) End 1 ID: 5.50 (140)	HF6091  HOUGH 185531H1 Overall Height: 4.81 (122) Overall OD: 2.63 (67) End 1 ID: 1.25 (32)



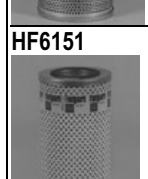





















E. PRODUCT GUIDE

HF6092  GMC 7194968 Overall Height: 3.36 (85) Overall OD: 2.75 (70) End 1 ID: 0.78 (20) End 2 ID: 0.31 (8)	HF6100  TWIN DISC M2725A, WABCO VK1626 Overall Height: 9.06 (230) End 1 OD: 4.52 (115) End 2 OD: 4.51 (115) End 1 ID: 0.53 (13) End 2 ID: 2.25 (57)	HF6115  NEW HOLLAND D8NNB486CAFORD D8NNB486CA Overall Height: 6.86 (174) Largest OD: 3.72 (94) BPV Setting: 7.98 (55) Thread Size: 1 1/8-16 UN-2B
HF6093  WABCO WA9652 Overall Height: 9.26 (235) Overall OD: 5.10 (130) End 1 ID: 3.35 (85)	HF6101  KOMATSU 1756027380 For Upgrade, use HF28977 Overall Height: 11.50 (292) Overall OD: 5.10 (130) End 1 ID: 3.35 (85)	HF6116  TENNANT 677182, PALL HC9540SUJ4H, CASE H335620, JOHN DEERE AE37594 Overall Height: 5.81 (148) Largest OD: 3.72 (94) Thread Size: 1 1/2-16 UN-2B
HF6094  VICKERS 228468, INGERSOLL-RAND 59681635, KOMATSU 381256R92 Gasket: 317506 Overall Height: 7.06 (179) End 1 OD: 4.52 (115) End 2 OD: 4.51 (115) End 1 ID: 2.25 (57)	HF6102  KOMATSU 1416018270 Overall Height: 11.50 (292) Overall OD: 5.12 (130) End 1 ID: 3.37 (86)	HF6117  CASE 113465C1 Gasket: 333269 Overall Height: 5.83 (148) Largest OD: 3.74 (95) Thread Size: 1 1/2-16 UN-2B
HF6095  FIAT-ALLIS 70640780 Overall Height: 9.05 (230) Overall OD: 4.51 (115) End 1 ID: 1.78 (45)	HF6103  JOHN DEERE AT69852 Overall Height: 8.05 (204) Largest OD: 3.74 (95) Thread Size: 1 1/2-16 UN-2B	HF6118  AC PF951, VOLVO 15052 Uses service part: 317237S, 3832879S For Upgrade, use HF6271 Hydraulic and Transmission applications for lube applications use LF509N Gasket: 173368 ¹⁰ , 317237 ¹⁰ , 322951, 333639, 3832879 ¹⁰ , 3841722 Overall Height: 8.91 (226) Overall OD: 4.51 (115) End 1 ID: 1.44 (37)
HF6096  CASE 395789R2 Overall Height: 3.85 (98) Largest OD: 3.70 (94) Thread Size: 3/4-16 UNF-2B	HF6107  GMC 25010543 GMC 6903488 Gasket: 3837033 Overall Height: 5.98 (152) Largest OD: 3.68 (93) Thread Size: 3/4-16 UNF-2B	HF6119  CASE 404886R1 Overall Height: 3.84 (98) Largest OD: 3.73 (95) Thread Size: 1-12 UNF-2B
HF6097  CATERPILLAR 9M9740 Uses service part: 3308690S, 3838223S, 3838229S For Upgrade, use HF6341 Gasket: 3308690 ¹⁰ , 3838223 ¹⁰ , 3838226 ¹⁰ , 3838229 ¹⁰ Overall Height: 9.25 (235) Overall OD: 3.99 (101) End 1 ID: 2.30 (58)	HF6109  SCHROEDER K3 For Upgrade, use HF7332 Overall Height: 9.23 (234) Overall OD: 3.93 (100) End 1 ID: 1.61 (41)	HF6120  REXNORD 493308 Overall Height: 3.85 (98) Largest OD: 3.71 (94) Thread Size: 1-12 UNF-2B
HF6098  CATERPILLAR 4J6064 Uses service part: 3308691S, 3308692S, 3308695S, 3838221S, 3838222S For Upgrade, use HF6342 Gasket: 3308691 ¹⁰ , 3308692 ¹⁰ , 3308693 ¹⁰ , 3308695 ¹⁰ , 3838221 ¹⁰ , 3838222 ¹⁰ , 3838225 ¹⁰ , 3838227 ¹⁰ Overall Height: 9.00 (229) Overall OD: 5.10 (130) End 1 ID: 3.35 (85)	HF6110  SCHROEDER K10 For Upgrade, use HF6343 Overall Height: 9.23 (234) Overall OD: 3.93 (100) End 1 ID: 1.61 (41)	HF6121  CASE H311647, FORD 30891689 Overall Height: 5.84 (148) Largest OD: 3.69 (94) Thread Size: 1-12 UNF-2B
HF6098  CATERPILLAR 4J6064 Uses service part: 3308691S, 3308692S, 3308695S, 3838221S, 3838222S For Upgrade, use HF6342 Gasket: 3308691 ¹⁰ , 3308692 ¹⁰ , 3308693 ¹⁰ , 3308695 ¹⁰ , 3838221 ¹⁰ , 3838222 ¹⁰ , 3838225 ¹⁰ , 3838227 ¹⁰ Overall Height: 9.00 (229) Overall OD: 5.10 (130) End 1 ID: 3.35 (85)	HF6111  SCHROEDER K25 Overall Height: 9.23 (234) Overall OD: 3.93 (100) End 1 ID: 1.61 (41)	











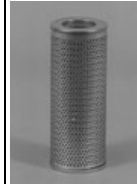





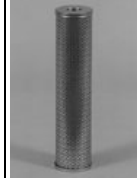

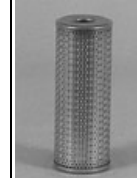

E. PRODUCT GUIDE

<p>HF6122 CLARK 6559458</p>  <p>Overall Height: 8.11 (206) Largest OD: 3.73 (95) Thread Size: 1-12 UNF-2B</p>	<p>HF6133 VICKERS 575942, VICKERS 736578</p>  <p>Gasket: 3312097¹⁰, 332418 Overall Height: 6.71 (170) Largest OD: 5.08 (129) Thread Size: 1 1/2-16 UN-2B</p>	<p>HF6144 VICKERS 426530</p>  <p>Overall Height: 8.96 (228) Overall OD: 4.00 (102) End 1 ID: 2.22 (56)</p>
<p>HF6123 FORD D8NNB486EA</p>  <p>Overall Height: 5.36 (136) Largest OD: 3.72 (94) BPV Setting: 7.98 (55) Thread Size: 1 1/8-16 UN-2B</p>	<p>HF6135 CROSS 1A9251</p>  <p>Gasket: 3312097¹⁰, 3316527 Overall Height: 8.96 (228) Largest OD: 5.08 (129) Thread Size: 1 1/2-16 UN-2B</p>	<p>HF6146 GRESEN 8074001</p>  <p>Overall Height: 7.00 (178) Overall OD: 4.52 (115) End 1 ID: 1.80 (46)</p>
<p>HF6125 CLARK 6552507</p>  <p>Gasket: 329753, 3312097¹⁰ Overall Height: 7.07 (180) Largest OD: 5.08 (129) Thread Size: 1 1/2-16 UN-2B</p>	<p>HF6136 CROSS 1A9253</p>  <p>Gasket: 3312097¹⁰, 3316527, 332418 Overall Height: 8.96 (228) Largest OD: 5.08 (129) Thread Size: 1 1/2-16 UN-2B</p>	<p>HF6147 JOHN DEERE AT62042</p>  <p>Overall Height: 7.18 (182) Overall OD: 4.52 (115) End 1 ID: 1.75 (44)</p>
<p>HF6128 JOHN DEERE AT73307</p>  <p>Gasket: 333269 Overall Height: 9.35 (237) Overall OD: 3.72 (94) Thread Size: 1 1/2-16 UN-2B</p>	<p>HF6137 SUNDSTRAND 9700653</p>  <p>Gasket: 3312097¹⁰, 332418 Overall Height: 8.96 (228) Largest OD: 5.08 (129) Thread Size: 1 1/2-16 UN-2B</p>	<p>HF6148 JOHN DEERE AT63548</p>  <p>Overall Height: 8.08 (205) Overall OD: 4.52 (115) End 1 ID: 2.27 (58)</p>
<p>HF6129 STEIGER 502689T91</p>  <p>Gasket: 333208, 3837027, 3837028 Overall Height: 7.00 (178) Overall OD: 4.52 (115) End 1 ID: 1.80 (46)</p>	<p>HF6138 CIM-TEK 70020</p>  <p>Gasket: 3312097¹⁰, 332418 Overall Height: 10.71 (272) Largest OD: 5.08 (129) Thread Size: 1 1/2-16 UN-2B</p>	<p>HF6149 TOWMOTOR 349804</p>  <p>Overall Height: 9.00 (229) Overall OD: 4.52 (115) End 1 ID: 2.27 (58)</p>
<p>HF6130 CASE H341974</p>  <p>Gasket: 329753, 3312097¹⁰ Overall Height: 6.71 (170) Largest OD: 5.08 (129) Thread Size: 1 1/2-16 UN-2B</p>	<p>HF6140 CASE A161845 For Upgrade, use HF6348</p>  <p>Gasket: 3312097¹⁰, 3826177 Overall Height: 10.71 (272) Largest OD: 5.08 (129) Thread Size: 1 1/2-16 UN-2B</p>	<p>HF6150 CASE L52029P</p>  <p>Overall Height: 9.00 (229) Overall OD: 4.52 (115) End 1 ID: 0.53 (13) End 2 ID: 2.25 (57)</p>
<p>HF6131 NEW HOLLAND D8NNB486EAFORD D8NNM903AA, BEHRINGER FLUID SYSTEMS, INC BSO128S10N383</p>  <p>Gasket: 329753, 3312097¹⁰ Overall Height: 6.71 (170) Largest OD: 5.08 (129) Thread Size: 1 1/2-16 UN-2B</p>	<p>HF6141 MANN & HUMMEL WD962, VOLVO 4787923 For ZF transmissions only</p>  <p>Overall Height: 8.29 (211) Largest OD: 3.68 (94) BPV Setting: 36.26 (250) Thread Size: 1-12 UNF-2B</p>	<p>HF6151 CASE 1140079C1</p>  <p>Overall Height: 9.12 (232) Overall OD: 4.52 (115) End 1 ID: 2.26 (57)</p>
<p>HF6132 Ford D8NN-M903-CA</p>  <p>Gasket: 329753, 3312097¹⁰ Overall Height: 6.71 (170) Largest OD: 5.08 (129) Thread Size: 1 1/2-16 UN-2B</p>	<p>HF6142 CASE G35446</p>  <p>Gasket: 326434, 328081, 328082, 335094 Overall Height: 6.05 (154) Overall OD: 3.82 (97) End 1 ID: 1.08 (27)</p>	<p>HF6152 CASE 113618C1, CASE 113618C1P, CASE 1240689C91</p>  <p>Gasket: 328797, 331032 Overall Height: 2.50 (64) Overall OD: 5.06 (129) End 1 ID: 2.93 (74)</p>

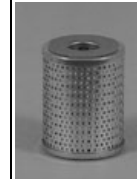









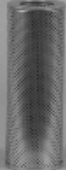
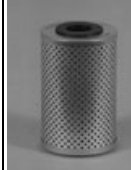

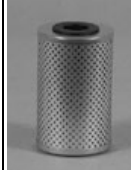

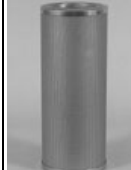

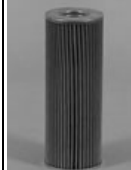

E. PRODUCT GUIDE

HF6153  JOHN DEERE AH91274, ROTH TANK COMPANY 156112 Overall Height: 6.20 (157) Overall OD: 5.06 (129) End 1 ID: 2.88 (73)	HF6164  JOHN DEERE AM39653 For Upgrade, use HF6446 Gasket: 331279 Overall Height: 3.85 (98) Largest OD: 3.72 (94) Thread Size: 3/4-16 UNF-2B	HF6173  J.C.B. 32902301 For Upgrade, use HF7983 Overall Height: 5.59 (142) Largest OD: 3.68 (94) Thread Size: 3/4-14 BSP
HF6156  CASE 475606C2 Gasket: 334823, 334824 Overall Height: 4.82 (122) End 1 OD: 3.48 (88) End 2 OD: 3.47 (88) End 2 ID: 1.36 (35)	HF6165  FIAT-ALLIS 706795132 Uses service part: 333763S Gasket: 333763 (1) ¹⁰ Overall Height: 7.23 (184) End 1 OD: 4.50 (114) End 2 OD: 4.46 (113) End 1 ID: 2.88 (73) End 2 ID: 2.22 (56)	HF6175  CROSLAND 518 Overall Height: 1.44 (37) Overall OD: 3.43 (87) End 1 ID: 1.10 (28)
HF6158  NISSAN 31725L1000 Overall Height: 3.45 (88) Largest OD: 3.04 (77) ADBV: Yes Thread Size: 3/4-16 UNS-2B	HF6166  MARVEL 54500, MARVEL 5763665125, MARVEL 5763665140 Overall Height: 7.25 (184) Overall OD: 4.50 (114) End 1 ID: 2.22 (56)	HF6176  FULLER A1781, PUROLATOR PF200L Gasket: 3843018 Overall Height: 2.91 (74) Overall OD: 3.01 (76) End 1 ID: 1.04 (26)
HF6159  NISSAN 5839647601 Overall Height: 5.59 (142) Largest OD: 3.68 (94) ADBV: Yes BPV Setting: 36.26 (250) Thread Size: 1-12 UNF-2B	HF6167  TORO 445340, CASE 69149C1, VOLVO 12754598 Gasket: 3312097 ¹⁰ , 3316527, 332418 Overall Height: 6.71 (170) Largest OD: 5.08 (129) Thread Size: 1 1/2-16 UN-2B	HF6177  UCC HYDRAULICS UCMX1591410 Filter used with 3904380 For Upgrade, use HF7980 Overall Height: 7.09 (180) Largest OD: 5.04 (128) Thread Size: 1 1/4 BSP
HF6160  CASE D59062 Overall Height: 5.13 (130) Largest OD: 3.80 (96) Thread Size: 1 5/16-12 UNS 2B	HF6168  HOUGH 877826C4 Overall Height: 18.12 (460) Overall OD: 5.97 (152) End 1 ID: 2.63 (67)	HF6178  AKERMAN 12919, VOLVO 4786819 Overall Height: 10.04 (255) Overall OD: 3.60 (92) End 1 ID: 1.97 (50)
HF6161  ZF 7633141101 Overall Height: 4.57 (116) Overall OD: 3.19 (81) End 1 ID: 0.51 (13)	HF6170  JOHN DEERE AT45422 Overall Height: 9.53 (242) Overall OD: 4.38 (111) End 1 ID: 0.69 (17)	HF6179  JOHN DEERE AE43494 Overall Height: 9.00 (229) Overall OD: 5.10 (130) End 1 ID: 2.82 (72)
HF6162  MERCEDES-BENZ 4660604 Overall Height: 3.96 (101) Overall OD: 2.32 (59) End 1 ID: 0.71 (18)	HF6171  FIAT-ALLIS 70669434 Gasket: 3309945, 3309947, 3310209 Overall Height: 12.75 (324) Overall OD: 4.51 (115) End 1 ID: 1.75 (44)	HF6180  RICHIER 568006001, POCLAIN N0250574, VOLVO 6638403, FAUN-FRISCH 4134431 Atlas 331055, 359455 Overall Height: 10.24 (260) Overall OD: 4.17 (106) End 1 ID: 0.35 (9) End 2 ID: 2.84 (72)
HF6163  CLARK 6591038 Gasket: 3312097 ¹⁰ , 3316527, 332418 Overall Height: 6.71 (170) Largest OD: 5.08 (129) Thread Size: 1 1/2-16 UN-2B	HF6172  MARVEL 6763665110 Overall Height: 7.44 (189) Overall OD: 4.50 (114) End 1 ID: 2.22 (56)	HF6181  POCLAIN J0150566, HYMAC 2700210 For Synthetic Version use HF7962 Overall Height: 8.27 (210) Overall OD: 4.96 (126) End 1 ID: 0.35 (9) End 2 ID: 3.62 (92)







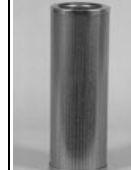



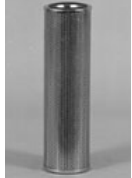

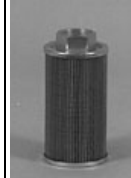

E. PRODUCT GUIDE

HF6182  ORENSTEIN & KOPPEL 511615, VOLVO 6210359, VOLVO 6635975 For Synthetic Media Version use HF28803 Overall Height: 11.42 (290) Overall OD: 4.96 (126) End 1 ID: 0.35 (9) End 2 ID: 3.62 (92)	HF6194  VICKERS 398856 Overall Height: 8.00 (203) Overall OD: 3.11 (79) End 1 ID: 1.86 (47)	HF6203  VICKERS 573082 Gasket: 333404 Overall Height: 5.69 (145) Largest OD: 3.72 (94) Thread Size: 1 1/8-16 UN-2B
HF6184  JOHN DEERE AR94510 Uses service part: 333763S Gasket: 333763 ¹⁰ Overall Height: 7.97 (202) Overall OD: 4.62 (117) End 1 ID: 2.20 (56)	HF6195  FIAT-ALLIS 70079170 GMC 2381012, IHC 169743-R91 Overall Height: 2.49 (63) Overall OD: 3.50 (89) End 1 ID: 1.06 (27)	HF6204  VICKERS 573083 Gasket: 333404 Overall Height: 5.69 (145) Largest OD: 3.72 (94) Thread Size: 1 1/8-16 UN-2B
HF6185  VICKERS 228467, INGERSOLL-RAND 51057255 Gasket: 318037 Overall Height: 4.47 (114) Overall OD: 2.90 (74) End 1 ID: 1.12 (28) End 2 ID: 0.49 (12)	HF6196  KOMATSU 1306048210 Overall Height: 10.94 (278) Overall OD: 2.52 (64) End 1 ID: 1.00 (25)	HF6205  ATLAS COPCO 16193771 Overall Height: 8.29 (211) Largest OD: 3.68 (94) BPV Setting: 36.26 (250) Thread Size: 1-12 UNF-2B
HF6186  RENAULT V.I. 7701015558 Overall Height: 5.91 (150) Overall OD: 2.68 (68) End 1 ID: 1.02 (26)	HF6197  KOMATSU 1454932430 Overall Height: 9.12 (232) Overall OD: 4.00 (102) End 1 ID: 1.64 (42)	HF6206  PETERBILT 10960 Overall Height: 6.91 (176) Largest OD: 3.73 (95) Thread Size: 1-12 UNF-2B
HF6187  CLARK 1530600 Not to be used with flame retardant fluid Gasket: 3310176, 3310177 Overall Height: 18.00 (457) Overall OD: 6.01 (153) End 1 ID: 2.73 (69)	HF6198  MICHIGAN 230962 Gasket: 3842592 Overall Height: 5.61 (142) Overall OD: 3.48 (88) End 1 ID: 1.14 (29)	HF6208  JOHN DEERE AT67960 Overall Height: 7.51 (191) Overall OD: 2.90 (74) End 1 ID: 1.12 (28)
HF6188  FORD D6NNB486A Overall Height: 6.61 (168) Largest OD: 3.98 (101) BPV Setting: 14.50 (100) Thread Size: 1 1/8-16 UN-2B	HF6200  CASE 666220C1 Overall Height: 15.03 (382) Overall OD: 6.50 (165) End 1 ID: 5.50 (140)	HF6209  JOHN DEERE AT67957 Overall Height: 3.74 (95) Overall OD: 2.90 (74) End 1 ID: 1.12 (28)
HF6190  PUROLATOR EP114 Uses service part: 3311273S Gasket: 251390 ¹⁰ , 3311273 ¹⁰ , 3842585 (2) Overall Height: 8.53 (217) Overall OD: 6.00 (152) End 1 ID: 3.44 (87)	HF6201  CATERPILLAR 4J816, CATERPILLAR 1R0728 Uses service part: 3838224S Gasket: 3838224 ¹⁰ Overall Height: 9.00 (229) Overall OD: 3.12 (79) End 1 ID: 1.86 (47)	HF6210  JOHN DEERE AT78414 Overall Height: 8.08 (205) Overall OD: 4.52 (115) End 1 ID: 2.27 (58)
HF6193  VICKERS 398854 Overall Height: 8.00 (203) Overall OD: 3.12 (79) End 1 ID: 1.86 (47)	HF6202  CATERPILLAR 9J0750, CATERPILLAR 9J5461 Uses service part: 3838228S For Upgrade, use HF6344 Gasket: 3838228 ¹⁰ Overall Height: 11.13 (283) Overall OD: 5.10 (130) End 1 ID: 3.35 (85)	HF6212  SCHROEDER A25 Overall Height: 4.86 (123) Overall OD: 3.00 (76) End 1 ID: 1.30 (33)





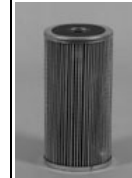





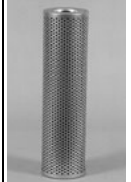
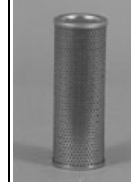
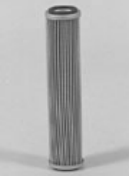
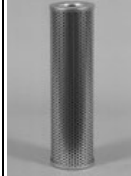
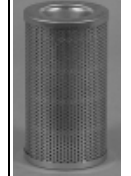

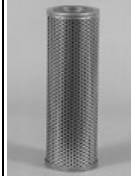
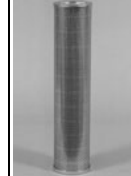

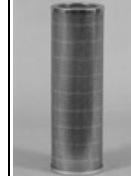
E. PRODUCT GUIDE

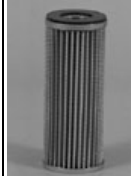
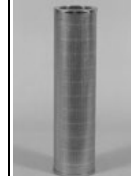
HF6213  KOMATSU 1446011160 Overall Height: 11.06 (281) Overall OD: 3.94 (100) End 1 ID: 2.34 (59)	HF6221  SCHROEDER A3 Overall Height: 4.88 (124) Overall OD: 3.00 (76) End 1 ID: 1.06 (27)	HF6239  RIPLEY 4P03 Gasket: 3826062 Overall Height: 4.31 (109) Overall OD: 2.81 (71) End 1 ID: 1.31 (33)
HF6214  CASE D35995 Overall Height: 7.44 (189) Overall OD: 4.50 (114) End 1 ID: 2.22 (56)	HF6222  SCHROEDER A10 Overall Height: 5.00 (127) Overall OD: 3.00 (76) End 1 ID: 1.06 (27)	HF6240  RIPLEY 8P03 Gasket: 3826062 Overall Height: 4.31 (109) Overall OD: 2.81 (71) End 1 ID: 1.31 (33)
HF6215  SCHROEDER KK3 Overall Height: 18.20 (462) Overall OD: 3.90 (99) End 1 ID: 1.81 (46)	HF6223  CASE 940241C2 Overall Height: 18.15 (461) Overall OD: 7.44 (189) End 1 ID: 4.85 (123)	HF6241  RIPLEY 4P13 Gasket: 3826061 Overall Height: 7.72 (196) Overall OD: 3.72 (94) End 1 ID: 1.98 (50)
HF6216  VICKERS 404208 Overall Height: 8.98 (228) Overall OD: 4.00 (102) End 1 ID: 2.23 (57)	HF6224  VERSATILE 36169 Gasket: 334823, 334824 Overall Height: 9.27 (235) BPV Setting: 17.50 (121) End 1 OD: 3.49 (89) End 2 OD: 3.47 (88) End 2 ID: 1.36 (35)	HF6242  RIPLEY 8P13 Gasket: 3826061 Overall Height: 7.72 (196) Overall OD: 3.72 (94) End 1 ID: 1.98 (50)
HF6217  VICKERS 404209 Overall Height: 17.96 (456) End 1 OD: 4.00 (102) End 2 OD: 3.99 (101) End 1 ID: 2.23 (57)	HF6225  AC PF889 Gasket: 3316886, 3316887, 333639 Overall Height: 8.91 (226) Overall OD: 4.51 (115) End 1 ID: 1.44 (37)	HF6243  NEW HOLLAND 73142551 Filter used with 3314849S For Upgrade, use HF6318 Gasket: 3826108 Overall Height: 10.30 (261) Largest OD: 4.67 (119) Thread Size: 1 5/16-12 UNS-2B
HF6218  VICKERS 404210 Overall Height: 8.98 (228) End 1 OD: 4.00 (102) End 2 OD: 3.99 (101) End 1 ID: 2.23 (57)	HF6226  FORD D8NNM903EA, FORD D8NNF914AA Gasket: 329753 Overall Height: 8.96 (228) Largest OD: 5.08 (129) Thread Size: 1 1/2-16 UN-2B	HF6244  WABCO PB4545 Uses service part: 3318304S Gasket: 3318304 ¹⁰ Overall Height: 18.73 (476) Overall OD: 5.10 (130) End 1 ID: 3.35 (85)
HF6219  VICKERS 404211 Overall Height: 17.96 (456) End 1 OD: 4.00 (102) End 2 OD: 3.99 (101) End 1 ID: 2.23 (57)	HF6237  CLARK 888331 Overall Height: 8.00 (203) Overall OD: 6.01 (153) End 1 ID: 3.53 (90)	HF6245  POCLAIN R1050586 Overall Height: 6.75 (172) Overall OD: 3.78 (96) End 1 ID: 2.68 (68) End 2 ID: 0.39 (10)
HF6220  MARVEL 6292065110 Overall Height: 4.87 (124) Overall OD: 2.61 (66) End 1 ID: 1.24 (32)	HF6238  GMC 15513845 Overall Height: 5.07 (129) Overall OD: 3.99 (101) End 1 ID: 1.31 (33) End 2 ID: 1.10 (28)	HF6246  LIEBHERR 7211198 Overall Height: 16.54 (420) Overall OD: 5.98 (152) End 1 ID: 3.47 (88) End 2 ID: 1.87 (48)

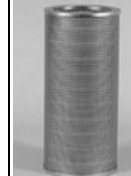

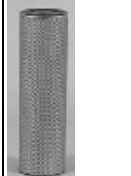





















E. PRODUCT GUIDE

HF6247  LIEBHERR 7360470 Overall Height: 18.07 (459) Overall OD: 3.92 (100) End 1 ID: 2.48 (63) End 2 ID: 1.89 (48)	HF6255  GRESEN FST1201R0, ZINGA SS2000 Overall Height: 10.04 (255) Overall OD: 3.94 (100) End 1 ID: 2.25 (57)	HF6265  GRESEN FST1251RX, ZINGA SS2503 Overall Height: 10.10 (257) Overall OD: 5.12 (130) BPV Setting: 3.05 (21) End 1 ID: 2.68 (68)
HF6248  LIEBHERR 7211191 Overall Height: 13.66 (347) Overall OD: 3.92 (100) End 1 ID: 2.48 (63) End 2 ID: 1.89 (48)	HF6257  GRESEN FST1311R0, ZINGA SS3000 Overall Height: 11.81 (300) Overall OD: 5.06 (129) End 1 ID: 3.25 (83)	HF6266  GRESEN FST1311RX, ZINGA SS3003 Overall Height: 11.88 (302) Overall OD: 5.06 (129) BPV Setting: 3.05 (21) End 1 ID: 3.30 (84)
HF6249  GRESEN FST1051R0 Overall Height: 3.07 (78) Overall OD: 2.63 (67) End 1 ID: 0.72 (18)	HF6259  GRESEN FST1071RX, ZINGA SS0703 Overall Height: 2.53 (64) Overall OD: 2.62 (67) BPV Setting: 3.05 (21) End 1 ID: 0.93 (24)	HF6267  KHD(KLOCKNER-HUMBOLDT-DEUTZ) 4305722 Overall Height: 8.27 (210) Largest OD: 3.68 (94) BPV Setting: 36.26 (250) Thread Size: 1-12 UNF-2B
HF6250  GRESEN FST1071R0 Overall Height: 3.50 (89) Overall OD: 2.63 (67) End 1 ID: 0.93 (23)	HF6260  GRESEN FST1101RX, ZINGA SS1003 Overall Height: 5.35 (136) Overall OD: 2.63 (67) BPV Setting: 3.05 (21) End 1 ID: 1.15 (29)	HF6268  FIAT-ALLIS 1909106 Overall Height: 8.23 (209) Overall OD: 3.35 (85) BPV Setting: 14.50 (100) End 1 ID: 1.38 (35)
HF6251  GRESEN FST1101R0, ZINGA SS1000 1 inch NPTF threads Overall Height: 5.35 (136) Overall OD: 2.63 (67) End 1 ID: 1.15 (29)	HF6261  GRESEN FST1121RX, ZINGA SS1203 Overall Height: 6.81 (173) Overall OD: 3.36 (85) BPV Setting: 3.05 (21) End 1 ID: 1.50 (38)	HF6269  INGERSOLL-RAND 35296920 Overall Height: 8.72 (221) Largest OD: 3.73 (95) Thread Size: 1 1/4-12 UNF-2B
HF6252  GRESEN FST1121R0, ZINGA SS1200 Overall Height: 6.85 (174) Overall OD: 3.38 (86) End 1 ID: 1.51 (38)	HF6262  GRESEN FST1151RX, CAN-FLO CFSE301003 Overall Height: 8.00 (203) Overall OD: 3.36 (85) BPV Setting: 3.05 (21) End 1 ID: 1.73 (44)	HF6270  Uses service part: 3832879S Upgrade of HF6373 Microglass Version of HF6118 Gasket: 322951, 333639, 3836102 Overall Height: 8.93 (227) Overall OD: 4.51 (115) End 1 ID: 1.44 (37)
HF6253  GRESEN FST1151R0, CAN-FLO CFSE30100 Overall Height: 8.05 (204) Overall OD: 3.38 (86) End 1 ID: 1.75 (44)	HF6263  ZINGA SS1503, CAN-FLO CFSE401003 Overall Height: 9.75 (248) Overall OD: 3.91 (99) BPV Setting: 3.05 (21) End 1 ID: 1.74 (44)	HF6271  Uses service part: 3832879S Upgrade of HF6118 For Upgrade, use HF6373 Gasket: 322951, 3836102 Overall Height: 8.93 (227) Overall OD: 4.51 (115) End 1 ID: 1.44 (37)
HF6254  ZINGA SS1500, CAN-FLO CFSE40100 Overall Height: 10.04 (255) Overall OD: 3.94 (100) End 1 ID: 1.38 (35)	HF6264  GRESEN FST1201RX, ZINGA SS2003 Overall Height: 10.04 (255) Overall OD: 3.94 (100) BPV Setting: 3.05 (21) End 1 ID: 2.25 (57)	HF6272  POCLAIN H1050532 For Synthetic Media Version use HF7957 Overall Height: 12.99 (330) Overall OD: 7.99 (203) End 1 ID: 0.51 (13) End 2 ID: 6.18 (157)

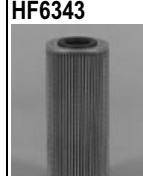

E. PRODUCT GUIDE

HF6273  FAIREY ARLON FX110 Overall Height: 11.81 (300) Overall OD: 2.84 (72) End 1 ID: 2.05 (52)	HF6296  DONALDSON P160700 Overall Height: 16.00 (406) Overall OD: 4.39 (112) End 1 ID: 2.44 (62)	HF6307  FAIREY ARLON TXX3D10 Overall Height: 7.87 (200) Overall OD: 2.84 (72) End 1 ID: 0.28 (7) End 2 ID: 2.05 (52)
HF6274  FIAT-ALLIS 74975589 Overall Height: 8.11 (206) Overall OD: 1.77 (45) End 1 ID: 0.98 (25)	HF6297  DONALDSON P161571 Overall Height: 16.00 (406) Overall OD: 4.38 (111) End 1 ID: 2.43 (62)	HF6308  FAIREY ARLON TXX410 Cellulose Media. For Synthetic Media Version use HF7959. Overall Height: 7.48 (190) Overall OD: 4.17 (106) End 1 ID: 0.35 (9) End 2 ID: 2.84 (72)
HF6276  FORD D8NNB951AE Overall Height: 7.44 (189) Overall OD: 4.63 (118) End 1 ID: 2.23 (57)	HF6298  DONALDSON P161917 Overall Height: 13.00 (330) Overall OD: 4.39 (112) End 1 ID: 2.44 (62)	HF6309  FAIREY ARLON TXX5A10 For Upgrade, use HF7961 Overall Height: 18.31 (465) Overall OD: 4.17 (106) End 1 ID: 0.35 (9) End 2 ID: 2.84 (72)
HF6278  ZF 7633141110 Overall Height: 4.57 (116) Overall OD: 2.17 (55) End 1 ID: 0.51 (13)	HF6301  LIEBHERR 7211188 Overall Height: 24.57 (624) Overall OD: 5.98 (152) End 1 ID: 3.47 (88) End 2 ID: 1.87 (48)	HF6310  FAIREY ARLON TXX8B10 For Synthetic Media Version use HF7958 Overall Height: 15.35 (390) Overall OD: 4.96 (126) End 1 ID: 0.35 (9) End 2 ID: 3.62 (92)
HF6279  FORD D8NNF933AB Overall Height: 6.65 (169) Largest OD: 3.73 (95) BPV Setting: 17.40 (120) Thread Size: 1-12 UNF-2B	HF6302  SAME 24419210110, CARRARO 109617 Overall Height: 8.23 (209) Overall OD: 3.35 (85) End 1 ID: 1.38 (35)	HF6311  FAIREY ARLON TXX8C10 For Synthetic Media Version use HF7964 Overall Height: 18.90 (480) Overall OD: 4.96 (126) End 1 ID: 0.35 (9) End 2 ID: 3.62 (92)
HF6280  FORD D5NNF933A Overall Height: 6.67 (170) Largest OD: 3.86 (98) BPV Setting: 20.30 (140) Thread Size: 1-12 UNF-2B	HF6303  LETOURNEAU-WESTINGHOUSE 727076 Overall Height: 7.00 (178) Overall OD: 4.52 (115) End 1 ID: 1.77 (45)	HF6312  FAIREY ARLON TXX1110 For Synthetic Media Version of HF7965 Overall Height: 17.32 (440) Overall OD: 7.99 (203) End 1 ID: 0.51 (13) End 2 ID: 6.18 (157)
HF6281  JOHN DEERE RE27284 Microglass Filter Gasket: 333269 Overall Height: 5.83 (148) Largest OD: 3.74 (95) Thread Size: 1 1/2-16 UN-2B	HF6305  MITSUBISHI 68937001001 Overall Height: 14.88 (378) Overall OD: 4.46 (113) End 1 ID: 2.83 (72)	HF6313  FAIREY ARLON TXX1210 For Synthetic Media Version use HF7966 Overall Height: 21.46 (545) Overall OD: 7.99 (203) End 1 ID: 0.51 (13) End 2 ID: 6.18 (157)
HF6284  DONALDSON P160205 Overall Height: 5.00 (127) Overall OD: 4.38 (111) End 1 ID: 2.44 (62)	HF6306  FAIREY ARLON TXX310 Overall Height: 5.91 (150) Overall OD: 2.84 (72) End 1 ID: 0.28 (7) End 2 ID: 2.05 (52)	HF6314  FAIREY ARLON TXX1310 For Synthetic Media Version use HF7967 Overall Height: 32.48 (825) Overall OD: 7.99 (203) End 1 ID: 0.51 (13) End 2 ID: 6.18 (157)























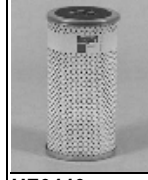

E. PRODUCT GUIDE

<p>HF6315 BOMAG 5821203</p>  <p>Overall Height: 5.61 (143) Largest OD: 3.68 (94) BPV Setting: 36.26 (250) Thread Size: 3/4-16 UNF-2B</p>	<p>HF6323 FIAT-ALLIS 79034045</p>  <p>Overall Height: 10.35 (263) Overall OD: 3.92 (100) End 1 ID: 2.46 (63) End 2 ID: 0.39 (10)</p>	<p>HF6333 VICKERS 736426, DONALDSON P551238 Not available in all parts of the world.</p>  <p>Overall Height: 3.00 (76) Overall OD: 2.61 (66) End 1 ID: 1.01 (26)</p>
<p>HF6316 ZF 750131012</p>  <p>Overall Height: 5.61 (143) Largest OD: 3.68 (94) BPV Setting: 36.26 (250) Thread Size: M24 X 1.5-6H INT</p>	<p>HF6324 HANOMAG-HENSCHEL 373952178, MANN & HUMMEL H12901</p>  <p>Overall Height: 6.58 (167) Overall OD: 4.65 (118) End 1 ID: 2.32 (59)</p>	<p>HF6337 CATERPILLAR 4T7948</p>  <p>Overall Height: 4.59 (117) Largest OD: 3.68 (94) Standpipe: YES BPV Setting: 17.40 (120) Thread Size: 13/16-16 UN-2B</p>
<p>HF6317 ZF 750131013</p>  <p>Overall Height: 8.29 (211) Largest OD: 3.68 (94) BPV Setting: 36.26 (250) Thread Size: M24 X 1.5-6H EXT</p>	<p>HF6325 CATERPILLAR 5W5803</p>  <p>Overall Height: 6.58 (167) Overall OD: 4.65 (118) End 1 ID: 2.32 (59)</p>	<p>HF6338 JOHN DEERE AT120444, LHA MACDONMPE402 Filter used with HH6952</p>  <p>Gasket: 333269 Overall Height: 8.00 (203) Largest OD: 3.75 (95) Thread Size: 1 1/2-16 UN-2B</p>
<p>HF6318 Filter used with 3314849S Upgrade of HF6243</p>  <p>Gasket: 3832864 Overall Height: 10.30 (261) Largest OD: 4.67 (119) Thread Size: 1 5/16-12 UNS-2B</p>	<p>HF6326 UCC HYDRAULICS UC2418</p>  <p>Overall Height: 6.93 (176) Largest OD: 5.12 (130) BPV Setting: 14.50 (100) Thread Size: 1 1/4 BSP</p>	<p>HF6339 CATERPILLAR 4T3133 Upgrade of HF6083</p>  <p>Overall Height: 9.12 (232) Overall OD: 6.83 (173) End 1 ID: 3.94 (100)</p>
<p>HF6319 KOMATSU 2056051430 For Upgrade, use HF28978</p>  <p>Overall Height: 17.75 (451) Overall OD: 5.91 (150) End 1 ID: 4.33 (110)</p>	<p>HF6327 FAIREY ARLON 4A110</p>  <p>Gasket: 3322164 Overall Height: 7.48 (190) Largest OD: 5.08 (129) Thread Size: 1 1/2 BSP</p>	<p>HF6341 CATERPILLAR 4T3131 Upgrade of HF6097</p>  <p>Overall Height: 9.37 (238) Overall OD: 3.99 (101) End 1 ID: 2.30 (58)</p>
<p>HF6320 CLARK 244530, NEW HOLLAND 71004922, CASE S300744</p>  <p>Gasket: 3842592 Overall Height: 5.61 (142) End 1 OD: 3.49 (89) End 2 OD: 3.48 (88) End 2 ID: 1.14 (29)</p>	<p>HF6328 FAIREY ARLON 4A210</p>  <p>Gasket: 3322164 Overall Height: 7.48 (190) Largest OD: 5.08 (129) BPV Setting: 7.25 (50) Thread Size: 1 1/2 BSP</p>	<p>HF6342 CATERPILLAR 4T3132 Upgrade of HF6098</p>  <p>Overall Height: 9.12 (232) Overall OD: 5.10 (130) End 1 ID: 3.35 (85)</p>
<p>HF6321 FIAT-ALLIS 78253660</p>  <p>Overall Height: 12.17 (309) Overall OD: 4.13 (105) End 1 ID: 1.99 (51) End 2 ID: 1.97 (50)</p>	<p>HF6329 CROSLAND 7512A</p>  <p>Gasket: 3322164 Overall Height: 7.48 (190) Largest OD: 5.08 (129) BPV Setting: 14.50 (100) Thread Size: 1 1/2 BSP</p>	<p>HF6343 PARKER 925779, SCHROEDER KS7 Upgrade of HF6110</p>  <p>Overall Height: 9.23 (234) Overall OD: 3.93 (100) End 1 ID: 1.61 (41)</p>
<p>HF6322 FIAT-ALLIS 78280891, FIAT-ALLIS 70599514</p>  <p>Overall Height: 12.05 (306) Overall OD: 3.43 (87) End 1 ID: 2.01 (51) End 2 ID: 1.99 (51)</p>	<p>HF6330 FIAT-ALLIS 74978765, FIAT-ALLIS 79006732</p>  <p>Overall Height: 9.45 (240) Overall OD: 5.91 (150) End 1 ID: 3.27 (83)</p>	<p>HF6344 CATERPILLAR 4T3134 Uses service part: 3838228S Upgrade of HF6202</p>  <p>Gasket: 3838228 (1)¹⁰ Overall Height: 11.12 (282) Overall OD: 5.10 (130) End 1 ID: 3.35 (85)</p>



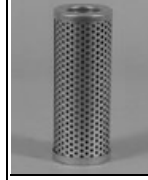







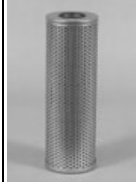
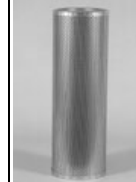

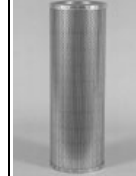

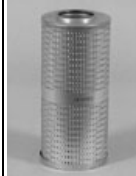





E. PRODUCT GUIDE

HF6348  CASE A169652 Upgrade of HF6140 Microglass Version Gasket: 3312097 ¹⁰ , 332418 Overall Height: 10.71 (272) Largest OD: 5.08 (129) BPV Setting: 22.04 (152) Thread Size: 1 1/2-16 UN-2B	HF6357  TORO 678110 Overall Height: 4.57 (116) Largest OD: 3.73 (95) Thread Size: 1-12 UNF-2B	HF6368  TIMBERJACK 205882 Overall Height: 9.12 (232) Overall OD: 5.12 (130) End 1 ID: 3.36 (85) End 2 ID: 0.40 (10)
HF6349  SAME 244192602 Overall Height: 8.54 (217) Largest OD: 3.68 (94) Thread Size: 1-14 UNS-2B	HF6358  CHAMPION ROAD MACH. 13028 Gasket: 3833451 Overall Height: 6.71 (170) Largest OD: 5.08 (129) Thread Size: 1 1/2-16 UN-2B	HF6369  CASE 573201R1 Overall Height: 4.44 (113) Overall OD: 1.75 (44) End 1 ID: 1.00 (25)
HF6350  SAME 244192800 Overall Height: 9.00 (229) Largest OD: 4.25 (108) Thread Size: M40 X 2-6H INT	HF6359  LIEBHERR 7010930, CASE 1966553C1 Overall Height: 9.09 (231) Largest OD: 5.20 (132) Thread Size: 1 1/4 BSP	HF6373  Upgrade of HF6271 For Upgrade, use HF6270 Microglass Version of HF6118 Gasket: 322951, 333639, 3836102 Overall Height: 8.93 (227) Overall OD: 4.51 (115) End 1 ID: 1.44 (37)
HF6351  HYSTER 297865 Overall Height: 5.61 (143) Largest OD: 3.68 (94) ADBV: Yes BPV Setting: 23.21 (160) Thread Size: 3/4-16 UNF-2B	HF6360  JOHN DEERE AL56469 Overall Height: 6.87 (175) Largest OD: 3.68 (94) Thread Size: 1-12 UNF-2B	HF6376  CATERPILLAR 4T0522 Overall Height: 7.00 (178) Overall OD: 5.07 (129) End 1 ID: 3.34 (85)
HF6352  HYSTER 309112 Overall Height: 4.59 (117) Largest OD: 3.68 (94) ADBV: Yes BPV Setting: 9.43 (65) Thread Size: 3/4-16 UNF-2B	HF6361  M.A.N. 81331180007 Overall Height: 5.61 (143) Largest OD: 3.68 (94) BPV Setting: 36.26 (250) Thread Size: 1-12 UNF-2B	HF6386  ARMY-NAVY AN62351A Overall Height: 1.88 (48) Overall OD: 0.83 (21) End 1 ID: 0.38 (10)
HF6353  MANN & HUMMEL H151906N Overall Height: 15.00 (381) Overall OD: 5.91 (150) End 1 ID: 1.20 (31)	HF6365  CATERPILLAR 2P5834 Overall Height: 5.65 (144) End 1 OD: 2.97 (75) End 2 OD: 2.90 (74) End 1 ID: 1.04 (26)	HF6387  ARMY-NAVY AN62352A Overall Height: 4.63 (117) Overall OD: 1.13 (29) End 1 ID: 0.63 (16)
HF6354  KOMATSU 706301054 For Upgrade, use HF28979 Overall Height: 8.26 (210) Overall OD: 3.94 (100) End 1 ID: 2.33 (59)	HF6366  CLARK 2366807 Overall Height: 6.90 (175) Largest OD: 3.72 (94) Thread Size: 2-16 UNS-2B	HF6388  ARMY-NAVY AN62353A Overall Height: 3.44 (87) Overall OD: 1.63 (41) End 1 ID: 0.88 (22)
HF6356  KOMATSU 1956016320 For Upgrade, use HF28975 Overall Height: 11.81 (300) Overall OD: 5.91 (150) End 1 ID: 4.33 (110) End 2 ID: 4.33 (110)	HF6367  MARVEL 6763865140 Not available in all parts of the world. Overall Height: 7.41 (188) Overall OD: 4.49 (114) End 1 ID: 2.36 (60)	HF6389  DDA 23040988 Overall Height: 8.22 (209) End 1 OD: 3.26 (83) End 2 OD: 3.21 (81) End 1 ID: 1.51 (38)

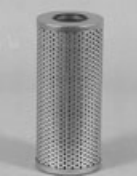



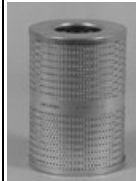















E. PRODUCT GUIDE

<p>HF6392 VICKERS 922788</p>  <p>Gasket: 318037 Overall Height: 4.47 (114) Overall OD: 2.90 (74) End 1 ID: 1.12 (28) End 2 ID: 0.49 (12)</p>	<p>HF6418 WHITE 3107499</p>  <p>Overall Height: 5.12 (130) Overall OD: 3.93 (100) End 1 ID: 1.07 (27)</p>	<p>HF6434 JOHN DEERE AT147821</p>  <p>Gasket: 3913068S¹⁰ Overall Height: 6.00 (152) Overall OD: 1.98 (50) End 1 ID: 0.92 (23)</p>
<p>HF6393 CATERPILLAR 9W2932</p>  <p>Overall Height: 9.37 (238) Overall OD: 3.99 (101) End 1 ID: 2.30 (58)</p>	<p>HF6420 CLARK 234099</p>  <p>Overall Height: 5.61 (143) Largest OD: 3.68 (94) BPV Setting: 23.21 (160) Thread Size: 2-16 UN-2B</p>	<p>HF6435 JOHN DEERE AT147822</p>  <p>Overall Height: 8.07 (205) Largest OD: 4.28 (109) Thread Size: 1 1/8-16 UN-2B</p>
<p>HF6394 CASE A39578</p>  <p>Overall Height: 6.01 (153) Overall OD: 2.33 (59) End 1 ID: 1.36 (35)</p>	<p>HF6421 VME (VOLVO BM/MICH/EUCLID) 2560232</p>  <p>Overall Height: 18.15 (461) Overall OD: 7.44 (189) End 1 ID: 4.85 (123)</p>	<p>HF6436 DONALDSON P167226</p>  <p>Gasket: 3839901 Overall Height: 8.96 (228) Largest OD: 5.08 (129) Thread Size: 1 1/2-16 UN-2B</p>
<p>HF6399 JOHN DEERE AT127608, JOHN DEERE AT147343, LUBERFINER LH8488</p>  <p>Gasket: 3839550 Overall Height: 17.88 (454) Overall OD: 5.91 (150) End 1 ID: 4.33 (110)</p>	<p>HF6423 Various Hydraulic Applications</p>  <p>Overall Height: 5.77 (147) Largest OD: 3.72 (95) Thread Size: .970-20 UNS-2B</p>	<p>HF6439 VICKERS 736820 Not available in all parts of the world.</p>  <p>Overall Height: 6.71 (170) Largest OD: 5.08 (129) Thread Size: 1 1/2-16 UN-2B</p>
<p>HF6406 VICKERS 737933</p>  <p>Overall Height: 8.20 (208) End 1 OD: 3.12 (79) End 2 OD: 3.11 (79)</p>	<p>HF6424 Various Hydraulic Applications</p>  <p>Overall Height: 5.77 (147) Largest OD: 3.72 (94) BPV Setting: 30.17 (208) Thread Size: .970-20 UNS-2B</p>	<p>HF6440 CLARK 801851</p>  <p>Gasket: 317237, 322951, 329728, 3836102 Overall Height: 8.91 (226) Overall OD: 4.51 (115) End 1 ID: 1.44 (37)</p>
<p>HF6411 VICKERS 737562 Not available in all parts of the world.</p>  <p>Overall Height: 9.23 (234) Overall OD: 3.94 (100) End 1 ID: 1.61 (41)</p>	<p>HF6428 VICKERS 737546 Not available in all parts of the world.</p>  <p>Overall Height: 4.20 (107) End 1 OD: 3.12 (79) End 2 OD: 3.11 (79) End 2 ID: 1.67 (42)</p>	<p>HF6446 JOHN DEERE AET10401 Upgrade of HF6164 Microglass Version</p>  <p>Overall Height: 3.84 (98) Largest OD: 3.69 (94) Thread Size: 3/4-16 UNF-2B</p>
<p>HF6413 VICKERS 737582</p>  <p>Overall Height: 9.23 (234) Overall OD: 3.93 (100) End 1 ID: 1.61 (41)</p>	<p>HF6429 VICKERS 737547</p>  <p>Overall Height: 8.16 (207) Overall OD: 3.11 (79) End 1 ID: 1.67 (42)</p>	<p>HF6447 DONALDSON P162955</p>  <p>Overall Height: 8.00 (203) Overall OD: 3.10 (79) End 1 ID: 1.74 (44)</p>
<p>HF6417 DYNAHOE 499519</p>  <p>Overall Height: 8.29 (211) Largest OD: 3.68 (94) Thread Size: 1-12 UNF-2B</p>	<p>HF6431 VICKERS 737549 Not available in all parts of the world.</p>  <p>Overall Height: 8.20 (208) End 1 OD: 3.12 (79) End 2 OD: 3.11 (79) End 2 ID: 1.66 (42)</p>	<p>HF6451 DONALDSON P164351</p>  <p>Overall Height: 8.76 (223) Largest OD: 3.69 (94) Thread Size: 1 1/4-12 UNF-2B</p>

























E. PRODUCT GUIDE

HF6456  DONALDSON P160555 Overall Height: 5.00 (127) Overall OD: 4.38 (111) End 1 ID: 2.44 (62)	HF6473  DONALDSON P161969 Overall Height: 13.00 (330) Overall OD: 4.38 (111) End 1 ID: 1.86 (47)	HF6491  DONALDSON P160225 Overall Height: 22.00 (559) Overall OD: 7.44 (189) End 1 ID: 4.84 (123)
HF6457  CASE 70203C2 Overall Height: 5.83 (148) Largest OD: 3.70 (94) Thread Size: 1-12 UNF-2B	HF6479  DONALDSON P162471 Overall Height: 16.00 (406) Overall OD: 4.38 (111) End 1 ID: 2.44 (62)	HF6493  DONALDSON P161015 Overall Height: 22.00 (559) Overall OD: 7.44 (189) End 1 ID: 4.85 (123)
HF6459  DONALDSON P160696 Overall Height: 8.00 (203) Overall OD: 4.38 (111) End 1 ID: 2.44 (62)	HF6481  DONALDSON P165314 Overall Height: 9.72 (247) Overall OD: 4.48 (114) End 1 ID: 2.30 (58)	HF6500  PARKER 926542B, PARKER 926543 Overall Height: 5.76 (146) Largest OD: 3.72 (94) Thread Size: 1-12 UNF-2B
HF6461  DONALDSON P165251 Overall Height: 8.00 (203) Overall OD: 4.38 (111) End 1 ID: 1.98 (50)	HF6482  DONALDSON P165231 Overall Height: 5.47 (139) Overall OD: 4.61 (117) End 1 ID: 2.19 (56)	HF6502  ZINGA AE25 Overall Height: 5.82 (148) Largest OD: 3.72 (94) Thread Size: 1-12 UNF-2B
HF6464  DONALDSON P163172 Overall Height: 8.00 (203) Overall OD: 4.38 (111) End 1 ID: 2.44 (62)	HF6483  DONALDSON P164906 Overall Height: 7.97 (202) Overall OD: 4.61 (117) End 1 ID: 2.19 (56)	HF6504  PARKER 929323 Uses service part: 3313095S Overall Height: 5.81 (148) Largest OD: 3.72 (94) Thread Size: 1-12 UNF-2B
HF6465  DONALDSON P161413 Overall Height: 8.00 (203) Overall OD: 4.38 (111) End 1 ID: 2.44 (62)	HF6484  DONALDSON P160419 Overall Height: 10.49 (266) Largest OD: 5.00 (127) Thread Size: 3-16 UN-2B	HF6505  FAIREY ARLON FA35CC10, STAUFF SF6505MG, STAUFF SF6505 Uses service part: 3313095S Overall Height: 5.82 (148) Largest OD: 3.72 (94) Thread Size: 1-12 UNF-2B
HF6467  DONALDSON P161908 Overall Height: 10.10 (257) Overall OD: 4.38 (111) End 1 ID: 1.86 (47)	HF6485  DONALDSON P165242, NEW HOLLAND 73125853 Overall Height: 9.00 (229) Overall OD: 5.07 (129) End 1 ID: 3.34 (85)	HF6510  General Usage Overall Height: 5.76 (146) Largest OD: 3.72 (94) Thread Size: 1-12 UNF-2B
HF6470  DONALDSON P165507 Overall Height: 13.00 (330) Overall OD: 4.38 (111) End 1 ID: 2.44 (62)	HF6486  DONALDSON P165233 Overall Height: 7.83 (199) Overall OD: 5.51 (140) End 1 ID: 2.63 (67)	HF6511  LHA SPE2510 Overall Height: 8.09 (205) Largest OD: 3.72 (94) Thread Size: 1-12 UNF-2B

























E. PRODUCT GUIDE

<p>HF6517 CASE A165029</p>  <p>Overall Height: 6.05 (154) Largest OD: 3.95 (100) Thread Size: 1 3/8-12 UNF-2B</p>	<p>HF6535 CIM-TEK 70184</p> <p>Overall Height: 5.77 (147) Largest OD: 3.72 (94) Thread Size: 3/4-14 BSP</p>	<p>HF6550 DONALDSON P165354</p>  <p>Overall Height: 6.05 (154) Largest OD: 3.95 (100) Thread Size: 1 3/8-12 UNF-2B</p>
<p>HF6518 DYNAPAC 372229 Upgrade of HF6578</p>  <p>Overall Height: 9.45 (240) Largest OD: 3.95 (100) Thread Size: 1 3/8-12 UNF-2B</p>	<p>HF6536</p>  <p>Overall Height: 8.09 (205) Largest OD: 3.72 (94) Thread Size: 3/4-14 BSP</p>	<p>HF6551 DONALDSON P165332</p>  <p>Overall Height: 9.45 (240) Largest OD: 3.95 (100) Thread Size: 1 3/8-12 UNF-2B</p>
<p>HF6520 PARKER 925023B, PARKER 925947</p>  <p>Overall Height: 5.76 (146) Largest OD: 3.72 (94) Thread Size: 1-12 UNF-2B</p>	<p>HF6538 MP FILTRI CS070P25A</p> <p>Overall Height: 8.09 (205) Largest OD: 3.72 (94) Thread Size: 3/4-14 BSP</p>	<p>HF6552 DONALDSON P164375</p>  <p>Overall Height: 6.05 (154) Largest OD: 3.95 (100) Thread Size: 1 3/8-12 UNF-2B</p>
<p>HF6521 INGERSOLL-RAND 59026500</p>  <p>Overall Height: 8.09 (205) Largest OD: 3.72 (94) Thread Size: 1-12 UNF-2B</p>	<p>HF6539 MP FILTRI CS050A03A</p>  <p>Overall Height: 5.77 (147) Largest OD: 3.72 (94) Thread Size: 3/4-14 BSP</p>	<p>HF6553 DONALDSON P164378</p>  <p>Overall Height: 9.45 (240) Largest OD: 3.95 (100) Thread Size: 1 3/8-12 UNF-2B</p>
<p>HF6522 DONALDSON P550274, DONALDSON P168431 Stainless Steel Mesh</p>  <p>Overall Height: 5.76 (146) Largest OD: 3.72 (94) Thread Size: 1-12 UNF-2B</p>	<p>HF6540 MP FILTRI CS070A03A</p> <p>Overall Height: 8.09 (205) Largest OD: 3.72 (94) Thread Size: 3/4-14 BSP</p>	<p>HF6554 DONALDSON P164381, VAPORMATIC CPK1528</p>  <p>Overall Height: 6.05 (154) Largest OD: 3.95 (100) Thread Size: 1 3/8-12 UNF-2B</p>
<p>HF6523 DONALDSON P551233 Stainless Steel Mesh</p>  <p>Overall Height: 8.09 (205) Largest OD: 3.72 (94) Thread Size: 1-12 UNF-2B</p>	<p>HF6541 HYDAC 80MG10BN</p> <p>Overall Height: 5.77 (147) Largest OD: 3.72 (94) Thread Size: 3/4-14 BSP</p>	<p>HF6555 CASE N9025</p>  <p>Overall Height: 9.45 (240) Largest OD: 3.95 (100) Thread Size: 1 3/8-12 UNF-2B</p>
<p>HF6527 AP LOCKHEED APWC12239</p>  <p>Overall Height: 5.55 (141) Overall OD: 2.58 (66) End 1 ID: 1.34 (34)</p>	<p>HF6542 MP FILTRI CS070A10</p> <p>Overall Height: 8.09 (205) Largest OD: 3.72 (94) Thread Size: 3/4-14 BSP</p>	<p>HF6556 DONALDSON P165335</p>  <p>Overall Height: 6.05 (154) Largest OD: 3.95 (100) Thread Size: 1 3/8-12 UNF-2B</p>
<p>HF6532 NEW HOLLAND 86597474, JOHN DEERE RE17380, DONALDSON P551234</p>  <p>Overall Height: 5.73 (146) Largest OD: 3.72 (94) Thread Size: 1-12 UNF-2B</p>	<p>HF6544 MP FILTRI CS070A25A</p> <p>Overall Height: 8.09 (205) Largest OD: 3.72 (94) Thread Size: 3/4-14 BSP</p>	<p>HF6557 DONALDSON P165338</p>  <p>Overall Height: 9.45 (240) Largest OD: 3.95 (100) Thread Size: 1 3/8-12 UNF-2B</p>
	<p>HF6546 NEW HOLLAND 9706161</p>  <p>Overall Height: 7.70 (196) Largest OD: 4.79 (122) Thread Size: 1 3/4-12 UN-2B</p>	
	<p>HF6547 NEW HOLLAND 85802793</p>  <p>Overall Height: 11.59 (294) Largest OD: 4.79 (122) Thread Size: 1 3/4-12 UN-2B</p>	
	<p>HF6549 STAUFF SF6549MG, SCHROEDER PZ10, STAUFF SF6549</p>  <p>Overall Height: 5.82 (148) Largest OD: 3.72 (95) Thread Size: 1-12 UNF-2B</p>	























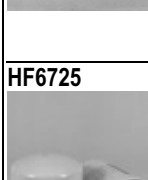

E. PRODUCT GUIDE

HF6560  DONALDSON P163405 Overall Height: 6.05 (154) Largest OD: 3.95 (100) Thread Size: 1 3/8-12 UNF-2B	HF6572  DONALDSON P163542 Overall Height: 6.05 (154) Largest OD: 3.95 (100) Thread Size: 1 3/8-12 UNF-2B	HF6581  PICANOL B50274 Not available in all parts of the world. Overall Height: 8.27 (210) Largest OD: 3.68 (94) Thread Size: 1-12 UNF-2B
HF6561  DONALDSON P163323 Overall Height: 9.45 (240) Largest OD: 3.95 (100) Thread Size: 1 3/8-12 UNF-2B	HF6573  DONALDSON P163555 Overall Height: 9.45 (240) Largest OD: 3.95 (100) Thread Size: 1 3/8-12 UNF-2B	HF6583  General Usage Overall Height: 5.82 (148) Largest OD: 3.72 (94) Thread Size: 1-12 UNF-2B
HF6562  DONALDSON P163412 Overall Height: 6.05 (154) Largest OD: 3.95 (100) Thread Size: 1 3/8-12 UNF-2B	HF6574  DONALDSON P163315 Overall Height: 6.05 (154) Largest OD: 3.95 (100) Thread Size: 1 3/8-12 UNF-2B	HF6585  INGERSOLL-RAND 36860336 Overall Height: 11.53 (293) Largest OD: 4.79 (122) Thread Size: 1 3/4-12 UN-2B
HF6563  CASE D126922 Overall Height: 9.45 (240) Largest OD: 3.95 (100) Thread Size: 1 3/8-12 UNF-2B	HF6575  DONALDSON P163567 Overall Height: 9.45 (240) Largest OD: 3.95 (100) Thread Size: 1 3/8-12 UNF-2B	HF6586  CATERPILLAR 9T0973 Gasket: 3837402 Overall Height: 11.59 (294) Largest OD: 4.79 (122) Thread Size: 1 3/4-12 UN-2B
HF6565  DONALDSON P163324 Overall Height: 9.45 (240) Largest OD: 3.95 (100) Thread Size: 1 3/8-12 UNF-2B	HF6576  DONALDSON P163561 Overall Height: 9.45 (240) Largest OD: 3.95 (100) Thread Size: 1 3/8-12 UNF-2B	HF6587  CASE N9086, DONALDSON P165659 Gasket: 3837402 Overall Height: 11.59 (294) Largest OD: 4.79 (122) Thread Size: 1 3/4-12 UN-2B
HF6566  DONALDSON P163496 Overall Height: 6.05 (154) Largest OD: 3.95 (100) Thread Size: 1 3/8-12 UNF-2B	HF6577  DONALDSON P163558 Overall Height: 9.45 (240) Largest OD: 3.95 (100) Thread Size: 1 3/8-12 UNF-2B	HF6588  DONALDSON P165675 Gasket: 3837402 Overall Height: 11.59 (294) Largest OD: 4.79 (122) Thread Size: 1 3/4-12 UN-2B
HF6568  DONALDSON P163428 Overall Height: 6.05 (154) Largest OD: 3.95 (100) Thread Size: 1 3/8-12 UNF-2B	HF6578  DONALDSON P163546 For Upgrade, use HF6518 Synthetic media version of the HF6577 Overall Height: 9.45 (240) Largest OD: 3.95 (100) Thread Size: 1 3/8-12 UNF-2B	HF6591  MP PRODUCTS CS50A25A Overall Height: 5.77 (147) Largest OD: 3.72 (94) Thread Size: 3/4-14 BSP
HF6569  DONALDSON P163425, CASE L36242 Overall Height: 9.45 (240) Largest OD: 3.95 (100) Thread Size: 1 3/8-12 UNF-2B	HF6579  JOHN DEERE AT147496 Filter used with HH6952 Overall Height: 9.50 (241) Largest OD: 3.95 (100) Thread Size: 1 1/2-16 UN-2B	HF6600  PALL HC7400SUK4H, CASE 137939C1 Uses service part: 3830110S Gasket: 333269 Overall Height: 5.83 (148) Largest OD: 3.74 (95) Thread Size: 1 1/2-16 UN-2B

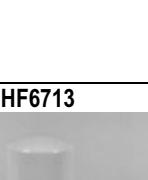











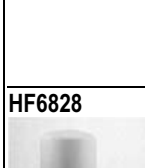







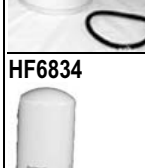

E. PRODUCT GUIDE

HF6601  FUNK 4003058, CASE 561980C1 Gasket: 333269 Overall Height: 8.03 (204) Largest OD: 3.74 (95) Thread Size: 1 1/2-16 UN-2B	HF6613  PALL HC7400SDS8H Gasket: 333269 Overall Height: 8.02 (204) Largest OD: 3.72 (94) Thread Size: 1 1/2-16 UN-2B	HF6633  DONALDSON P551325 Gasket: 333269 Overall Height: 8.00 (203) Largest OD: 3.72 (94) Thread Size: 1 1/2-16 UN-2B
HF6603  PALL HC7400SUP4H, INGERSOLL-RAND 575129311 Gasket: 333269 Overall Height: 5.82 (148) Largest OD: 3.72 (94) Thread Size: 1 1/2-16 UN-2B	HF6620  PALL HC7400SUJ4H Gasket: 333269 Overall Height: 5.83 (148) Largest OD: 3.74 (95) Thread Size: 1 1/2-16 UN-2B	HF6634  CASE 1282428C1 Gasket: 333269 Overall Height: 5.80 (147) Largest OD: 3.72 (95) Thread Size: 1 1/2-16 UN-2B
HF6604  PALL HC7400SDP8H Gasket: 333269 Overall Height: 8.02 (204) Largest OD: 3.72 (94) Thread Size: 1 1/2-16 UN-2B	HF6621  Pall HC7400FUJ8H Gasket: 333269 Overall Height: 8.00 (203) Largest OD: 3.72 (95) Thread Size: 1 1/2-16 UN-2B	HF6635  CASE 1272942C1 Gasket: 333269 Overall Height: 8.00 (203) Largest OD: 3.75 (95) Thread Size: 1 1/2-16 UN-2B
HF6606  PALL HC7400SUN4H Gasket: 333269 Overall Height: 5.82 (148) Largest OD: 3.72 (94) Thread Size: 1 1/2-16 UN-2B	HF6625  PALL HC7400SUT4H, DONALDSON P167830 General Usage Gasket: 333269 Overall Height: 5.82 (148) Largest OD: 3.72 (94) Thread Size: 1 1/2-16 UN-2B	HF6641  FUNK 4003483, KOMATSU 149661 Gasket: 3312917 Overall Height: 8.03 (204) Largest OD: 3.72 (95) Thread Size: 1 1/2-16 UN-2B
HF6607  PALL HC7400SDN8H Gasket: 333269 Overall Height: 8.02 (204) Largest OD: 3.72 (94) Thread Size: 1 1/2-16 UN-2B	HF6626  PALL HC7400SDT8H Gasket: 333269 Overall Height: 8.02 (204) Largest OD: 3.72 (94) Thread Size: 1 1/2-16 UN-2B	HF6684  CASE 1971728C1 Overall Height: 14.36 (365) Largest OD: 4.79 (122) Thread Size: 1 3/4-12 UN-2B
HF6610  JOHN DEERE AE37594, PALL HC7400SUJ4H Gasket: 333269 Overall Height: 5.81 (148) Largest OD: 3.72 (94) Thread Size: 1 1/2-16 UN-2B	HF6630  DONALDSON P551236, EAGLE PICHER 63374 Gasket: 333269 Overall Height: 5.83 (148) Largest OD: 3.74 (95) Thread Size: 1 1/2-16 UN-2B	HF6700  PALL HC7500SUK4H, CASE 123085C2 Uses service part: 3830114S Gasket: 3312097 ¹⁰ , 3314250 ¹²¹⁰ , 332418 Overall Height: 6.71 (170) Largest OD: 5.08 (129) Thread Size: 1 1/2-16 UN-2B
HF6611  CASE 1240900C1 Gasket: 331291 Overall Height: 8.03 (204) Largest OD: 3.74 (95) Thread Size: 1 1/2-16 UN-2B	HF6631  ZINGA ZHE10LP, EAGLE PICHER 63741, MUSTANG MFG. CO. 17035067, GEHL 17035067 Gasket: 333269 Overall Height: 8.00 (203) Largest OD: 3.72 (94) Thread Size: 1 1/2-16 UN-2B	HF6701  ZINGA LE3, PALL HC7500SUK8H, UFI ESF22NCA Gasket: 3312097 ¹⁰ , 3314250 ¹²¹⁰ , 332418 Overall Height: 10.71 (272) Largest OD: 5.08 (129) Thread Size: 1 1/2-16 UN-2B
HF6612  PALL HC7400SUS4H Gasket: 333269 Overall Height: 5.82 (148) Largest OD: 3.72 (94) Thread Size: 1 1/2-16 UN-2B	HF6632  DONALDSON P551237 Gasket: 333269 Overall Height: 5.83 (148) Largest OD: 3.74 (95) Thread Size: 1 1/2-16 UN-2B	HF6703  PALL HC7500SUP4H Uses service part: 3830114S Gasket: 3314250 ¹²¹⁰ , 332418, 3929251 Overall Height: 6.71 (170) Largest OD: 5.08 (129) Thread Size: 1 1/2-16 UN-2B













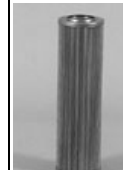

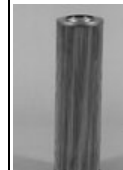



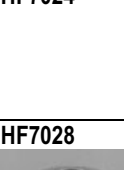

E. PRODUCT GUIDE

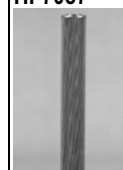
<p>HF6704</p>  <p>PALL HC7500SUP8H, ZINGA ZLE03P Uses service part: 3312097S, 3826177S, 3830114S</p> <p>Gasket: 332418, 3929251 Overall Height: 10.71 (272) Largest OD: 5.08 (129) Thread Size: 1 1/2-16 UN-2B</p>	<p>HF6718</p>  <p>Uses service part: 3929251, 3929251S</p> <p>Gasket: 3929251 Overall Height: 6.71 (170) Largest OD: 5.08 (129) Thread Size: 1 1/2-16 UN-2B</p>	<p>HF6730</p>  <p>ZINGA ZSE10</p> <p>Gasket: 3312097¹⁰, 3314250¹²¹⁰, 332418 Overall Height: 6.71 (170) Largest OD: 5.08 (129) Thread Size: 1 1/2-16 UN-2B</p>
<p>HF6706</p>  <p>PALL HC7500SUN4H Uses service part: 3830114S</p> <p>Gasket: 3314250¹²¹⁰, 332418, 3929251 Overall Height: 6.71 (170) Largest OD: 5.08 (129) Thread Size: 1 1/2-16 UN-2B</p>	<p>HF6720</p>  <p>ZINGA SE10, ZINGA SE10P, STAUFF SF6710 Uses service part: 3314250S Pall HC7500FUJ4H</p> <p>Gasket: 3312097¹⁰, 3314250¹²¹⁰, 332418 Overall Height: 6.71 (170) Largest OD: 5.08 (129) Thread Size: 1 1/2-16 UN-2B</p>	<p>HF6731</p>  <p>PARKER 929223, CASE H433531, ZINGA ZLE10, VICKERS V0211B2R10</p> <p>Gasket: 3312097¹⁰, 3314250¹²¹⁰, 332418 Overall Height: 10.71 (272) Largest OD: 5.08 (129) Thread Size: 1 1/2-16 UN-2B</p>
<p>HF6707</p>  <p>CASE H439069 Uses service part: 3830114S</p> <p>Gasket: 3314250¹²¹⁰, 332418, 3929251 Overall Height: 10.71 (272) Largest OD: 5.08 (129) Thread Size: 1 1/2-16 UN-2B</p>	<p>HF6721</p>  <p>PALL HC7500SUJ8H</p> <p>Gasket: 3312097¹⁰, 3314250¹⁰¹², 332418 Overall Height: 10.71 (272) Largest OD: 5.08 (129) Thread Size: 1 1/2-16 UN-2B</p>	<p>HF6732</p>  <p>CASE 1282387C2, FRAM P8020, JOHN DEERE AT135800</p> <p>Gasket: 3314250¹²¹⁰, 332418, 3929251 Overall Height: 6.71 (170) Largest OD: 5.08 (129) Thread Size: 1 1/2-16 UN-2B</p>
<p>HF6710</p>  <p>CATERPILLAR 9T5664</p> <p>Gasket: 3312097¹⁰, 3314250¹²¹⁰, 332418 Overall Height: 6.71 (170) Largest OD: 5.08 (129) Thread Size: 1 1/2-16 UN-2B</p>	<p>HF6722</p>  <p>DONALDSON P550275, ZINGA SE100, ZINGA SE100P Stainless Steel Mesh</p> <p>Gasket: 3312097¹⁰, 3314250¹²¹⁰, 332418 Overall Height: 6.71 (170) Largest OD: 5.08 (129) Thread Size: 1 1/2-16 UN-2B</p>	<p>HF6733</p>  <p>Uses service part: 3314250, 332418, 3929251, 3929251S General Usage</p> <p>Gasket: 3314250¹²¹⁰, 332418, 3929251 Overall Height: 10.71 (272) Largest OD: 5.08 (129) Thread Size: 1 1/2-16 UN-2B</p>
<p>HF6711</p>  <p>CASE A45625, CASE A143382, ZINGA LE25, VOLVO 12754597</p> <p>Gasket: 3312097¹⁰, 3314250¹²¹⁰, 332418 Overall Height: 10.71 (272) Largest OD: 5.08 (129) Thread Size: 1 1/2-16 UN-2B</p>	<p>HF6723</p>  <p>NEW HOLLAND 73133001, DONALDSON P550276, DONALDSON P168432, NORMAN EQUIPMENT 3536 Stainless Steel Mesh</p> <p>Gasket: 3312097¹⁰, 3314250¹²¹⁰, 332418 Overall Height: 10.71 (272) Largest OD: 5.08 (129) Thread Size: 1 1/2-16 UN-2B</p>	<p>HF6736</p>  <p>SCHROEDER M10</p> <p>Gasket: 3848303¹² Overall Height: 6.71 (170) Largest OD: 5.08 (129) Thread Size: 1 1/2-16 UN-2B</p>
<p>HF6712</p>  <p>NORMAN EQUIPMENT 512M, VAPORMATIC VPK1533, VICKERS V0211B1R10, BEHRINGER FLUID SYSTEMS, INC BS0128S12A38 Uses service part: 3830114S</p> <p>Gasket: 3314250¹²¹⁰, 332418, 3929251 Overall Height: 6.71 (170) Largest OD: 5.08 (129) Thread Size: 1 1/2-16 UN-2B</p>	<p>HF6725</p>  <p>PALL HC7500SUT4H, INGERSOLL-RAND 59873539 Uses service part: 3830114S</p> <p>Gasket: 3314250¹²¹⁰, 332418, 3929251 Overall Height: 6.71 (170) Largest OD: 5.08 (129) Thread Size: 1 1/2-16 UN-2B</p>	<p>HF6737</p>  <p>SCHROEDER MS7</p> <p>Gasket: 3848303¹², 3929251 Overall Height: 6.71 (170) Largest OD: 5.08 (129) Thread Size: 1 1/2-16 UN-2B</p>
<p>HF6713</p>  <p>PALL HC7500SUS8H, PUROLATOR H55136, NORMAN EQUIPMENT 612M, BEHRINGER FLUID SYSTEMS, INC BS012E12A38 Uses service part: 3830114S</p> <p>Gasket: 3314250¹²¹⁰, 332418, 3929251 Overall Height: 10.71 (272) Largest OD: 5.08 (129) Thread Size: 1 1/2-16 UN-2B</p>	<p>HF6726</p>  <p>NORMAN EQUIPMENT 64400071 Uses service part: 3830114S</p> <p>Gasket: 3314250¹²¹⁰, 332418, 3929251 Overall Height: 10.71 (272) Largest OD: 5.08 (129) Thread Size: 1 1/2-16 UN-2B</p>	<p>HF6750</p>  <p>FORD 9826688</p> <p>Overall Height: 6.70 (170) Largest OD: 5.08 (129) Thread Size: 1 1/2-16 UN-2B</p>
<p>HF6713</p>  <p>PALL HC7500SUS8H, PUROLATOR H55136, NORMAN EQUIPMENT 612M, BEHRINGER FLUID SYSTEMS, INC BS012E12A38 Uses service part: 3830114S</p> <p>Gasket: 3314250¹²¹⁰, 332418, 3929251 Overall Height: 10.71 (272) Largest OD: 5.08 (129) Thread Size: 1 1/2-16 UN-2B</p>	<p>HF6728</p>  <p>PARKER 929310</p> <p>Gasket: 332418 Overall Height: 6.71 (170) Largest OD: 5.08 (129) Thread Size: 1 1/2-16 UN-2B</p>	<p>HF6753</p>  <p>Various Hydraulic Applications</p> <p>Overall Height: 6.95 (176) Largest OD: 4.71 (120) Thread Size: 1 1/2-16 UN-2B</p>

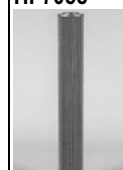









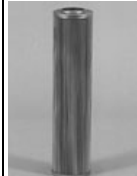
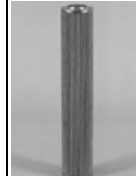

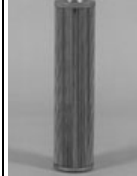

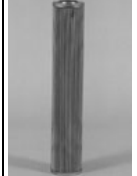

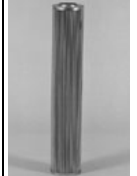
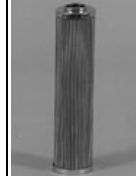
E. PRODUCT GUIDE

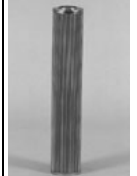
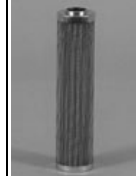
HF6775 	BEHRINGER FLUID SYSTEMS, INC BS0128S03A38200 Gasket: 332418, 3929251 Overall Height: 6.71 (170) Largest OD: 5.08 (129) Thread Size: 1 1/2-16 UN-2B	HF6802 	JOHN DEERE AT103193 Filter used with AT144995, HH6952 Overall Height: 8.22 (209) Largest OD: 5.00 (127) Thread Size: 1 1/2-16 UN-2B	HF6825 	JOHN DEERE AT173244 Overall Height: 8.22 (209) Largest OD: 5.00 (127) Thread Size: 1 1/2-16 UN-2B
HF6776 	BEHRINGER FLUID SYSTEMS, INC BS0128E03A38200 Gasket: 332418, 3929251 Overall Height: 10.71 (272) Largest OD: 5.08 (129) Thread Size: 1 1/2-16 UN-2B	HF6807 	General Usage Overall Height: 11.71 (297) Largest OD: 5.00 (127) Thread Size: 1 1/2-16 UN-2B	HF6828 	JOHN DEERE AT180249 Overall Height: 11.84 (301) Largest OD: 4.82 (122) Thread Size: 1 1/2-16 UN-2B
HF6777 	SCHROEDER SBF75004Z5B Gasket: 332418, 3929251 Overall Height: 6.71 (170) Largest OD: 5.08 (129) Thread Size: 1 1/2-16 UN-2B	HF6808 	JOHN DEERE AT144879, DONALDSON P551244 Filter used with HH6952 Overall Height: 8.22 (209) Largest OD: 5.00 (127) Thread Size: 1 1/2-16 UN-2B	HF6831 	JOHN DEERE AT210148 Filter used with HH6952 Overall Height: 8.22 (209) Largest OD: 5.00 (127) Thread Size: 1 1/2-16 UN-2B
HF6778 	SCHROEDER SBF75008S3B, STAUFF SF6707MG Gasket: 332418, 3929251 Overall Height: 10.71 (272) Largest OD: 5.08 (129) Thread Size: 1 1/2-16 UN-2B	HF6809 	JOHN DEERE AT140315 Filter used with HH6952 Overall Height: 11.71 (297) Largest OD: 5.00 (127) Thread Size: 1 1/2 - 16 UN-2B	HF6833 	JOHN DEERE AT184206 Overall Height: 8.22 (209) Largest OD: 4.90 (124) Thread Size: 1 1/2-16 UN-2B
HF6779 	PALL HC7500SUS4H, SCHROEDER SBF75004Z10B Gasket: 332418, 3929251 Overall Height: 6.71 (170) Largest OD: 5.08 (129) Thread Size: 1 1/2-16 UN-2B	HF6813 	JOHN DEERE AT209204 Overall Height: 11.71 (297) Largest OD: 5.00 (127) Thread Size: 1 1/2-16 UN-2B	HF6834 	AG CHEM EQUIPMENT 610114, JOHN DEERE YZ104780 Overall Height: 11.71 (297) Largest OD: 5.00 (127) Thread Size: 1 1/2-16 UN-2B
HF6780 	SCHROEDER SBF75008Z10B, STAUFF SF6731MG Gasket: 332418, 3929251 Overall Height: 10.71 (272) Largest OD: 5.08 (129) Thread Size: 1 1/2-16 UN-2B	HF6820 	General Usage Overall Height: 11.31 (287) Largest OD: 4.74 (120) Thread Size: 1 1/2-16 UN-2B	HF6836 	KOMATSU 1214275H4 Overall Height: 11.71 (297) Largest OD: 4.95 (126) Thread Size: 1 1/2-16 UN-2B
HF6781 	EUCLID 12597989 Gasket: 332418, 3929251 Overall Height: 6.71 (170) Largest OD: 5.08 (129) Thread Size: 1 1/2-16 UN-2B	HF6822 	General Usage Overall Height: 11.29 (287) Largest OD: 4.74 (120) Thread Size: 1 1/4-11 BSPP-2	HF6839 	JOHN DEERE AT193966 Overall Height: 11.78 (299) Largest OD: 4.90 (124) Thread Size: 1 1/2-16 UN-2B
HF6782 	STAUFF SF6726MG Gasket: 332418, 3929251 Overall Height: 10.71 (272) Largest OD: 5.08 (129) Thread Size: 1 1/2-16 UN-2B	HF6824 	JOHN DEERE AT172912 Filter used with HH6952 Overall Height: 11.73 (298) Largest OD: 4.95 (126) Thread Size: 1 1/2-16 UN-2B	HF6840 	JOHN DEERE AT193883 Overall Height: 8.22 (209) Largest OD: 4.90 (124) Thread Size: 1 1/2-16 UN-2B
				HF7001 	PALL HC8300FUN8H Overall Height: 8.16 (207) Overall OD: 5.98 (152) End 1 ID: 4.11 (104)

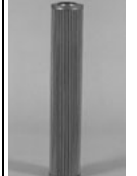
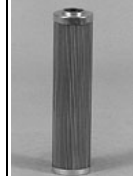

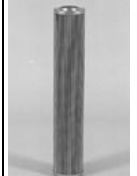

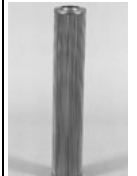





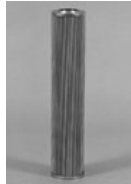
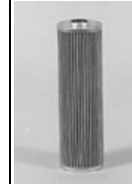
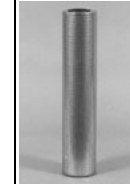
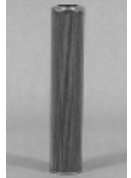
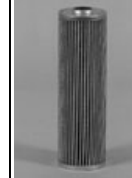
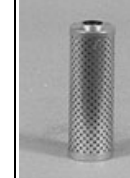

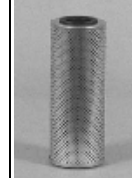

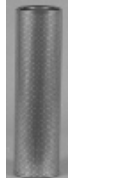

E. PRODUCT GUIDE

HF7008  PALL HC8300FUP39H For Upgrade, use HF30634 Overall Height: 38.66 (982) Overall OD: 5.98 (152) End 1 ID: 4.11 (104)	HF7040  PALL HC9020FUP4H For Upgrade, use HF30383 Gasket: 3913044 (1) Overall Height: 4.47 (114) End 1 OD: 1.78 (45) End 2 OD: 1.75 (44) End 2 ID: 0.98 (25)	HF7052  HYDAC H940013003BN Overall Height: 13.12 (333) Overall OD: 3.79 (96) End 1 ID: 2.18 (55)
HF7010  PALL HC8300FUS39H For Upgrade, use HF30340 Overall Height: 38.66 (982) Overall OD: 5.98 (152) End 1 ID: 4.11 (104)	HF7041  PALL HC9020FUN4H For Upgrade, use HF30028 Gasket: 3913044 (1) Overall Height: 4.47 (114) End 1 OD: 1.78 (45) End 2 OD: 1.75 (44) End 2 ID: 0.98 (25)	HF7053  PALL HC9400FUN13H For Upgrade, use HF30156 Overall Height: 13.12 (333) Overall OD: 3.79 (96) End 1 ID: 2.18 (55)
HF7012  PALL HC8400FUP8H Overall Height: 8.17 (208) Overall OD: 5.99 (152) End 1 ID: 3.23 (82)	HF7042  For Upgrade, use HF30199 Gasket: 3913044 (1) Overall Height: 4.47 (114) End 1 OD: 1.78 (45) End 2 OD: 1.75 (44) End 2 ID: 0.98 (25)	HF7054  PALL HC9400FUS13H For Upgrade, use HF30288 Overall Height: 13.12 (333) Overall OD: 3.79 (96) End 1 ID: 2.18 (55)
HF7021  PALL HC8400FUN26H For Upgrade, use HF30123 Overall Height: 25.62 (651) Overall OD: 5.99 (152) End 1 ID: 3.26 (83)	HF7043  PALL HC9020FUT4H Gasket: 3913044 (1) Overall Height: 4.47 (114) End 1 OD: 1.78 (45) End 2 OD: 1.75 (44) End 2 ID: 0.98 (25)	HF7055  PALL HC9400FUT13H Overall Height: 13.12 (333) Overall OD: 3.79 (96) End 1 ID: 2.18 (55)
HF7024  PALL HC8400FUP39H Overall Height: 38.67 (982) Overall OD: 5.99 (152) End 1 ID: 3.26 (83)	HF7044  PALL HC9020FUP8H For Upgrade, use HF30436 Gasket: 3913044 (1) Overall Height: 8.10 (206) End 1 OD: 1.78 (45) End 2 OD: 1.75 (44) End 2 ID: 0.98 (25)	HF7057  PALL HC9400FUN26H For Upgrade, use HF30131 Overall Height: 25.93 (659) Overall OD: 3.79 (96) End 1 ID: 2.18 (55)
HF7028  PALL HC8500FUP8H For Upgrade, use HF30451 Overall Height: 8.04 (204) Overall OD: 3.78 (96) End 1 ID: 1.69 (43)	HF7045  PALL HC9020FUN8H For Upgrade, use HF30062 Gasket: 3913044 (1) Overall Height: 8.10 (206) End 1 OD: 1.78 (45) End 2 OD: 1.75 (44) End 2 ID: 0.98 (25)	HF7058  PALL HC9400FUS26H Overall Height: 25.93 (659) Overall OD: 3.79 (96) End 1 ID: 2.18 (55)
HF7032  PALL HC8500FUP13H Overall Height: 12.78 (325) Overall OD: 3.78 (96) End 1 ID: 1.67 (42)	HF7046  PALL HC9020FUS8H For Upgrade, use HF30236 Gasket: 3913044 (1) Overall Height: 8.10 (206) End 1 OD: 1.78 (45) End 2 OD: 1.75 (44) End 2 ID: 0.98 (25)	HF7064  PALL HC9600FUP4H For Upgrade, use HF30402 Overall Height: 4.63 (118) End 1 OD: 3.12 (79) End 2 OD: 3.11 (79) End 2 ID: 1.67 (42)
HF7033  PALL HC8500FUN13H For Upgrade, use HF30154 Not available in all parts of the world. Overall Height: 12.78 (325) Overall OD: 3.78 (96) End 1 ID: 1.67 (42)	HF7047  PALL HC9020FUT8H Gasket: 3913044 (1) Overall Height: 8.10 (206) End 1 OD: 1.78 (45) End 2 OD: 1.75 (44) End 2 ID: 0.98 (25)	HF7065  PALL HC9600FUN4H For Upgrade, use HF30036 Overall Height: 4.63 (118) End 1 OD: 3.12 (79) End 2 OD: 3.11 (79) End 2 ID: 1.67 (42)

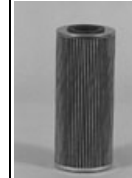
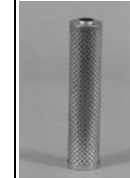

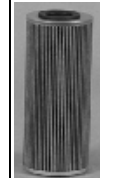



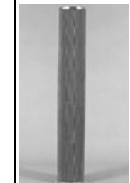







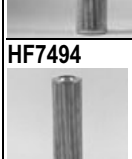



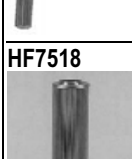

E. PRODUCT GUIDE

<p>HF7066 PALL HC9600FUS4H For Upgrade, use HF30210</p>  <p>Gasket: 3832316 (1) Overall Height: 4.63 (118) End 1 OD: 3.12 (79) End 2 OD: 3.11 (79) End 2 ID: 1.67 (42)</p>	<p>HF7074 PALL HC9600FUS13H</p>  <p>Overall Height: 12.94 (329) End 1 OD: 3.12 (79) End 2 OD: 3.11 (79) End 2 ID: 1.67 (42)</p>	<p>HF7095 PALL HC9650FUT16H</p>  <p>Overall Height: 17.03 (432) Overall OD: 3.11 (79) End 1 ID: 1.67 (42)</p>
<p>HF7067 PALL HC9600FUT4H For Upgrade, use HF30697</p>  <p>Overall Height: 4.63 (118) End 1 OD: 3.12 (79) End 2 OD: 3.11 (79) End 2 ID: 1.67 (42)</p>	<p>HF7075 PALL HC9600FUT13H</p>  <p>Overall Height: 12.94 (329) End 1 OD: 3.12 (79) End 2 OD: 3.11 (79) End 2 ID: 1.67 (42)</p>	<p>HF7103 PALL HC9800FUT4H</p>  <p>Overall Height: 4.43 (113) Overall OD: 1.98 (50) End 1 ID: 0.92 (23)</p>
<p>HF7068 PALL HC9600FUP8H For Upgrade, use HF30453</p>  <p>Overall Height: 8.19 (208) End 1 OD: 3.12 (79) End 2 OD: 3.11 (79) End 2 ID: 1.67 (42)</p>	<p>HF7076 PALL HC9600FUP16H For Upgrade, use HF30584</p>  <p>Overall Height: 16.86 (428) End 1 OD: 3.12 (79) End 2 OD: 3.11 (79) End 2 ID: 1.67 (42)</p>	<p>HF7104 PALL HC9800FUP8H For Upgrade, use HF30442</p>  <p>Overall Height: 8.19 (208) Overall OD: 1.98 (50) End 1 ID: 0.92 (23)</p>
<p>HF7069 PALL HC9600FUN8H For Upgrade, use HF30084</p>  <p>Overall Height: 8.19 (208) End 1 OD: 3.12 (79) End 2 OD: 3.11 (79) End 2 ID: 1.67 (42)</p>	<p>HF7077 PALL HC9600FUN16H</p>  <p>Overall Height: 16.86 (428) End 1 OD: 3.12 (79) End 2 OD: 3.11 (79) End 2 ID: 1.67 (42)</p>	<p>HF7105 PALL HC9800FUN8H For Upgrade, use HF30071</p>  <p>Overall Height: 8.19 (208) End 1 OD: 1.98 (50) End 2 OD: 1.98 (50) End 1 ID: 0.94 (24)</p>
<p>HF7070 PALL HC9600FUS8H For Upgrade, use HF30262</p>  <p>Overall Height: 8.19 (208) End 1 OD: 3.12 (79) End 2 OD: 3.11 (79) End 2 ID: 1.67 (42)</p>	<p>HF7078 PALL HC9600FUS16H</p>  <p>Overall Height: 16.86 (428) End 1 OD: 3.12 (79) End 2 OD: 3.11 (79) End 2 ID: 1.67 (42)</p>	<p>HF7106 PALL HC9800FUS8H For Upgrade, use HF30244</p>  <p>Overall Height: 8.19 (208) Overall OD: 1.98 (50) End 1 ID: 0.92 (23)</p>
<p>HF7071 PALL HC9600FUT8H</p>  <p>Overall Height: 8.19 (208) End 1 OD: 3.12 (79) End 2 OD: 3.11 (79) End 2 ID: 1.67 (42)</p>	<p>HF7079 PALL HC9600FUT16H</p>  <p>Overall Height: 16.86 (428) End 1 OD: 3.12 (79) End 2 OD: 3.11 (79) End 2 ID: 1.67 (42)</p>	<p>HF7107 SWIFT FILTERS, INC. SF9800825UM</p>  <p>Overall Height: 8.19 (208) Overall OD: 1.98 (50) End 1 ID: 0.92 (23)</p>
<p>HF7072 PALL HC9600FUP13H For Upgrade, use HF30524</p>  <p>Overall Height: 12.94 (329) End 1 OD: 3.12 (79) End 2 OD: 3.11 (79) End 2 ID: 1.67 (42)</p>	<p>HF7092 PALL HC9650FUP16H</p>  <p>Overall Height: 17.03 (432) Overall OD: 3.11 (79) End 1 ID: 1.67 (42)</p>	<p>HF7121 PALL HC8800FUP8H For Upgrade, use HF30457</p>  <p>Overall Height: 8.16 (207) Overall OD: 3.39 (86) End 1 ID: 1.93 (49)</p>
<p>HF7073 PALL HC9600FUN13H</p>  <p>Overall Height: 12.94 (329) End 1 OD: 3.12 (79) End 2 OD: 3.11 (79) End 2 ID: 1.67 (42)</p>	<p>HF7093 PALL HC9650FUN16H</p>  <p>Overall Height: 17.03 (432) Overall OD: 3.11 (79) End 1 ID: 1.67 (42)</p>	<p>HF7124 PALL HC8800FUT8H</p>  <p>Overall Height: 8.16 (207) Overall OD: 3.39 (86) End 1 ID: 1.93 (49)</p>

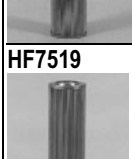

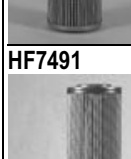
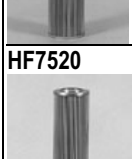





















E. PRODUCT GUIDE

HF7130  PALL HC8800FUN16H For Upgrade, use HF30112 Overall Height: 16.91 (430) Overall OD: 3.39 (86) End 1 ID: 1.93 (49)	HF7317  SCHROEDER CCS3 Upgrade of HF7313 Overall Height: 9.56 (243) Overall OD: 2.88 (73) End 1 ID: 1.07 (27)	HF7338  SCHROEDER KK10 Overall Height: 18.20 (462) Overall OD: 3.90 (99) End 1 ID: 1.81 (46)
HF7131  PALL HC8800FUS16H For Upgrade, use HF30310 Overall Height: 16.91 (430) Overall OD: 3.39 (86) End 1 ID: 1.93 (49)	HF7318  SCHROEDER CCS7 Overall Height: 9.56 (243) Overall OD: 2.88 (73) End 1 ID: 1.07 (27)	HF7347  SCHROEDER N3 Overall Height: 5.25 (133) Overall OD: 1.76 (45) End 1 ID: 0.77 (19)
HF7301  SCHROEDER AS3 Overall Height: 4.88 (124) Overall OD: 2.88 (73) End 1 ID: 1.07 (27)	HF7325  SCHROEDER J3 Overall Height: 9.09 (231) Overall OD: 3.51 (89) End 1 ID: 1.30 (33)	HF7348  SCHROEDER N10 Overall Height: 5.25 (133) Overall OD: 1.76 (45) End 1 ID: 0.77 (19)
HF7302  SCHROEDER AS7 Overall Height: 4.88 (124) Overall OD: 2.88 (73) End 1 ID: 1.07 (27)	HF7326  SCHROEDER J10 Overall Height: 9.09 (231) Overall OD: 3.51 (89) End 1 ID: 1.30 (33)	HF7350  SCHROEDER NS3 Overall Height: 5.25 (133) Overall OD: 1.76 (45) End 1 ID: 0.77 (19)
HF7304  SCHROEDER BB10 Overall Height: 18.18 (462) Overall OD: 5.00 (127) End 1 ID: 3.26 (83)	HF7327  SCHROEDER J25 Overall Height: 9.09 (231) Overall OD: 3.51 (89) End 1 ID: 1.30 (33)	HF7351  SCHROEDER NS7 Overall Height: 5.25 (133) Overall OD: 1.76 (45) End 1 ID: 0.77 (19)
HF7308  SCHROEDER C10 Overall Height: 4.69 (119) Overall OD: 2.88 (73) End 1 ID: 1.07 (27)	HF7331  SCHROEDER KS1 Overall Height: 9.09 (231) Overall OD: 3.90 (99) End 1 ID: 1.81 (46)	HF7353  SCHROEDER NN10 Overall Height: 8.03 (204) Overall OD: 1.76 (45) End 1 ID: 0.77 (19)
HF7313  SCHROEDER CC3 For Upgrade, use HF7317 Overall Height: 9.56 (243) Overall OD: 2.88 (73) End 1 ID: 1.07 (27)	HF7332  SCHROEDER KS3, PARKER 925778 Upgrade of HF6109 Overall Height: 9.23 (234) Overall OD: 3.93 (100) End 1 ID: 1.61 (41)	HF7360  VICKERS V0191B1R10 Not available in all parts of the world. Overall Height: 5.73 (146) Largest OD: 3.72 (94) Thread Size: 1/8-16 UN-2B
HF7314  SCHROEDER CC10 Overall Height: 9.56 (243) Overall OD: 2.88 (73) End 1 ID: 1.07 (27)	HF7336  SCHROEDER KW Overall Height: 9.37 (238) Overall OD: 3.91 (99) End 1 ID: 1.81 (46)	HF7411  PALL HC8300FUT39Z Overall Height: 38.66 (982) Overall OD: 5.98 (152) End 1 ID: 4.11 (104)

E. PRODUCT GUIDE

HF7442  UCC HYDRAULICS UCR122910 Overall Height: 1.28 (33) Overall OD: 1.18 (30) End 1 ID: 0.53 (14)	HF7472  GMC 23018850 Overall Height: 12.94 (329) End 1 OD: 3.12 (79) End 2 OD: 3.11 (79) End 2 ID: 1.67 (42)	HF7493  PALL HC9650FUN16Z Overall Height: 17.03 (432) Overall OD: 3.11 (79) End 1 ID: 1.67 (42)
HF7444  UCC HYDRAULICS UCSE1457 Overall Height: 5.51 (140) End 1 OD: 2.52 (64) End 2 OD: 2.34 (60) Thread Size: 1 BSP	HF7473  PALL HC9600FUN13Z Overall Height: 12.94 (329) End 1 OD: 3.10 (79) End 2 OD: 3.11 (79) End 2 ID: 1.67 (42)	HF7494  PALL HC9650FUS16Z Overall Height: 17.03 (432) Overall OD: 3.11 (79) End 1 ID: 1.67 (42)
HF7464  PALL HC9600FUP4Z Overall Height: 4.63 (118) End 1 OD: 3.12 (79) End 2 OD: 3.11 (79) End 2 ID: 1.67 (42)	HF7474  GMC 23018851 Overall Height: 12.94 (329) End 1 OD: 3.12 (79) End 2 OD: 3.11 (79) End 2 ID: 1.67 (42)	HF7495  PALL HC9650FUT16Z Overall Height: 17.03 (432) Overall OD: 3.11 (79) End 1 ID: 1.67 (42)
HF7466  PALL HC9600FUS4Z Overall Height: 4.63 (118) End 1 OD: 3.12 (79) End 2 OD: 3.11 (79) End 2 ID: 1.67 (42)	HF7475  PALL HC9600FUT13Z Overall Height: 12.94 (329) End 1 OD: 3.12 (79) End 2 OD: 3.11 (79) End 2 ID: 1.67 (42)	HF7503  SCHROEDER UU25 Overall Height: 9.76 (248) Overall OD: 1.00 (25) End 1 ID: 0.47 (12)
HF7467  PALL HC9600FUT4Z Overall Height: 4.63 (118) End 1 OD: 3.12 (79) End 2 OD: 3.11 (79) End 2 ID: 1.67 (42)	HF7479  PALL HC9600FUT16Z, INGERSOLL-RAND 57394728 Overall Height: 16.86 (428) End 1 OD: 3.12 (79) End 2 OD: 3.11 (79) End 2 ID: 1.67 (42)	HF7518  PALL HC8900FUP16H Overall Height: 16.87 (429) Overall OD: 3.79 (96) End 1 ID: 2.18 (55)
HF7468  PALL HC9600FUP8Z For Upgrade, use HF30454 Overall Height: 8.19 (208) End 1 OD: 3.12 (79) End 2 OD: 3.11 (79) End 2 ID: 1.67 (42)	HF7488  PALL HC9650FUP8Z Overall Height: 8.36 (212) End 1 OD: 3.11 (79) End 2 OD: 3.02 (77) End 1 ID: 1.67 (42)	HF7519  PALL HC8900FUS16H Gasket: 3832397 Overall Height: 16.87 (429) Overall OD: 3.79 (96) End 1 ID: 2.18 (55)
HF7470  PALL HC9600FUS8Z Overall Height: 8.19 (208) End 1 OD: 3.12 (79) End 2 OD: 3.11 (79) End 2 ID: 1.67 (42)	HF7491  PALL HC9650FUT8Z Overall Height: 8.36 (212) Overall OD: 3.11 (79) End 1 ID: 1.67 (42)	HF7520  PALL HC8900FUN16Z For Upgrade, use HF30114 Gasket: 3832397 (1) Overall Height: 16.87 (429) Overall OD: 3.79 (96) End 1 ID: 2.18 (55)
HF7471  PALL HC9600FUT8Z Overall Height: 8.19 (208) End 1 OD: 3.12 (79) End 2 OD: 3.11 (79) End 2 ID: 1.67 (42)	HF7492  PALL HC9650FUP16Z For Upgrade, use HF30583 Overall Height: 17.03 (432) Overall OD: 3.11 (79) End 1 ID: 1.67 (42)	HF7524  PALL HC8800FDT8Z Overall Height: 8.16 (207) Overall OD: 3.39 (86) End 1 ID: 1.93 (49)

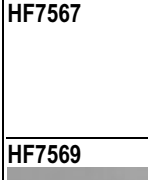









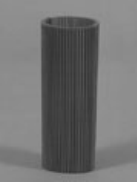

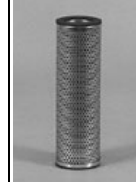
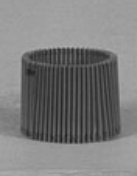



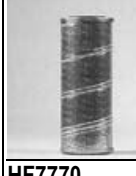
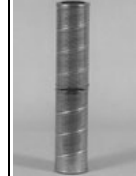
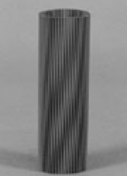

E. PRODUCT GUIDE

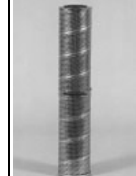
HF7527  PALL HC8800FUS13Z For Upgrade, use HF30281 Overall Height: 12.98 (330) Overall OD: 3.39 (86) End 1 ID: 1.93 (49)	HF7551  KUBOTA 3270137950 Overall Height: 5.56 (141) Largest OD: 3.82 (97) Thread Size: 1 1/8-16 UN-2B	HF7607  SCANIA 274108 Overall Height: 3.39 (86) Overall OD: 4.65 (118) End 1 ID: 2.32 (59)
HF7530  PALL HC8800FUN16Z Not available in all parts of the world. Overall Height: 16.91 (430) Overall OD: 3.39 (86) End 1 ID: 1.93 (49)	HF7552  SCANIA 684864 Overall Height: 5.51 (140) Overall OD: 2.76 (70) BPV Setting: 33.36 (230) End 1 ID: 1.14 (29)	HF7608  CASE 829528C1 Upgrade of HF6056 Overall Height: 5.83 (148) Largest OD: 3.69 (94) Thread Size: 1-12 UNF-2B
HF7535  SCANIA 1301696 Overall Height: 4.45 (113) Largest OD: 3.86 (98) ADBV: Yes BPV Setting: 29.01 (200) Thread Size: M23 X 1.5-6H INT	HF7553  HITACHI 4252563 Overall Height: 5.95 (151) Largest OD: 3.82 (97) Thread Size: 1 1/8-16 UN-2B	HF7609  CASE 1282528C1 Overall Height: 6.94 (176) Largest OD: 3.68 (93) Thread Size: 1 1/8-16 UN-2B
HF7536  NEW HOLLAND 86000485 Overall Height: 3.79 (96) Largest OD: 3.72 (94) Thread Size: 1 1/8-16 UN-2B	HF7554  SCANIA 387284 Overall Height: 4.61 (117) Largest OD: 3.05 (78) BPV Setting: 14.50 (100) Thread Size: M16 X 1.5-6H INT	HF7615  RENAULT V.I. 5000791145 Overall Height: 2.91 (74) Largest OD: 3.48 (89) ADBV: Yes BPV Setting: 14.50 (100) Thread Size: M20 X 1.5-6H INT
HF7538  KOEHRING 7086449 Overall Height: 15.12 (384) Overall OD: 6.50 (165) End 1 ID: 3.46 (88)	HF7556  ZINGA ZAE10L Overall Height: 8.14 (207) Largest OD: 3.72 (94) Thread Size: 1-12 UNF-2B	HF7622  VICKERS V0191B1R05 Not available in all parts of the world. Overall Height: 5.73 (146) Largest OD: 3.72 (94) Thread Size: 1 1/8-16 UN-2B
HF7541  MASSEY-FERGUSON 3581032M2 May not be available in all regions of the world Overall Height: 7.13 (181) Largest OD: 5.39 (137) Thread Size: M42 X 2-6H INT	HF7560  ORENSTEIN & KOPPEL 1771469 Overall Height: 14.17 (360) End 1 OD: 5.91 (150) End 2 OD: 5.39 (137) End 1 ID: 3.15 (80)	HF7657  UCC HYDRAULICS UC2108 Overall Height: 5.55 (141) Overall OD: 2.17 (55) End 1 ID: 0.93 (24)
HF7543  RENAULT V.I. 870229300, LAUTRETTE L1477 Overall Height: 2.22 (57) Overall OD: 3.33 (85) End 1 ID: 0.52 (13)	HF7561  LEYLAND ABU6540 Overall Height: 3.47 (88) Overall OD: 2.82 (72) End 1 ID: 1.30 (33)	HF7658  UCC HYDRAULICS UCR63013 Not available in all parts of the world.
HF7550  DANA-SPICER 504807, AVELING-BARFORD ABP3003018 Overall Height: 3.64 (93) Largest OD: 3.68 (94) ADBV: Yes BPV Setting: 17.40 (120) Thread Size: 13/16-16 UN-2B	HF7567  DONALDSON P174233 Overall Height: 8.78 (223) Largest OD: 3.73 (95) BPV Setting: 17.69 (122) Thread Size: 1 1/4-12 UNF-2B	HF7701  PARKER G02058 Overall Height: 4.65 (118) Overall OD: 1.75 (44) End 1 ID: 1.00 (25)
	HF7569  FIAT-ALLIS 1909130, TECNOCAR R413, MANN & HUMMEL W11502 Overall Height: 7.34 (187) Largest OD: 4.33 (110) Thread Size: 1 1/8-16 UN-2B	







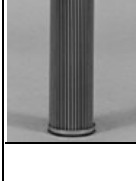
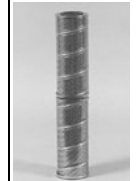





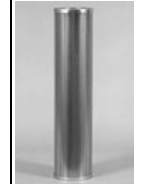

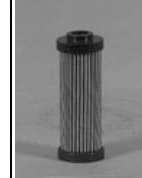



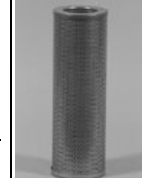

E. PRODUCT GUIDE

HF7702  PARKER G02064 Overall Height: 8.35 (212) Overall OD: 1.75 (44) End 1 ID: 1.00 (25)	HF7722  PARKER 907088 Overall Height: 15.13 (384) Overall OD: 3.59 (91) End 1 ID: 1.90 (48)	HF7732  PARKER 909299 Overall Height: 9.51 (242) Overall OD: 4.25 (108) End 1 ID: 3.12 (79)
HF7703  PARKER G02070 Overall Height: 5.27 (134) Overall OD: 2.44 (62) End 1 ID: 1.20 (30) End 2 ID: 1.15 (29)	HF7723  PARKER 907090 Overall Height: 15.13 (384) Overall OD: 3.59 (91) End 1 ID: 1.90 (48)	HF7736  PARKER 922622 Overall Height: 4.95 (126) Overall OD: 2.44 (62) End 1 ID: 1.46 (37)
HF7705  PARKER G02082 Overall Height: 8.13 (207) Overall OD: 3.68 (93) End 1 ID: 2.05 (52) End 2 ID: 1.88 (48)	HF7724  PARKER 907233 Overall Height: 7.76 (197) Overall OD: 3.59 (91) End 1 ID: 1.90 (48)	HF7738  PARKER 922624 Overall Height: 5.38 (137) Overall OD: 2.44 (62) End 1 ID: 1.02 (26)
HF7706  PARKER G02088 Overall Height: 12.70 (323) Overall OD: 3.68 (93) End 1 ID: 2.05 (52) End 2 ID: 1.88 (48)	HF7725  PARKER 907234 Overall Height: 7.76 (197) Overall OD: 3.59 (91) End 1 ID: 1.90 (48)	HF7739  PARKER 922625 Overall Height: 4.95 (126) Overall OD: 2.44 (62) End 1 ID: 1.46 (37)
HF7710  PARKER 901493 Overall Height: 2.89 (73) Overall OD: 2.73 (69) End 1 ID: 1.68 (43)	HF7726  PARKER 908642 Overall Height: 9.51 (242) Overall OD: 4.25 (108) End 1 ID: 3.12 (79)	HF7740  PARKER 922627 Overall Height: 4.95 (126) Overall OD: 2.44 (62) End 1 ID: 1.46 (37)
HF7714  PARKER 901619 Overall Height: 9.08 (231) Overall OD: 5.75 (146)	HF7727  PARKER 908643 Overall Height: 9.51 (242) Overall OD: 4.25 (108) End 1 ID: 3.12 (79)	HF7743  PARKER 922785 Overall Height: 9.56 (243) Overall OD: 4.25 (108) End 1 ID: 3.12 (79)
HF7720  PARKER 906460 Overall Height: 13.88 (352) Overall OD: 3.94 (100) End 1 ID: 3.00 (76)	HF7728  PARKER 908648 Overall Height: 12.00 (305) Overall OD: 5.64 (143) End 1 ID: 4.00 (102)	HF7744  PARKER 922787 Overall Height: 12.00 (305) Overall OD: 5.64 (143) End 1 ID: 4.00 (102)
HF7721  PARKER 906461 Overall Height: 13.70 (348) Overall OD: 3.95 (100) End 1 ID: 3.03 (77)	HF7730  PARKER 909293 Overall Height: 9.51 (242) Overall OD: 4.25 (108) End 1 ID: 3.12 (79)	HF7747  PARKER 922932 Overall Height: 2.29 (58) Overall OD: 2.73 (69) End 1 ID: 2.27 (58)







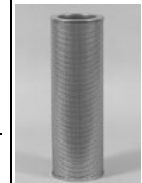









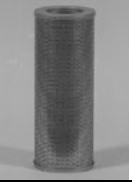



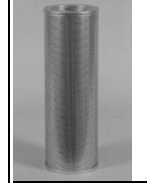

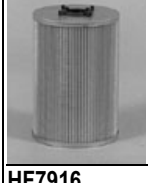
E. PRODUCT GUIDE

HF7751 PARKER 922972  Overall Height: 6.54 (166) Overall OD: 2.73 (69) End 1 ID: 2.65 (67)	HF7767 PARKER 924450  Overall Height: 9.12 (232) Overall OD: 3.68 (93) End 1 ID: 1.75 (44)	HF7778 PARKER 924739 
HF7755 PARKER 922993  Overall Height: 3.54 (90) Overall OD: 2.73 (69) End 1 ID: 2.30 (58)	HF7768 PARKER 924451  Overall Height: 9.05 (230) Overall OD: 3.72 (94) End 1 ID: 1.95 (50)	HF7779 PARKER 924790  Overall Height: 18.55 (471) Overall OD: 3.68 (93) End 1 ID: 1.78 (45)
HF7757 PARKER 923008  Overall Height: 8.67 (220) Overall OD: 2.75 (70) End 1 ID: 2.25 (57)	HF7769 PARKER 924453  Overall Height: 9.05 (230) Overall OD: 3.72 (94) End 1 ID: 1.95 (50)	HF7781 PARKER 924792  Overall Height: 18.43 (468) Overall OD: 3.68 (93) End 1 ID: 1.75 (44)
HF7758 PARKER 923009  Overall Height: 8.67 (220) Overall OD: 2.75 (70) End 1 ID: 2.25 (57)	HF7770 PARKER 924455  Overall Height: 9.06 (230) Overall OD: 3.68 (93) End 1 ID: 1.78 (45)	HF7783 PARKER 924794  Overall Height: 18.81 (478) Overall OD: 3.72 (94) End 1 ID: 1.95 (50)
HF7763 PARKER 923047  Overall Height: 13.83 (351) Overall OD: 3.81 (97) End 1 ID: 3.01 (76)	HF7773 PARKER 924730  Overall Height: 8.68 (220) Overall OD: 2.74 (70) End 1 ID: 1.69 (43)	HF7784 PARKER 924795  Overall Height: 18.81 (478) Overall OD: 3.72 (94) End 1 ID: 1.95 (50)
HF7764 PARKER 924423  Overall Height: 4.95 (126) Overall OD: 2.44 (62) End 1 ID: 1.46 (37)	HF7774 PARKER 924732  Overall Height: 8.68 (220) Overall OD: 2.74 (70) End 1 ID: 1.69 (43)	HF7786 PARKER 924798  Overall Height: 18.55 (471) Overall OD: 3.68 (93) End 1 ID: 1.72 (44)
HF7765 PARKER 924448  Overall Height: 9.12 (232) Overall OD: 3.68 (93) End 1 ID: 1.75 (44)	HF7775 PARKER 924734  Overall Height: 8.68 (220) Overall OD: 2.74 (70) End 1 ID: 1.69 (43)	HF7789 PARKER 925040  Overall Height: 9.05 (230) Overall OD: 3.72 (94) End 1 ID: 1.95 (50)
HF7766 PARKER 924449  Overall Height: 9.05 (230) Overall OD: 3.72 (94) End 1 ID: 1.95 (50)	HF7777 PARKER 924738 May not be available in all regions of the world  Overall Height: 8.68 (220) Overall OD: 2.74 (70) End 1 ID: 1.69 (43)	HF7790 PARKER 925052  Overall Height: 18.55 (471) Overall OD: 3.68 (93) End 1 ID: 1.72 (44)



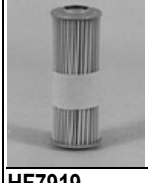









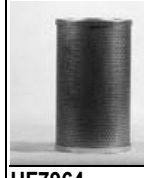











E. PRODUCT GUIDE

HF7791  PARKER 925572 Overall Height: 4.47 (114) Overall OD: 1.75 (44) End 1 ID: 1.00 (25)	HF7809  PARKER 983061 Overall Height: 7.79 (198) Overall OD: 3.60 (91) End 1 ID: 1.75 (44)	HF7833  ORENSTEIN & KOPPEL 1717467 Overall Height: 25.51 (648) Overall OD: 5.98 (152) End 1 ID: 3.94 (100)
HF7792  PARKER 925576 Overall Height: 4.47 (114) Overall OD: 1.75 (44) End 1 ID: 1.00 (25)	HF7810  PARKER 987141 Overall Height: 12.00 (305) Overall OD: 5.64 (143) End 1 ID: 4.00 (102)	HF7834  LIEBHERR 7362910 Overall Height: 3.74 (95) Overall OD: 1.38 (35) End 1 ID: 0.44 (11)
HF7793  PARKER 925578 Overall Height: 4.47 (114) Overall OD: 1.75 (44) End 1 ID: 1.00 (25)	HF7811  PARKER G01068 Overall Height: 7.79 (198) Overall OD: 3.67 (93) End 1 ID: 1.88 (48)	HF7835  MP FILTRI CS100P25 Filter used with ST1028HH Overall Height: 7.09 (180) Largest OD: 5.04 (128) Thread Size: 1 1/4 BSP
HF7795  PARKER 925835 Overall Height: 9.63 (245) Overall OD: 2.44 (62) End 1 ID: 1.02 (26)	HF7812  PARKER G01281 Overall Height: 5.41 (137) Overall OD: 2.38 (60) End 1 ID: 1.00 (25)	HF7836  KAWASAKI 4906070030 Overall Height: 9.42 (239) Overall OD: 3.98 (101) End 1 ID: 1.68 (43)
HF7796  PARKER 925839 Overall Height: 9.25 (235) Overall OD: 2.44 (62) End 1 ID: 1.46 (37)	HF7821  Various Applications Overall Height: 6.38 (162) Overall OD: 3.59 (91) End 1 ID: 1.89 (48)	HF7837  KAWASAKI 3098120080 Overall Height: 11.84 (301) Overall OD: 3.99 (101) End 1 ID: 2.53 (64)
HF7797  PARKER 926326 Overall Height: 9.06 (230) Overall OD: 4.43 (113) End 1 ID: 1.67 (42)	HF7826  CAMECO INDUSTRIES 61308228 Overall Height: 10.71 (272) Largest OD: 5.08 (129) Thread Size: 1 1/2-16 UN-2B	HF7838  KAWASAKI 4906070010 Overall Height: 8.93 (227) Overall OD: 4.33 (110) End 1 ID: 1.77 (45)
HF7804  PARKER 927269 Overall Height: 1.86 (47) Overall OD: 1.67 (42) End 1 ID: 0.69 (17)	HF7830  P & H HARNISCHFEGER 1046Z942 Not available in all parts of the world. Overall Height: 12.86 (327) Overall OD: 4.00 (102) End 1 ID: 2.36 (60)	HF7839  KAWASAKI 4906020010 Overall Height: 8.93 (227) Overall OD: 4.33 (110) End 1 ID: 1.77 (45)
HF7805  PARKER 927584 Overall Height: 9.06 (230) Overall OD: 3.68 (93) End 1 ID: 1.78 (45)	HF7831  VOITH 90537311 Overall Height: 7.95 (202) Overall OD: 3.28 (83) BPV Setting: 29.01 (200) End 1 ID: 1.15 (29)	HF7840  KAWASAKI 3098120060 Overall Height: 17.72 (450) Overall OD: 5.91 (150) End 1 ID: 4.33 (110)



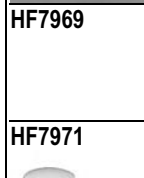



















E. PRODUCT GUIDE

HF7841  KAWASAKI 4906070020 Overall Height: 14.92 (379) Overall OD: 4.48 (114) End 1 ID: 2.88 (73)	HF7907  FBO CR2203 The height includes a spring of 113mm Gasket: 3326040 Overall Height: 10.00 (254) Height: 9.84 (250) Overall OD: 5.51 (140) BPV Setting: 34.81 (240) End 1 OD: 5.51 (140) End 1 ID: 2.60 (66)	HF7920  HITACHI 315041
HF7842  KAWASAKI 4033820020 Overall Height: 11.81 (300) Overall OD: 5.91 (150) End 1 ID: 4.33 (110)	HF7908  FBO CR3303 The height includes a spring of 113mm Gasket: 3326040 Overall Height: 12.36 (314) Overall OD: 5.51 (140) BPV Setting: 37.71 (260) End 1 OD: 5.51 (140) End 1 ID: 2.60 (66)	HF7921  HITACHI 4159319, HITACHI 4508505 Overall Height: 17.99 (457) Overall OD: 4.41 (112) End 1 ID: 2.60 (66)
HF7847  KAWASAKI 3098160030 Overall Height: 11.51 (292) Overall OD: 4.45 (113) End 1 ID: 2.76 (70)	HF7909  FBO CR5003 The height includes a spring of 113mm Gasket: 3326040 Overall Height: 12.36 (314) Overall OD: 5.51 (140) BPV Setting: 39.16 (270) End 1 OD: 5.51 (140) End 1 ID: 2.60 (66)	HF7922  HITACHI 3501404
HF7901  UCC HYDRAULICS UC2408 Overall Height: 5.61 (143) Largest OD: 3.68 (94) BPV Setting: 17.40 (120) Thread Size: 3/4-14 BSP	HF7910  FBO CR2503 The height includes a spring of 113mm Gasket: 3326041 Overall Height: 10.00 (254) Overall OD: 5.51 (140) BPV Setting: 36.26 (250) End 1 ID: 2.01 (51)	HF7923  HITACHI 4219713 Overall Height: 17.75 (451) Overall OD: 5.91 (150) End 1 ID: 4.33 (110)
HF7902  FINN FC1050N010BS16 Overall Height: 9.09 (231) Largest OD: 5.20 (132) BPV Setting: 14.50 (100) Thread Size: 1 1/4 BSP	HF7911  FBO CR3253 The height includes a spring of 113mm Gasket: 3326044 Overall Height: 7.87 (200) Overall OD: 5.51 (140) BPV Setting: 29.01 (200) End 1 ID: 2.00 (51)	HF7927  TOYOTA 675022054071 Overall Height: 7.93 (201) Overall OD: 4.25 (108) End 1 ID: 1.05 (27)
HF7904  FBO CR1003 The height includes a spring of 65mm Gasket: 3326042 Overall Height: 7.72 (196) Overall OD: 2.76 (70) BPV Setting: 36.26 (250) End 1 OD: 2.76 (70) End 1 ID: 1.18 (30)	HF7916  LEYLAND RLK2709 Overall Height: 8.29 (211) Largest OD: 3.68 (94) BPV Setting: 36.26 (250) Thread Size: 1-12 UNF-2B	HF7929  YALE & TOWNE 910544400 Overall Height: 7.30 (185) Overall OD: 3.47 (88) End 1 ID: 1.00 (25) Thread Size: 3/4 NPTF
HF7905  FBO CR1253 The height includes a spring of 81mm Gasket: 3326043 Overall Height: 6.69 (170) Overall OD: 3.74 (95) BPV Setting: 23.21 (160) End 1 ID: 161.00 (4089)	HF7918  HITACHI 3021593 Overall Height: 7.95 (202) Overall OD: 2.88 (73) End 1 ID: 1.33 (34) End 2 ID: 1.33 (34)	HF7930  YALE & TOWNE 910545401 Overall Height: 3.87 (98) End 1 OD: 2.50 (64) End 2 OD: 2.40 (61) End 1 ID: 0.94 (24)
HF7906  FBO CR1803 The height includes a spring of 81mm Gasket: 3326043 Overall Height: 11.50 (292) Overall OD: 3.74 (95) BPV Setting: 34.81 (240) End 1 OD: 3.74 (95) End 1 ID: 1.61 (41)	HF7919  VOLVO 62135819 Overall Height: 2.70 (69) Overall OD: 2.17 (55) End 1 ID: 1.04 (27)	HF7935  HITACHI 4205684 Overall Height: 6.89 (175) Largest OD: 5.28 (134) Thread Size: M48 x P2.0

E. PRODUCT GUIDE

HF7936  TOWMOTOR 917336 Overall Height: 7.18 (182) Largest OD: 3.69 (94) Thread Size: 1 1/8-16 UNS-2B	HF7954  HITACHI 4207841 Overall Height: 5.90 (150) Overall OD: 2.06 (52) End 1 OD: 2.01 (51) End 1 ID: 0.83 (21)	HF7962  FAIREY ARLON TXW6ACC10 Synthetic Media Version of HF6181 Overall Height: 8.27 (210) Overall OD: 4.96 (126) End 1 ID: 0.35 (9) End 2 ID: 3.62 (92)
HF7946  VOITH 9043311 Overall Height: 7.00 (178) Largest OD: 5.50 (140) BPV Setting: 22.02 (152) Thread Size: 1 1/2-16 UN-2B	HF7955  KOBELCO 2446U141S2 Overall Height: 5.24 (133) Largest OD: 3.82 (97) Thread Size: 1 1/8-16 UNF-2B	HF7964  FAIREY ARLON TXW8CCC10 Synthetic Media Version of HF6311 Overall Height: 18.90 (480) Overall OD: 4.96 (126) End 1 ID: 0.35 (9) End 2 ID: 3.62 (92)
HF7947  HYDAC MF1601 Overall Height: 7.02 (178) Largest OD: 4.70 (119) Thread Size: 1 1/4-11 BSP-2B	HF7956  KOBELCO R36P0019 Overall Height: 3.44 (87) Overall OD: 1.67 (42) End 1 ID: 0.90 (23)	HF7965  FAIREY ARLON TXW11CC10 Synthetic Media Version of HF6312 Overall Height: 17.32 (440) Overall OD: 7.99 (203) End 1 ID: 0.51 (13) End 2 ID: 6.18 (157)
HF7949  PARKER E01034, DONALDSON P551246 Gasket: 3836569, 3845054 Overall Height: 9.59 (244) Largest OD: 5.39 (137) Thread Size: M42 X 2-6H INT	HF7957  FAIREY ARLON TXW10CC10 Synthetic Media Version of HF6272 Overall Height: 12.99 (330) Overall OD: 7.99 (203) End 1 ID: 0.51 (13) End 2 ID: 6.18 (157)	HF7966  FAIREY ARLON TXW12CC10 Synthetic Media Version of HF6313 Overall Height: 21.46 (545) Overall OD: 7.99 (203) End 1 ID: 0.51 (13) End 2 ID: 6.18 (157)
HF7950  PARKER E01034 Gasket: 3836569, 3845105 Overall Height: 9.59 (244) Largest OD: 5.39 (137) BPV Setting: 4.06 (28) Thread Size: M42 X 2-6H INT	HF7958  FAIREY ARLON TXW8BCC10 Synthetic Media Version of HF6310 Overall Height: 15.35 (390) Overall OD: 4.96 (126) End 1 ID: 0.35 (9) End 2 ID: 3.62 (92)	HF7967  FAIREY ARLON TXW13CC10 Synthetic Media Version of HF6314 Overall Height: 32.48 (825) Overall OD: 7.99 (203) End 1 ID: 0.51 (13) End 2 ID: 6.18 (157)
HF7951  PARKER EO0971 Gasket: 3836569, 3845054 Overall Height: 6.54 (166) Largest OD: 5.39 (137) Thread Size: M42 X 2-6H INT	HF7959  FAIREY ARLON TXW4CC10 Synthetic Media Version of HF6308 Overall Height: 7.48 (190) Overall OD: 4.17 (106) End 1 ID: 0.35 (9) End 2 ID: 2.84 (72)	HF7968  MANN & HUMMEL WD950 Overall Height: 6.87 (175) Largest OD: 3.68 (94) BPV Setting: 36.26 (250) Thread Size: 1-12 UNF-2B
HF7952  PARKER EO1035 Gasket: 3836569, 3845054 Overall Height: 3.96 (100) Largest OD: 5.39 (137) Thread Size: M42 X 2-6H INT	HF7960  FAIREY ARLON TXW5CC10 Synthetic Media Overall Height: 10.24 (260) Overall OD: 4.17 (106) End 1 ID: 0.35 (9) End 2 ID: 2.84 (72)	HF7969  MP PRODUCTS CS100P05A Overall Height: 7.02 Largest OD: 4.66 Thread Size: 1 1/4-11 BSP
HF7953  HITACHI 4206705 Overall Height: 17.75 (451) Overall OD: 5.91 (150) End 1 ID: 4.33 (110)	HF7961  FAIREY ARLON TXW5ACC10 Upgrade of HF6309 Synthetic Media Version of HF6309 Overall Height: 18.31 (465) Overall OD: 4.17 (106) End 1 ID: 0.35 (9) End 2 ID: 2.84 (72)	HF7971  ST ST5811 Overall Height: 11.29 (287) Largest OD: 4.70 (119) Thread Size: 1 1/4-11 BSP-2B
		HF7973  MP FILTRI CS150P25A, MP PRODUCTS CS150P25A Overall Height: 11.29 (287) Largest OD: 4.70 (119) Thread Size: 1 1/4-11 BSP-2B

E. PRODUCT GUIDE

HF7974	DOMANGE FD34A06	HF7989	JOHN DEERE AT162766	HF8024	
HF7977	DOMANGE FD35A10, MP FILTRI CS150A10A		Overall Height: 17.88 (454) Overall OD: 5.91 (150) End 1 ID: 4.33 (110)		Overall Height: 9.23 (234) Overall OD: 3.91 (99) End 1 ID: 1.61 (41)
HF7980	UCC HYDRAULICS MXR9550 Filter used with 3904380 Upgrade of HF6177 Microglass version	HF7990	KUBOTA 6813162130, HITACHI 4294128	HF8081	HYDAC 110D025W
	Overall Height: 7.09 (180) Largest OD: 5.04 (128) Thread Size: 1 1/4 BSP		Overall Height: 5.95 (151) Largest OD: 3.82 (97) Thread Size: 1 1/8-16 UN-2B		Overall Height: 6.02 (153) Overall OD: 1.86 (47) End 1 ID: 0.87 (22)
HF7981	NOREMAT 121706, MANITOU 21967, SOFRALUB 50715	HF7991	FAIREY ARLON TXW8CCC25	HF8084	MASSEY-FERGUSON 3386701M1
	Overall Height: 10.04 (255) Overall OD: 2.76 (70) BPV Setting: 36.26 (250) End 1 ID: 1.61 (41)		Overall Height: 18.90 (480) Overall OD: 4.96 (126) End 1 ID: 0.35 (9) End 2 ID: 3.62 (92)		Overall Height: 10.20 (259) Largest OD: 5.39 (137) BPV Setting: 4.06 (28) Thread Size: M42 X 2-6H INT
HF7983	UCC HYDRAULICS MXR8550 Upgrade of HF6173 Synthetic Media Version	HF7992	J.C.B. 58106301	HF8123	SCHROEDER KM150
	Overall Height: 5.84 (148) Largest OD: 3.86 (98) Thread Size: 3/4 BSP		Overall Height: 11.81 (300) Overall OD: 2.84 (72) End 1 ID: 0.28 (7) End 2 ID: 1.75 (45)		Overall Height: 9.22 (234) Overall OD: 3.91 (99) End 1 ID: 1.61 (41)
HF7984	MANITOU 23091, SOFRALUB 50709	HF7996	GRESEN K23018	HF8140	MOHAWK MFG. 5322412002
	Overall Height: 6.10 (155) Overall OD: 2.76 (70) BPV Setting: 36.26 (250) End 1 ID: 1.61 (41)		Gasket: 3314250 ¹⁰ , 3929251 Overall Height: 6.71 (170) Largest OD: 5.08 (129) Thread Size: 1 1/2-16 UN-2B		Overall Height: 5.06 (129) Overall OD: 3.99 (101) End 1 ID: 1.31 (33) End 2 ID: 1.10 (28)
HF7985	HYDRECO 918X2K, HYDRECO PG918X2K	HF7997	CASE K920522	HF8144	Case 265;1120;1130; 1140 Tractors
	Overall Height: 10.59 (269) Overall OD: 4.03 (102) End 1 ID: 1.56 (40) Thread Size: 1 7/8-12 UN-2A		Overall Height: 3.50 (89) Overall OD: 6.04 (153) End 1 ID: 1.65 (42) End 2 ID: 2.11 (54)		Overall Height: 5.67 (144) Largest OD: 3.69 (94) Thread Size: 1 1/8-16 UN-2B
HF7987	CASE 93413C1	HF7999	ZF 750131003, VOLVO 11932811, RENAULT 5000807213 Uses service part: 3960502S	HF8179	Various applications
	Overall Height: 3.00 (76) Overall OD: 5.10 (130) End 1 ID: 2.75 (70)		Gasket: 3328501, 3328502 Overall Height: 4.09 (104) Overall OD: 2.70 (69) End 1 ID: 1.30 (33)	Overall Height: 11.43 (290) Overall OD: 2.58 (66) End 1 ID: 1.42 (36)	
HF7988	WABCO VS7413, DONALDSON P163448	HF8023	SCHROEDER KM60	HF28202	ST ST6641489BC
	Overall Height: 9.00 (229) Overall OD: 5.07 (129) End 1 ID: 3.34 (85)		Overall Height: 9.23 (234) Overall OD: 3.91 (99) End 1 ID: 1.61 (41)		Overall Height: 9.73 (247) Largest OD: 3.80 (97) Thread Size: 1 1/2-16 UN-2B

E. PRODUCT GUIDE

HF28658 PARKER PR3309



Overall Height: 7.60 (193)
Overall OD: 3.72 (94)
End 1 ID: 1.91 (49)

HF28660 PARKER PR3324



Overall Height: 12.97 (330)
Overall OD: 4.49 (114)
End 1 ID: 2.69 (68)

HF28662 HYDAC 950R025W

Overall Height: 14.27 (362)
Overall OD: 4.90 (124)
End 1 ID: 3.78 (96)

HF28667 PARKER PR3327



Overall Height: 12.99 (330)
Overall OD: 4.49 (114)
End 1 ID: 2.69 (68)

HF28683 Various Applications

Largest OD: 3.20 (81)

HF28690 UCC HYDRAULICS
UCSE1319



Overall Height: 4.06 (103)
Overall OD: 1.73 (44)
Thread Size: 1/2 BSP

HF28691 ST STH708215



Overall Height: 4.33 (110)
Overall OD: 1.98 (50)
End 1 ID: 0.92 (23)

HF28721 HYDAC 950R010BNHC

Overall Height: 14.30 (363)
Overall OD: 5.63 (143)
End 1 ID: 3.78 (96)

HF28731 ZINGA ZAE25LP, JOHN
DEERE AT182209, JOHN
DEERE AT193114,
TIMBERJACK AT193114 Filter
used with HH33000



Overall Height: 8.14 (207)
Largest OD: 3.72 (94)
Thread Size: 1-12 UNF-2B

HF28751 VICKERS V0191B1R03



Overall Height: 5.75 (146)
Largest OD: 3.72 (94)
Thread Size: 1 1/8-16 UN-2B

HF28752 PALL HC7500SKZ8H



Gasket: 3929251
Overall Height: 10.71 (272)
Largest OD: 5.08 (129)
Thread Size: 1 1/2-16 UN-2B

HF28755 MP FILTRI F008



HF28761 PARKER 932630Q



Overall Height: 9.25 (235)
Overall OD: 2.44 (62)
End 1 ID: 1.46 (37)

HF28762 PARKER 924464

Overall Height: 9.50 (241)
Overall OD: 4.25 (108)
End 1 ID: 3.13 (79)

HF28764 PARKER 932629Q



Overall Height: 9.25 (235)
Overall OD: 2.44 (62)
End 1 ID: 1.46 (37)

HF28766 PURO TEC V0191B2R03,
VICKERS V0191B2R03



Overall Height: 8.07 (205)
Largest OD: 3.72 (94)
Thread Size: 1 1/8-16 UN-2B

HF28767 VICKERS V0191B2R10,
PURO TEC V0191B2R10



Overall Height: 8.07 (205)
Largest OD: 3.72 (94)
Thread Size: 1 1/8-16 UN-2B

HF28778 FACET 1746925



HF28783 DENSO 3267012620



Overall Height: 3.50 (89)
Largest OD: 3.05 (77)
BPV Setting: 29.00 (200)
Thread Size: 3/4-16 UNF-2B

HF28793 CASE C2950511



Overall Height: 15.08 (383)
Overall OD: 2.87 (73)
BPV Setting: 87.02 (600)
End 1 ID: 1.31 (33)

HF28794 ARGO P2092301



Overall Height: 8.98 (228)
Overall OD: 3.27 (83)
End 1 ID: 1.97 (50)

HF28795 ARGO P2113321



Overall Height: 12.91 (328)
Overall OD: 4.33 (110)
End 1 ID: 2.84 (72)

HF28796 ARGO P3062051



Overall Height: 7.84 (199)
Overall OD: 2.32 (59)
BPV Setting: 25.38 (175)
End 1 ID: 1.06 (27)

HF28802 ARGO P3071301



Overall Height: 5.28 (134)
Overall OD: 2.76 (70)
End 1 ID: 1.02 (26)

HF28803 VOLVO CONSTRUCTION
EQUIPMENT 11026932



Overall Height: 11.42 (290)
Overall OD: 4.96 (126)
End 1 ID: 0.35 (9)
End 2 ID: 3.62 (92)

HF28804 VOLVO CONSTRUCTION
EQUIPMENT 11026934

















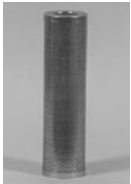

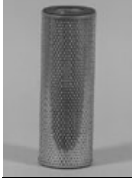





Overall Height: 11.42 (290)
Overall OD: 4.96 (126)
End 1 ID: 0.35 (9)
End 2 ID: 3.62 (92)

HF28805 VOLVO CONSTRUCTION
EQUIPMENT 11026936

























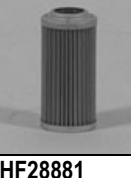

Overall Height: 15.35 (390)
Overall OD: 4.96 (126)
End 1 ID: 0.35 (9)
End 2 ID: 3.62 (92)



























E. PRODUCT GUIDE

HF28806 RENAULT V.I. 5010197266 Overall Height: 8.31 (211) Largest OD: 3.68 (94) ADBV: Yes BPV Setting: 36.26 (250) Thread Size: 1-12 UNF-2B	HF28818 MANN & HUMMEL WD9505  Overall Height: 6.87 (175) Largest OD: 3.68 (94) BPV Setting: 36.26 (250) Thread Size: 1-12 UNF-2B	HF28857 CLARK 247052  Overall Height: 6.87 (175) Largest OD: 3.68 (94) BPV Setting: 36.26 (250) Thread Size: 2-16 UN-2B
HF28808 JOHN DEERE RT6005003244  Overall Height: 4.57 (116) Overall OD: 1.99 (51) End 1 ID: 0.92 (23)	HF28833 FIATAGRI 1930986  Overall Height: 7.15 (182) Largest OD: 4.33 (110) BPV Setting: 10.15 (70) Thread Size: M40 X 2-6H INT	HF28858 ARGO P2093301  Overall Height: 12.95 (329) Overall OD: 3.50 (89) End 1 ID: 1.97 (50)
HF28809 ARGO V3093308  Overall Height: 13.11 (333) Overall OD: 3.54 (90) End 1 ID: 1.54 (39)	HF28834 VME (VOLVO) BM/MICH/EUCLID 14268262  Overall Height: 10.04 (255) Overall OD: 3.60 (92) End 1 ID: 1.97 (50)	HF28859 KHD(KLOCKNER-HUMBOLDT-DEUTZ) 4411051  Overall Height: 5.61 (143) Largest OD: 3.68 (94) BPV Setting: 36.26 (250) Thread Size: 3/4-16 UNF-2B
HF28810 NEW HOLLAND 86539970  Overall Height: 6.72 (171) Largest OD: 5.08 (129) Thread Size: 1 1/2-16 UN-2B	HF28835 HITACHI 4294130  Gasket: 3905774 Overall Height: 1.99 (51) Overall OD: 1.65 (42) End 1 ID: 0.83 (21)	HF28860 HSW-HUTA STALOWA WOLA-POLAND 25G90160  Overall Height: 6.22 (158) Overall OD: 3.54 (90) End 1 ID: 1.40 (36)
HF28811 MASSEY-FERGUSON 3619594M1  Overall Height: 6.30 (160) Overall OD: 1.99 (51) End 1 ID: 0.92 (23)	HF28836 FIAT HITACHI 4294135  Gasket: 3905774 Overall Height: 3.45 (88) Overall OD: 1.65 (42) End 1 ID: 0.83 (21)	HF28864 KHD(KLOCKNER-HUMBOLDT-DEUTZ) 4417454  Overall Height: 8.98 (228) Overall OD: 3.94 (100) End 1 ID: 2.32 (59)
HF28812 MASSEY-FERGUSON 3595175M1  Overall Height: 5.75 (146) Largest OD: 3.98 (101) Thread Size: M24 X 2-6H INT	HF28848 LIEBHERR 7366869  Overall Height: 32.91 (836) Overall OD: 5.98 (152) End 1 ID: 3.47 (88) End 2 ID: 1.87 (48)	HF28866 FBO CR506 The height includes a spring of 65mm  Gasket: 3326042 Overall Height: 5.59 (142) Overall OD: 2.76 (70) BPV Setting: 33.36 (230) End 1 ID: 1.14 (29)
HF28813 RENAULT D.M.A. 6005003243  Overall Height: 8.19 (208) Overall OD: 1.99 (51) End 1 ID: 0.92 (23)	HF28850 HYUNDAI 31E90126  Overall Height: 5.19 (132) Largest OD: 3.73 (95) Thread Size: 1 1/8-16 UN-2B	HF28868 FBO CR1256 The height includes a spring of 81mm  Gasket: 3326043 Overall Height: 9.92 (252) Overall OD: 3.74 (95) BPV Setting: 30.46 (210) End 1 ID: 1.61 (41)
HF28816 ZETTELMEYER 2289977  Overall Height: 8.90 (226) Overall OD: 2.76 (70) BPV Setting: 36.26 (250) End 1 ID: 1.63 (42)	HF28853 MANITOU 189195  Overall Height: 4.92 (125) Largest OD: 3.05 (78) BPV Setting: 23.21 (160) Thread Size: 13/16-16 UN-2B	HF28869 FBO CR1806 The height includes a spring of 81mm  Gasket: 3326043 Overall Height: 11.50 (292) Overall OD: 3.74 (95) BPV Setting: 34.81 (240) End 1 ID: 1.61 (41)

























E. PRODUCT GUIDE

HF28870  FBO CR2206 The height includes a spring of 115 mm Gasket: 3326040 Overall Height: 10.00 (254) Overall OD: 5.51 (140) BPV Setting: 34.81 (240) End 1 ID: 2.58 (66)	HF28891  CASE A167726, CASE A176593 Overall Height: 7.18 (182) End 1 OD: 4.55 (116) End 2 OD: 4.53 (115) End 1 ID: 0.52 (13)	HF28910  HITACHI 4333469 Overall Height: 17.68 (449) Overall OD: 7.01 (178) End 1 ID: 4.23 (107)
HF28872  FBO CR3256 The height includes a spring of 110 mm Gasket: 3326044 Overall Height: 12.36 (314) Overall OD: 5.51 (140) BPV Setting: 34.81 (240) End 1 ID: 2.01 (51)	HF28892  GEHL L99440 Overall Height: 6.05 (154) Largest OD: 3.95 (100) Thread Size: 1 3/8-12 UNF-2B	HF28911  MUSTANG MFG. CO. 17034895 Overall Height: 9.50 (241) Largest OD: 3.95 (100) Thread Size: 1 1/2-16 UN-2B
HF28873  FBO CR3306 The height includes a spring of 110 mm Gasket: 3326040 Overall Height: 12.36 (314) Overall OD: 5.51 (140) BPV Setting: 37.71 (260) End 1 ID: 2.58 (66)	HF28893  KOMATSU 1136023160 Overall Height: 8.50 (216) Largest OD: 4.33 (110)	HF28912  FIATAGRI 1909143 Overall Height: 3.96 (101) End 1 OD: 1.87 (48) End 2 OD: 1.77 (45) End 2 ID: 0.98 (25)
HF28874  FBO CR5006 The height includes a spring of 110 mm Gasket: 3326040 Overall Height: 12.36 (314) Overall OD: 5.51 (140) BPV Setting: 39.16 (270) End 1 ID: 2.58 (66)	HF28894  KOMATSU 21N6012210 Overall Height: 11.50 (292) Overall OD: 5.00 (127) End 1 ID: 1.75 (44)	HF28913  YANMAR 17214173760 Overall Height: 7.05 (179) Overall OD: 3.50 (89) End 1 ID: 2.36 (60)
HF28879  HITACHI 4185299 Overall Height: 12.01 (305) Overall OD: 5.51 (140) End 1 ID: 1.16 (29) End 2 ID: 0.79 (20)	HF28900  CATERPILLAR 1R0746 Overall Height: 5.62 (143) Overall OD: 2.88 (73) End 1 ID: 1.06 (27)	HF28914  FIATAGRI 1930882 Overall Height: 8.74 (222) Overall OD: 4.02 (102) End 1 ID: 1.63 (42)
HF28880  KOMATSU 2093812470 Overall Height: 3.46 (88) Overall OD: 1.65 (42) End 1 ID: 0.91 (23)	HF28905  LEACH 101348 Overall Height: 3.88 (98) Overall OD: 3.50 (89) End 1 ID: 1.50 (38)	HF28915  FIAT HITACHI 76028203 Overall Height: 3.37 (86) Overall OD: 2.13 (54) End 1 ID: 1.04 (27)
HF28881  NEW HOLLAND 81869132 Overall Height: 8.32 (211) Largest OD: 3.82 (97) BPV Setting: 14.50 (100) Thread Size: 1 1/8-16UNF-2B	HF28906  LEACH 100696 Length: 7.00 (178) Width: 4.00 (102)	HF28916  CASE 150794A1 Overall Height: 5.07 (129) Largest OD: 3.69 (94) Thread Size: 1 1/8-16 UN-2B
HF28885  NEW HOLLAND 82005016 NEW HOLLAND 81865736 Overall Height: 9.35 (238) Largest OD: 5.39 (137) BPV Setting: 15.95 (110) Thread Size: 1 3/4-16	HF28907  LEACH 107408 Overall Height: 9.06 (230) Overall OD: 3.63 (92) End 1 ID: 1.75 (44)	HF28917  SCANIA 1381235 Overall Height: 4.20 (107) Overall OD: 3.31 (84) End 1 ID: 0.79 (20)
	HF28909  HITACHI 4325820 Overall Height: 17.68 (449) Overall OD: 5.91 (150) End 1 ID: 4.33 (110)	HF28918  ZETOR 53420903 Overall Height: 8.98 (228) Largest OD: 5.04 (128) BPV Setting: 5.80 (40) Thread Size: 1 1/4 BSP

E. PRODUCT GUIDE

HF28919  MASSEY-FERGUSON 3619712M1 Overall Height: 6.79 (173) Largest OD: 5.35 (136) Thread Size: M45 X 2-6H INT	HF28932  JOHN DEERE AT186554 Gasket: 3913068S ¹⁰ Overall Height: 6.00 (152) Overall OD: 1.98 (50) End 1 ID: 0.92 (23)	HF28946  KUBOTA 68651-62120 Overall Height: 7.80 (198) Overall OD: 3.54 (90) BPV Setting: 29.01 (200) Thread Size: 1
HF28921  JOHN DEERE AT38431 Overall Height: 5.85 (149) Largest OD: 3.75 (95) Thread Size: 1-12 UNF-2B	HF28934  SAME 244193200 Overall Height: 10.26 (261) Largest OD: 4.25 (108) Thread Size: M40 X 2-6H INT	HF28948  J.C.B. 32913500 Overall Height: 8.96 (228) Overall OD: 2.36 (60) BPV Setting: 43.51 (300) End 1 ID: 1.29 (33) End 2 ID: 0.77 (20)
HF28922  GMC 6436232, AC PF16, CASE 1276810C1 Overall Height: 5.85 (149) Largest OD: 3.69 (94) Thread Size: 1-12 UNF-2B	HF28935  SAME 244193500 Overall Height: 7.34 (187) Largest OD: 4.25 (108) Thread Size: M40 X 2-6H INT	HF28949  CASE R51643 Overall Height: 9.00 (229) Overall OD: 4.52 (115) End 1 ID: 0.53 (13) End 2 ID: 2.25 (57)
HF28925  HITACHI 4210224 Overall Height: 5.19 (132) Overall OD: 5.88 (149) End 1 ID: 3.50 (89) Thread Size: M10 X 1.5-6H INT	HF28937  ALLISON 29509723 (HF28943 Kit contains 2-HF28937 plus gasket kit to service Allison Transmission)	HF28951  TOYOTA 675023288171 Overall Height: 7.45 (189) Largest OD: 3.91 (99) Thread Size: 1 X 11 BSP
HF28926  KOMATSU 20Y6021470 Overall Height: 0.89 (23) Overall OD: 1.87 (48) End 1 ID: 1.36 (35)	HF28938  CATERPILLAR 4I3948 Overall Height: 5.52 (140) Largest OD: 3.13 (80) Thread Size: 2-12 UN-2B	HF28952  RYCO R14, BALDWIN BT841 Product may not be available in all regions of the world. Overall Height: 5.19 (132) Largest OD: 3.80 (97) Thread Size: 1 X 11 BSP
HF28927  HITACHI 3035092 Overall Height: 8.50 (216) Overall OD: 7.88 (200) End 1 ID: 4.88 (124) End 2 ID: 4.50 (114)	HF28939  CASE K210049 Overall Height: 4.63 (118) End 1 OD: 3.12 (79) End 2 OD: 3.11 (79) End 2 ID: 1.67 (42)	HF28961  CASE 1976934C3, CASE 1976934C5, CASE 1976934C4 Uses service part: 3916150S Overall Height: 7.87 (200) Largest OD: 5.08 (129) Thread Size: 1 1/2-16 UN-2B
HF28928  KOMATSU 2856217320 Overall Height: 2.00 (51) Overall OD: 2.00 (51) End 1 ID: 1.50 (38)	HF28943  ALLISON 29526898 Kit contains two elements and gasket package to service transmission. (Filter element part number sold separately: HF28937 and gasket package 99274K)	HF28974  Nelson 84305A Overall Height: 14.49 (368) Overall OD: 6.00 (152) End 1 ID: 3.50 (89)
HF28929  CASE 1329214C1 Gasket: 332418 Overall Height: 10.71 (272) Largest OD: 5.08 (129) Thread Size: 1 1/2-16 UN-2B	HF28945  YANMAR 17263873730 Overall Height: 3.92 (100) Largest OD: 3.15 (80) Thread Size: 3/4-16 UNF-2B	HF28975  KOMATSU 706351142 Upgrade of HF6356 Overall Height: 11.81 (300) Overall OD: 5.91 (150) End 1 ID: 4.33 (110)
HF28931  HITACHI 4190987 Overall Height: 3.50 (89) Overall OD: 5.94 (151) End 1 ID: 2.94 (75)	HF28977  KOMATSU 706351100 Upgrade of HF6101 Overall Height: 11.50 (292) Overall OD: 5.10 (130) End 1 ID: 3.35 (85)	

E. PRODUCT GUIDE

<p>HF28978 KOMATSU 706351210 Upgrade of HF6319</p>  <p>Overall Height: 17.87 (454) Overall OD: 5.91 (150) End 1 ID: 4.33 (110)</p>	<p>HF28994 DONALDSON P173521, BALDWIN BT8871MPG</p>  <p>Overall Height: 11.63 (295) Largest OD: 4.77 (121) Thread Size: 1 3/4-12 UN-2B</p>	<p>HF29035 JOHN DEERE AT305049</p>  <p>Overall Height: 8.92 (227) Largest OD: 4.72 (120) Thread Size: M90 X 2-7H INT</p>
<p>HF28979 KOMATSU 706351054 Upgrade of HF6354</p>  <p>Overall Height: 8.26 (210) Overall OD: 3.94 (100) End 1 ID: 2.33 (59)</p>	<p>HF28996 CLARK 4202525</p>  <p>Overall Height: 5.97 (152) Largest OD: 3.82 (97) Thread Size: 2-16 UN 2B</p>	<p>HF30000 PALL HC9601FUP4H</p>  <p>Overall Height: 4.61 (117) Overall OD: 3.15 (80) End 1 ID: 1.66 (42)</p>
<p>HF28982 DOMANGE FD45P10</p>  <p>Overall Height: 8.86 (225) Overall OD: 3.62 (92) End 1 ID: 0.45 (12) End 2 ID: 2.52 (64)</p>	<p>HF28997 SCHROEDER KKS7</p>  <p>Overall Height: 18.19 (462) Overall OD: 3.89 (99) End 1 ID: 1.81 (46)</p>	<p>HF30002 Replaces ST 3960SGCB08</p>  <p>Overall Height: 8.21 (209) Overall OD: 3.15 (80) End 1 ID: 1.66 (42)</p>
<p>HF28988 TOYOTA 675012332071</p>  <p>Overall Height: 3.90 (99) Largest OD: 3.21 (81) Thread Size: 34MM 2.5 THRD. PITCH</p>	<p>HF28999 NELSON A70919A</p>  <p>Overall Height: 9.62 (244) Overall OD: 3.00 (76) End 1 ID: 1.53 (39) End 2 ID: 1.65 (42)</p>	<p>HF30003 MP FILTRI 6011022</p>  <p>Overall Height: 8.21 (209) Overall OD: 3.15 (80) End 1 ID: 1.66 (42)</p>
<p>HF28989 BOMAG 5821213LINDE 9830615 BOMAG 05821213</p>  <p>Overall Height: 6.87 (175) Largest OD: 3.68 (94) BPV Setting: 50.76 (350) Thread Size: 1-12 UNF-2B</p>	<p>HF29000 NEW HOLLAND 86016760</p>  <p>Overall Height: 7.66 (195) Largest OD: 4.72 (120) Thread Size: M90 X 2-7H INT</p>	<p>HF30006 Replaces ST 3960SGCB16</p>  <p>Overall Height: 16.93 (430) Overall OD: 3.15 (80) End 1 ID: 1.66 (42)</p>
<p>HF28991 PECO PP6185</p>  <p>Overall Height: 18.00 (457) Overall OD: 6.01 (153) End 1 ID: 3.46 (88)</p>	<p>HF29031 JOHN DEERE AT189924</p>  <p>Overall Height: 8.92 (227) Largest OD: 5.24 (133) Thread Size: M90 X 2-7H INT</p>	<p>HF30008 PALL HC7400SKN4H, SCHROEDER SBF74004Z5B</p>  <p>Overall Height: 5.82 (148) Largest OD: 3.72 (94) Thread Size: 1 1/2-16 UN-2B</p>
<p>HF28992 DONALDSON P171298, KAWASAKI 3098170080</p>  <p>Overall Height: 9.44 (240) Largest OD: 3.81 (97) Thread Size: 13/8-12 UNF-2B</p>	<p>HF29033 JOHN DEERE AT308274</p>  <p>Overall Height: 11.71 (297) Largest OD: 4.72 (120) Thread Size: M90 X 2-7H INT</p>	<p>HF30009 PALL HC7400SKN8H, SCHROEDER SBF74008Z5B</p>  <p>Gasket: 3830110¹⁰ Overall Height: 8.02 (204) Largest OD: 3.72 (94) Thread Size: 1 1/2-16 UN-2B</p>
<p>HF28993 CATERPILLAR 4I3950</p>  <p>Overall Height: 9.52 (242) Largest OD: 3.13 (80) Thread Size: 2-12UN-2B</p>	<p>HF29034 JOHN DEERE AT228474</p>  <p>Overall Height: 11.71 (297) Largest OD: 4.72 (120) Thread Size: M90 X 2-7H INT</p>	<p>HF30013 PUROLATOR 3849302</p>  <p>Overall Height: 3.46 (88) Overall OD: 1.62 (41) End 1 ID: 0.86 (22)</p>

E. PRODUCT GUIDE

HF30014 PALL HC7400SKS4H, SCHROEDER SBF74004Z10B



Overall Height: 5.82 (148)
Largest OD: 3.72 (94)
Thread Size: 1 1/2-16 UN-2B

HF30016 PARKER PR3032



Overall Height: 3.71 (94)
Overall OD: 1.36 (35)
End 1 ID: 0.49 (12)

HF30021 PALL HC9800FKN4Z



Overall Height: 4.44 (113)
Overall OD: 1.98 (50)
End 1 ID: 0.92 (23)

HF30022 PALL HC9800FDN4H, PALL HC9800FKN4H



Overall Height: 4.44 (113)
Overall OD: 1.98 (50)
End 1 ID: 0.92 (23)

HF30027 PALL AC9999FKN12Z, PALL HC9020FKN4Z, PALL HC9020FDN4Z



Overall Height: 4.47 (114)
End 1 OD: 1.78 (45)
End 2 OD: 1.75 (44)
End 2 ID: 0.98 (25)

HF30028 PALL HC9020FDN4H, PALL HC9020FKN4H Upgrade of HF7041



Gasket: 3913044 (1)
Overall Height: 4.47 (114)
End 1 OD: 1.78 (45)
End 2 OD: 1.75 (44)
End 2 ID: 0.98 (25)

HF30033 PALL HC2216FKN4H



Overall Height: 4.53 (115)
Overall OD: 2.74 (70)
End 1 ID: 1.34 (34)

HF30034 PALL HC8700FKN4H



Overall Height: 4.73 (120)
Overall OD: 2.06 (52)
End 1 ID: 0.92 (23)

HF30036 PALL HC9600FDN4H, PALL HC9600FKN4H Upgrade of HF7065



Overall Height: 4.60 (117)
End 1 OD: 3.12 (79)
End 2 OD: 3.11 (79)
End 2 ID: 1.67 (42)

HF30042 PALL HC2206FKN6H

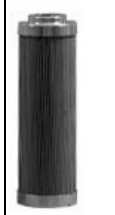

Overall Height: 6.02 (153)
End 1 OD: 1.86 (47)
End 2 OD: 1.88 (48)
End 1 ID: 0.87 (22)

HF30047 HYDAC 240D005BHHC



Overall Height: 6.81 (173)
End 1 OD: 2.74 (70)
End 2 OD: 2.73 (69)
End 2 ID: 1.34 (34)

HF30054 HYDAC 330D010BNHC



Overall Height: 6.47 (164)
End 1 OD: 3.59 (91)
End 2 OD: 3.58 (91)
End 1 ID: 1.89 (48)

HF30062 PALL HC9020FDN8H, PALL HC9020FKN8H, HY-PRO HP20L812M Upgrade of HF7045

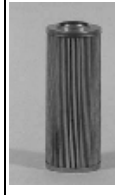

Gasket: 3913044 (1)
Overall Height: 8.08 (205)
End 1 OD: 1.78 (45)
End 2 OD: 1.75 (44)
End 2 ID: 0.98 (25)

HF30063 PALL HC9020FKN8Z

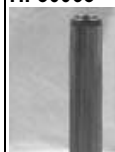

Overall Height: 8.08 (205)
End 1 OD: 1.75 (44)
End 2 OD: 1.78 (45)
End 2 ID: 0.98 (25)

HF30065 FAIREY ARLON 170L122A



Overall Height: 2.60 (66)
Overall OD: 2.17 (55)
End 1 ID: 0.72 (18)

HF30068 PALL HC8800FDN8Z

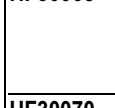

Overall Height: 8.16 (207)
Overall OD: 3.39 (86)
End 1 ID: 1.93 (49)

HF30070 PALL HC8900FDN8H, PALL HC8900FKN8H



Overall Height: 8.22 (209)
Overall OD: 3.79 (96)
End 1 ID: 2.18 (55)

HF30071 PALL HC9800FDN8H, PALL HC9800FKN8H Upgrade of HF7105



Overall Height: 8.21 (209)
Overall OD: 1.98 (50)
End 1 ID: 0.92 (23)

HF30072 PALL HC9800FKN8Z



Overall Height: 8.21 (209)
Overall OD: 1.98 (50)
End 1 ID: 0.92 (23)

HF30073 PALL HC8500FKN8H



Overall Height: 8.06 (205)
Overall OD: 3.78 (96)
End 1 ID: 1.70 (43)

HF30074 PALL HC8500FKN8Z

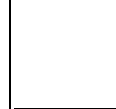

Overall Height: 8.06 (205)
Overall OD: 3.78 (96)
End 1 ID: 1.70 (43)

HF30075 PALL HC8700FKN8H

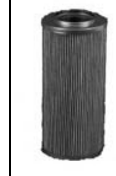

Overall Height: 8.38 (213)
Overall OD: 2.06 (52)
End 1 ID: 0.92 (23)

HF30077 PALL MC8200FKN8H

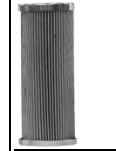

Overall Height: 8.13 (207)
End 1 OD: 3.25 (83)
End 2 OD: 3.19 (81)
End 1 ID: 1.49 (38)

HF30078 PALL HC8200FKN8Z, ALLISON 29510918



Overall Height: 8.13 (207)
End 1 OD: 3.25 (83)
End 2 OD: 3.19 (81)
End 1 ID: 1.49 (38)

HF30079 PALL HC6400FKN8H

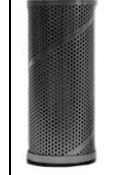

Overall Height: 8.25 (210)
End 1 OD: 3.41 (87)
End 2 OD: 3.39 (86)
End 1 ID: 1.95 (50)

HF30081 PALL HC6300FKN8H



Overall Height: 8.25 (210)
End 1 OD: 3.14 (80)
End 2 OD: 3.12 (79)
End 1 ID: 1.61 (41)

HF30083 PALL HC9600FKN8Z

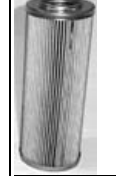















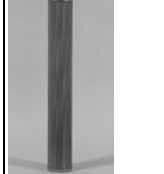

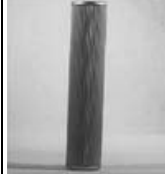
Overall Height: 8.21 (209)
End 1 OD: 3.12 (79)
End 2 OD: 3.11 (79)
End 2 ID: 1.67 (42)

HF30084 Upgrade of HF7069



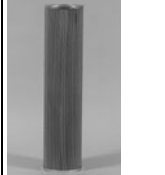







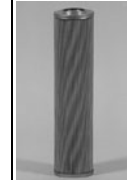



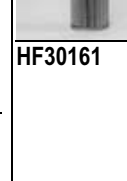





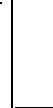

Overall Height: 8.21 (209)
End 1 OD: 3.12 (79)
End 2 OD: 3.11 (79)
End 2 ID: 1.67 (42)

E. PRODUCT GUIDE

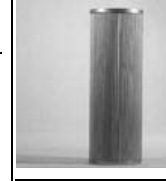
HF30085  PALL HC9650FKN8H Overall Height: 8.36 (212) Overall OD: 3.10 (79) End 1 ID: 1.67 (42)	HF30110  PALL HC6300FKN16H Overall Height: 16.81 (427) End 1 OD: 3.14 (80) End 2 OD: 3.12 (79) End 1 ID: 1.61 (41)	HF30127  PALL HC6400FKN26H Overall Height: 25.81 (656) End 1 OD: 3.41 (87) End 2 OD: 3.39 (86) End 1 ID: 1.95 (50)
HF30089 PALL HC9700FKN9H Overall Height: 9.22 (234) Overall OD: 3.91 (99) End 1 ID: 1.61 (41)	HF30112  PALL HC8800FKN16H, PALL MC8800FDN16H, PALL MC8800FKN16H Upgrade of HF7130 Overall Height: 16.89 (429) Overall OD: 3.39 (86) End 1 ID: 1.93 (49)	HF30129 PALL HC6300FKN26H Overall Height: 25.81 (656) End 1 OD: 3.14 (80) End 2 OD: 3.12 (79) End 1 ID: 1.61 (41)
HF30095 FAIREY ARLON 270Z221A, FAIREY ARLON 270L221A Overall Height: 9.29 (236) Overall OD: 2.90 (74) End 1 ID: 1.27 (32)	HF30114  PALL HC8900FKN16Z Upgrade of HF7520 Beta 200 at 6 microns Overall Height: 16.84 (428) Overall OD: 3.79 (96) End 1 ID: 2.18 (55)	HF30131  PALL HC9400FKN26H Upgrade of HF7057 Overall Height: 25.92 (658) Overall OD: 3.79 (96) End 1 ID: 2.18 (55)
HF30098  FAIREY ARLON 370Z321A, FAIREY ARLON 370L321A Overall Height: 12.66 (322) Overall OD: 3.70 (94) End 1 ID: 1.86 (47)	HF30115  PALL HC8900FDN16H, PALL HC8900FKN16H Overall Height: 16.84 (428) Overall OD: 3.79 (96) End 1 ID: 2.18 (55)	HF30132 PALL HC9400FUN26Z Overall Height: 25.92 (658) Overall OD: 3.79 (96) End 1 ID: 2.18 (55)
HF30100  PALL HC2233FKN13H Overall Height: 13.01 (330) Overall OD: 3.59 (91) End 1 ID: 1.89 (48)	HF30116  PALL HC9600FKN16H Overall Height: 16.86 (428) End 1 OD: 3.12 (79) End 2 OD: 3.11 (79) End 2 ID: 1.67 (42)	HF30133 PALL HC8500FKN26Z Overall Height: 25.62 (651) Overall OD: 3.78 (96) End 1 ID: 1.67 (42)
HF30103 PALL HC8200FKN16H Overall Height: 16.59 (421) End 1 OD: 3.25 (83) End 2 OD: 3.19 (81) End 1 ID: 1.49 (38)	HF30119 PALL HC9650FKN16Z Overall Height: 17.01 (432) Overall OD: 3.10 (79) End 1 ID: 1.67 (42)	HF30134  PALL HC8500FDN26H, PALL HC8500FKN26H Overall Height: 25.62 (651) Overall OD: 3.78 (96) End 1 ID: 1.67 (42)
HF30106  PALL HC6500FKN16H Overall Height: 16.81 (427) End 1 OD: 3.80 (97) End 2 OD: 3.79 (96) End 1 ID: 2.21 (56)	HF30121  Replaces ST 3970GGEB18 Overall Height: 18.43 (468) Overall OD: 3.91 (99) End 1 ID: 1.61 (41)	HF30135 PALL HC8900FKN26H Overall Height: 25.76 (654) Overall OD: 3.79 (96) End 1 ID: 2.18 (55)
HF30107  PALL HC8300FKN16Z, PALL HC8300FDN16Z Overall Height: 16.55 (420) Overall OD: 5.94 (151) End 1 ID: 4.11 (104) End 2 ID: 4.11 (104)	HF30123  PALL HC8400FKN26H Upgrade of HF7021 Overall Height: 25.62 (651) Overall OD: 5.98 (152) End 1 ID: 3.23 (82)	HF30136 PALL HC8400FKN26Z Overall Height: 25.76 (654) Overall OD: 3.79 (96) End 1 ID: 2.18 (55)
HF30108  INTERNORMEN 583006VG10PB16, PALL HC8300FKN16H Overall Height: 16.55 (420) Overall OD: 5.94 (151) End 1 ID: 4.11 (104)	HF30124  PALL HC8400FUN26Z Overall Height: 25.62 (651) Overall OD: 5.98 (152) End 1 ID: 3.23 (82)	HF30137  PALL HC9700FKN27H Overall Height: 27.77 (705) Overall OD: 3.91 (99) End 1 ID: 1.61 (41)
HF30109  PALL HC6400FKN16H Overall Height: 16.81 (427) End 1 OD: 3.41 (87) End 2 OD: 3.39 (86) End 1 ID: 1.95 (50)		HF30142 PALL HC8300FKN39Z Overall Height: 38.37 (975) Overall OD: 5.94 (151) End 1 ID: 4.11 (104)

E. PRODUCT GUIDE

HF30143  PALL HC8300FDN39H, PALL HC8300FKN39H, INTERNORMEN 583006VG10PB39 Overall Height: 38.37 (975) Overall OD: 5.94 (151) End 1 ID: 4.11 (104)	HF30158  PALL HC9600FKN13H, NELSON 87798N Overall Height: 12.94 (329) End 1 OD: 3.12 (79) End 2 OD: 3.11 (79) End 2 ID: 1.67 (42)	HF30187  PALL HC2206FKS3H Overall Height: 3.31 (84) End 1 OD: 1.88 (48) End 2 OD: 1.86 (47) End 2 ID: 0.87 (22)
HF30146 PALL HC9400FKN39H Overall Height: 38.93 (989) Overall OD: 3.79 (96) End 1 ID: 2.18 (55)	HF30159  PALL HC9600FKN13Z Overall Height: 12.94 (329) End 1 OD: 3.12 (79) End 2 OD: 3.11 (79) End 2 ID: 1.67 (42)	HF30188 Replaces ST STG1599  Overall Height: 3.15 (80) Overall OD: 2.40 (61) End 1 ID: 1.37 (35)
HF30147 FLUITEK PO383902U71 Overall Height: 38.93 (989) Overall OD: 3.79 (96) End 1 ID: 2.18 (55)	HF30161  PALL HC8200FKN13H Overall Height: 12.88 (327) End 1 OD: 3.25 (83) End 2 OD: 3.19 (81) End 1 ID: 1.49 (38)	HF30192  FAIREY ARLON 270L122A Overall Height: 4.06 (103) Overall OD: 2.87 (73) End 1 ID: 1.24 (32)
HF30148 PALL HC8400FKN39Z Overall Height: 38.67 (982) Overall OD: 5.99 (152) End 1 ID: 3.23 (82)	HF30162  PALL HC9800FKN13H Overall Height: 12.99 (330) Overall OD: 1.98 (50) End 1 ID: 0.92 (23)	HF30195  PALL HC7400SKP4H, SCHROEDER SBF74004Z3B Overall Height: 5.82 (148) Largest OD: 3.72 (94) Thread Size: 1 1/2-16 UN-2B
HF30151  PALL HC8800FDN13Z, PALL HC8800FKN13Z Overall Height: 12.97 (329) Overall OD: 3.39 (86) End 1 ID: 1.93 (49)	HF30174  PALL HC6300FKN13H, PALL HC6300FDN13H Overall Height: 12.93 (328) End 1 OD: 3.14 (80) End 2 OD: 3.12 (79) End 1 ID: 1.61 (41)	HF30196  PALL HC9800FDS4H, PALL HC9800FKS4H Overall Height: 4.44 (113) Overall OD: 1.98 (50) End 1 ID: 0.92 (23)
HF30153  PALL HC8900FDN13H, PALL HC8900FKN13H Overall Height: 12.96 (329) Overall OD: 3.79 (96) End 1 ID: 2.18 (55)	HF30177  PALL HC6400FKN13H Overall Height: 12.93 (328) End 1 OD: 3.41 (87) End 2 OD: 3.39 (86) End 1 ID: 1.95 (50)	HF30197  PALL HC9800FKS4Z Overall Height: 4.44 (113) Overall OD: 1.98 (50) End 1 ID: 0.92 (23)
HF30154  PALL HC8500FDN13H, PALL HC8500FKN13H Upgrade of HF7033 Overall Height: 12.80 (325) Overall OD: 3.78 (96) End 1 ID: 1.67 (42)	HF30179  PALL HC6500FKN13H Overall Height: 12.93 (328) End 1 OD: 3.80 (97) End 2 OD: 3.79 (96) End 1 ID: 2.21 (56)	HF30199  NORMAN EQUIPMENT 535FB10A, PALL HC9020FKS4H, NELSON 87829N Upgrade of HF7042 Gasket: 3913044 (1) Overall Height: 4.47 (114) End 1 OD: 1.78 (45) End 2 OD: 1.75 (44) End 2 ID: 0.98 (25)
HF30156 Upgrade of HF7053  Overall Height: 12.12 (308) Overall OD: 3.79 (96) End 1 ID: 2.18 (55)	HF30181  PALL HC8400FDN16H, PALL HC8400FKN16H, INTERNORMEN 584006VG10PB16 Overall Height: 16.85 (428) Overall OD: 5.99 (152) End 1 ID: 3.23 (82)	HF30204  PALL HC9021FUT4Z Overall Height: 4.47 (114) Overall OD: 1.79 (45) End 1 ID: 0.99 (25)
HF30157  PALL HC9400FKN13Z Overall Height: 13.12 (333) Overall OD: 3.79 (96) End 1 ID: 2.18 (55)	HF30182  MP PRODUCTS 6004024 Overall Height: 16.85 (428) Overall OD: 5.99 (152) End 1 ID: 3.23 (82)	HF30209  PALL HC8700FKS4H Overall Height: 4.73 (120) Overall OD: 2.06 (52) End 1 ID: 0.92 (23)

E. PRODUCT GUIDE

HF30210 PALL HC9600FDS4H Upgrade of HF7066



Overall Height: 4.60 (117)
End 1 OD: 3.12 (79)
End 2 OD: 3.11 (79)
End 2 ID: 1.67 (42)

HF30211 PALL HC9600FKS8Z



Overall Height: 4.60 (117)
End 1 OD: 3.12 (79)
End 2 OD: 3.11 (79)
End 2 ID: 1.67 (42)

HF30212 MP PRODUCTS 6012001



Overall Height: 4.62 (117)
End 1 OD: 3.12 (79)
End 2 OD: 3.11 (79)
End 2 ID: 1.67 (42)

HF30216 FAIREY ARLO 170Z222A, FAIREY ARLO 170L222A



Overall Height: 4.80 (122)
Overall OD: 2.17 (55)
End 1 ID: 0.74 (19)

HF30217 HYDAC 110D010BHHC



Overall Height: 6.02 (153)
Overall OD: 1.86 (47)
End 1 ID: 0.87 (22)

HF30218 PALL HC2206FKS6H



Overall Height: 6.02 (153)
End 1 OD: 1.88 (48)
End 2 OD: 1.86 (47)
End 2 ID: 0.87 (22)

HF30219 PALL HC2237FDT6H



Overall Height: 6.38 (162)
Overall OD: 3.59 (91)
End 1 ID: 1.89 (48)

HF30220 FAIREY ARLO 270Z222A

Overall Height: 9.29 (236)
Overall OD: 2.90 (74)
End 1 ID: 1.24 (32)

HF30221 PALL HC2217FDT6H



Overall Height: 6.81 (173)
End 1 OD: 2.74 (70)
End 2 OD: 2.73 (69)
End 2 ID: 1.34 (34)

HF30222 PALL HC2216FKS6H



Overall Height: 6.81 (173)
Overall OD: 2.74 (70)
End 1 ID: 1.34 (34)

HF30233 FAIREY ARLO 370L222A



Overall Height: 7.87 (200)
Overall OD: 3.70 (94)
End 1 ID: 1.88 (48)

HF30236 PALL HC9020FKS8H, PALL HC9020FDS8H Upgrade of HF7046



Gasket: 3913044 (1)
Overall Height: 8.08 (205)
End 1 OD: 1.78 (45)
End 2 OD: 1.75 (44)
End 2 ID: 0.98 (25)

HF30237 PARKER 932618Q



Overall Height: 8.08 (205)
End 1 OD: 1.78 (45)
End 2 OD: 1.75 (44)
End 2 ID: 0.98 (25)

HF30238 PALL HC7400SKP8H, SCHROEDER SBF74008Z3B
Not available in all parts of the world.



Overall Height: 8.02
Largest OD: 3.68
Thread Size: 1 1/2-16 UN-2B

HF30240 PALL HC8900FKS8Z

Overall Height: 8.22 (209)
Overall OD: 3.79 (96)
End 1 ID: 2.18 (55)

HF30241 PALL HC8900FKS8H

Overall Height: 8.22 (209)
Overall OD: 3.79 (96)
End 1 ID: 2.18 (55)

HF30244 PALL HC9800FDS8H, PALL HC9800FKS8H Upgrade of HF7106



Overall Height: 8.21 (209)
Overall OD: 1.98 (50)
End 1 ID: 0.92 (23)

HF30246 PALL HC8700FKS8H

Overall Height: 8.38 (213)
Overall OD: 2.06 (52)
End 1 ID: 0.92 (23)

HF30249 PALL HC8500FKS8Z

Overall Height: 25.63 (651)
Overall OD: 3.78 (96)
End 1 ID: 1.70 (43)

HF30250 PALL HC8800FKS8Z

Overall Height: 8.16 (207)
Overall OD: 3.39 (86)
End 1 ID: 1.93 (49)

HF30251 PALL HC8800FKS8H

Overall Height: 8.16 (207)
Overall OD: 3.39 (86)
End 1 ID: 1.93 (49)

HF30253 PALL HC8200FKS8H

Overall Height: 8.13 (207)
End 1 OD: 3.25 (83)
End 2 OD: 3.19 (81)
End 1 ID: 1.49 (38)

HF30254 PALL HC6400FKS8H



Overall Height: 8.25 (210)
End 1 OD: 3.41 (87)
End 2 OD: 3.39 (86)
End 1 ID: 1.95 (50)

HF30256 PALL HC6300FKS8H

Overall Height: 8.25 (210)
End 1 OD: 3.14 (80)
End 2 OD: 3.12 (79)
End 1 ID: 1.61 (41)

HF30259 PALL HC9606FKS8H

Overall Height: 8.21 (209)
End 1 OD: 3.12 (79)
End 2 OD: 3.11 (79)
End 2 ID: 1.67 (42)

HF30262 PALL HC9600FKS8H, VAPORMATIC VPK1580 Upgrade of HF7070



Overall Height: 8.21 (209)
End 1 OD: 3.12 (79)
End 2 OD: 3.11 (79)
End 2 ID: 1.67 (42)

HF30263 PALL HC9600FKS8Z

Overall Height: 8.21 (209)
End 1 OD: 3.12 (79)
End 2 OD: 3.11 (79)
End 2 ID: 1.67 (42)

HF30264 PALL HC9650FKS8H



Overall Height: 8.36 (212)
Overall OD: 3.10 (79)
End 1 ID: 1.67 (42)

HF30265 PALL HC9650FKS8Z













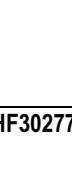

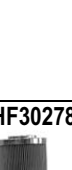





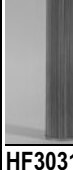
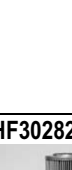

Overall Height: 8.36 (212)
Overall OD: 3.10 (79)
End 1 ID: 1.67 (42)

HF30267 SCHROEDER KSX7V



Overall Height: 9.18 (233)
Overall OD: 3.15 (80)
End 1 ID: 1.59 (40)

E. PRODUCT GUIDE

HF30268  PALL HC9700FKS9H Overall Height: 9.22 (234) Overall OD: 3.91 (99) End 1 ID: 1.61 (41)	HF30288  PALL HC9400FDS13H, PALL HC9400FKS13H Upgrade of HF7054 Overall Height: 13.12 (333) Overall OD: 3.79 (96) End 1 ID: 2.18 (55)	HF30304  PALL HC6300FKS16H Overall Height: 16.81 (427) End 1 OD: 3.14 (80) End 2 OD: 3.11 (79) End 1 ID: 1.61 (41)
HF30269  FAIREY ARLON 170Z120A, FAIREY ARLON 170L120A Overall Height: 2.66 (68) Overall OD: 2.17 (55) End 1 ID: 0.70 (18)	HF30289  PALL HC9400FKS13Z Overall Height: 13.12 (333) Overall OD: 3.79 (96) End 1 ID: 2.18 (55)	HF30306  PALL HC6500FKS16H Overall Height: 16.81 (427) End 1 OD: 3.80 (97) End 2 OD: 3.79 (96) End 1 ID: 2.21 (56)
HF30277  FAIREY ARLON 370L322A, FAIREY ARLON 370Z322A Overall Height: 12.66 (322) Overall OD: 3.70 (94) End 1 ID: 1.86 (47)	HF30290  PALL HC9800FKS13H Overall Height: 12.99 (330) Overall OD: 1.98 (50) End 1 ID: 0.92 (23)	HF30309  PALL HC8300FKS16H Overall Height: 16.55 (420) Overall OD: 5.94 (151) End 1 ID: 4.11 (104)
HF30278  PALL HC2237FDT13H Overall Height: 12.92 (328) Overall OD: 3.59 (91) End 1 ID: 1.89 (48)	HF30292  PALL HC8200FKS13H Overall Height: 12.88 (327) End 1 OD: 3.25 (83) End 2 OD: 3.19 (81) End 1 ID: 1.49 (38)	HF30310  Upgrade of HF7131 Overall Height: 16.89 (429) Overall OD: 3.39 (86) End 1 ID: 1.93 (49)
HF30279  PALL HC2233FKS13H Overall Height: 13.01 (330) Overall OD: 3.59 (91) End 1 ID: 1.89 (48)	HF30294  PALL HC9600FKS13H Overall Height: 12.95 (329) End 1 OD: 3.12 (79) End 2 OD: 3.11 (79) End 2 ID: 1.67 (42)	HF30312  PALL HC9600FKS16H Overall Height: 16.86 (428) End 1 OD: 3.12 (79) End 2 OD: 3.11 (79) End 2 ID: 1.67 (42)
HF30281  PALL HC8800FKS13Z Upgrade of HF7527 Overall Height: 12.97 (329) Overall OD: 3.39 (86) End 1 ID: 1.93 (49)	HF30295  PALL HC9600FKS13Z Overall Height: 12.95 (329) End 1 OD: 3.12 (79) End 2 OD: 3.11 (79) End 2 ID: 1.67 (42)	HF30314  PALL HC9650FKS16H Not available in all parts of the world. Overall Height: 17.01 (432) Overall OD: 3.10 (79) End 1 ID: 1.67 (42)
HF30282  PALL HC8900FKS13H Overall Height: 12.96 (329) Overall OD: 3.79 (96) End 1 ID: 2.18 (55)	HF30296  PALL HC9606FKS13Z Overall Height: 13.08 (332) End 1 OD: 3.12 (79) End 2 OD: 3.11 (79) End 2 ID: 1.67 (42)	HF30315  PALL HC9650FKS16Z Overall Height: 17.01 (432) Overall OD: 3.10 (79) End 1 ID: 1.67 (42)
HF30285  PALL HC8900FKS13Z Overall Height: 12.96 (329) Overall OD: 3.79 (96) End 1 ID: 2.18 (55)	HF30300  PALL HC8200FKS16H Overall Height: 16.59 (421) End 1 OD: 3.25 (83) End 2 OD: 3.19 (81) End 1 ID: 1.49 (38)	HF30316  PALL HC8900FKS16H Overall Height: 16.84 (428) Overall OD: 3.79 (96) End 1 ID: 2.18 (55)
HF30287  PALL HC8500FDS13H, PALL HC8500FKS13H Overall Height: 12.80 (325) Overall OD: 3.78 (96) End 1 ID: 1.67 (42)	HF30303  PALL HC6400FKS16H Overall Height: 16.81 (427) End 1 OD: 3.41 (87) End 2 OD: 3.39 (86) End 1 ID: 1.95 (50)	HF30317  PALL HC8900FKS16Z Overall Height: 16.84 (428) Overall OD: 3.79 (96) End 1 ID: 2.18 (55)

E. PRODUCT GUIDE

HF30318 PALL HC9700FKS18H



Overall Height: 18.43 (468)
Overall OD: 3.91 (99)
End 1 ID: 1.61 (41)

HF30319 HYDAC 60D003BHHC



Overall Height: 3.31 (84)
Overall OD: 1.86 (47)
End 1 ID: 0.87 (22)

HF30324 PALL HC6500FKS26H



Overall Height: 25.81 (656)
End 1 OD: 3.80 (97)
End 2 OD: 3.79 (96)
End 1 ID: 2.21 (56)

HF30325 PALL HC6400FKS26H



Overall Height: 25.81 (656)
End 1 OD: 3.41 (87)
End 2 OD: 3.39 (86)
End 1 ID: 1.95 (50)

HF30332 PALL HC9400FKS26Z



Overall Height: 25.92
Largest OD: 3.79
End 1 ID: 2.18

HF30335 PALL HC9700FKS27H



Overall Height: 27.77 (705)
Overall OD: 3.91 (99)
End 1 ID: 1.61 (41)

HF30340 PALL HC8300FKS39H
Upgrade of HF7010



Overall Height: 38.37 (975)
Overall OD: 5.94 (151)
End 1 ID: 4.11 (104)

HF30346 PALL HC9400FKS39H



Overall Height: 38.93 (989)
Overall OD: 3.79 (96)
End 1 ID: 2.18 (55)

HF30348 HYDAC 30D010BN



Overall Height: 3.71 (94)
Overall OD: 1.36 (35)
End 1 ID: 0.49 (12)

HF30357 VME (VOLVO
BM/MICH./EUCLID) 4099538



Overall Height: 12.93 (328)
End 1 OD: 3.14 (80)
End 2 OD: 3.12 (79)
End 1 ID: 1.61 (41)

HF30358 PALL HC6400FKS13H



Overall Height: 12.93 (328)
End 1 OD: 3.41 (87)
End 2 OD: 3.39 (86)
End 1 ID: 1.95 (50)

HF30363 PALL HC8400FKS16Z



Overall Height: 16.85 (428)
Overall OD: 5.99 (152)
End 1 ID: 3.23 (82)

HF30364 Replaces ST 3840DGH16



Overall Height: 16.85 (428)
Overall OD: 5.99 (152)
End 1 ID: 3.23 (82)

HF30367 FAIREY ARLON 370L122A



Overall Height: 3.98 (101)
Overall OD: 3.70 (94)
End 1 ID: 1.88 (48)

HF30369 PALL HC8400FDS8H, PALL
HC8400FKS8H,
INTERNORMEN
5840010VG10PB8

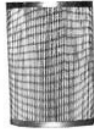

Overall Height: 8.17 (208)
Overall OD: 5.98 (152)
End 1 ID: 3.23 (82)

HF30370 PALL HC8400FKS8Z



Overall Height: 8.17 (208)
Overall OD: 5.98 (152)
End 1 ID: 3.23 (82)

HF30379 PALL HC2217FDP4H



Overall Height: 4.53 (115)
End 1 OD: 2.74 (70)
End 2 OD: 2.73 (69)
End 2 ID: 1.34 (34)

HF30381 PALL HC2216FKP4H



Overall Height: 4.53 (115)
Overall OD: 2.74 (70)
End 1 ID: 1.34 (34)

HF30383 Upgrade of HF7040



Gasket: 3913044 (1)
Overall Height: 4.47 (114)
End 1 OD: 1.78 (45)
End 2 OD: 1.75 (44)
End 2 ID: 0.98 (25)

HF30389 PALL HC9800FKP4H



Overall Height: 4.44 (113)
Overall OD: 1.98 (50)
End 1 ID: 0.92 (23)

HF30395 PALL HC9601FDT4Z Not
available in all parts of the
world.



Overall Height: 4.61 (117)
Overall OD: 3.15 (80)
End 1 ID: 1.66 (42)

HF30396 PALL HC9601FDT8Z



Overall Height: 8.21 (209)
Overall OD: 3.15 (80)
End 1 ID: 1.66 (42)

HF30399 PALL HC7400SKT4H,
SCHROEDER SBF74004Z25B



Overall Height: 5.82 (148)
Largest OD: 3.72 (94)
Thread Size: 1 1/2-16 UN-2B

HF30400 PALL HC7400SKT8H,
SCHROEDER SBF74008Z25B,
SCHROEDER SBVF74008Z25B
Not available in all parts of the
world.



Overall Height: 8.02 (204)
Largest OD: 3.72 (94)
Thread Size: 1 1/2-16 UN-2B

HF30402 PALL HC9600FKP4H Upgrade
of HF7064

















Overall Height: 4.60 (117)
End 1 OD: 3.12 (79)
End 2 OD: 3.11 (79)
End 2 ID: 1.67 (42)

HF30406 HYDAC 110D003BHHC

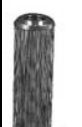
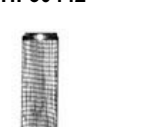
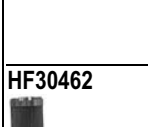

Overall Height: 6.02 (153)
Overall OD: 1.86 (47)
End 1 ID: 0.87 (22)

E. PRODUCT GUIDE

HF30426  Replaces ST 3902SGCV04 Overall Height: 4.47 (114) Overall OD: 1.79 (45) End 1 ID: 0.99 (25)	HF30453  PALL HC9600FKP8H Upgrade of HF7068 Overall Height: 8.21 (209) End 1 OD: 3.12 (79) End 2 OD: 3.11 (79) End 2 ID: 1.67 (42)	HF30483 PALL HC6300FKP8H Overall Height: 8.25 (210) End 1 OD: 3.14 (80) End 2 OD: 3.12 (79) End 1 ID: 1.61 (41)
HF30434  PALL HC8700FKP4H Overall Height: 4.73 (120) Overall OD: 2.06 (52) End 1 ID: 0.92 (23)	HF30454  PALL HC9600FKP8Z Upgrade of HF7468 Overall Height: 8.21 (209) End 1 OD: 3.12 (79) End 2 OD: 3.11 (79) End 2 ID: 1.67 (42)	HF30490  PALL HCS630KUP9H Overall Height: 9.23 (234) Overall OD: 3.91 (99) End 1 ID: 1.61 (41)
HF30435 PALL HC8700FKP8H Overall Height: 8.38 (213) Overall OD: 2.06 (52) End 1 ID: 0.92 (23)	HF30455  PALL HC9650FKP8H Overall Height: 8.36 (212) Overall OD: 3.10 (79) End 1 ID: 1.67 (42)	HF30491  PALL HC9700FKP9H Overall Height: 9.22 (234) Overall OD: 3.91 (99) End 1 ID: 1.61 (41)
HF30436  Upgrade of HF7044 Gasket: 3913044 (1) Overall Height: 8.08 (205) End 1 OD: 1.78 (45) End 2 OD: 1.75 (44) End 2 ID: 0.98 (25)	HF30457 Upgrade of HF7121 Not available in all parts of the world. Overall Height: 8.16 (207) Overall OD: 3.39 (86) End 1 ID: 1.93 (49)	HF30504  PALL HC2237FDP13H Overall Height: 12.92 (328) Overall OD: 3.59 (91) End 1 ID: 1.89 (48)
HF30442  Upgrade of HF7104 Overall Height: 8.21 (209) Overall OD: 1.98 (50) End 1 ID: 0.92 (23)	HF30462  PALL HC9801FDT8H Overall Height: 8.18 (208) Overall OD: 1.98 (50) End 1 ID: 0.93 (24)	HF30505 PALL HC2233FKP13H Overall Height: 13.01 (330) Overall OD: 3.59 (91) End 1 ID: 1.89 (48)
HF30443 PALL HC9800FKP8Z Overall Height: 8.21 (209) Overall OD: 1.98 (50) End 1 ID: 0.92 (23)	HF30466 PALL HC8900FKP8H Overall Height: 8.22 (209) Overall OD: 3.79 (96) End 1 ID: 2.18 (55)	HF30508  Replaces ST 3960SGHB13 Overall Height: 12.99 (330) Overall OD: 3.15 (80) End 1 ID: 1.66 (42)
HF30448 PALL HC8200FKP8H Overall Height: 8.13 (207) End 1 OD: 3.25 (83) End 2 OD: 3.19 (81) End 1 ID: 1.49 (38)	HF30467 PALL HC8900FKP8Z Overall Height: 8.22 (209) Overall OD: 3.79 (96) End 1 ID: 2.18 (55)	HF30511 PALL HC8800FUP13Z Not available in all parts of the world. Overall Height: 12.97 (329) Overall OD: 3.39 (86) End 1 ID: 1.93 (49)
HF30451  PALL HC8500FDP8H, PALL HC8500FKP8H Upgrade of HF7028 Not available in all parts of the world. Overall Height: 8.06 (205) Overall OD: 3.78 (96) End 1 ID: 1.70 (43)	HF30473  PALL HC9801FUP8H Overall Height: 8.18 (208) Overall OD: 1.98 (50) End 1 ID: 0.93 (24)	HF30513 PALL HC8200FKP13H Overall Height: 12.88 (327) End 1 OD: 3.25 (83) End 2 OD: 3.19 (81) End 1 ID: 1.49 (38)
HF30452  PALL HC8500FKP8Z Overall Height: 8.06 (205) Overall OD: 3.78 (96) End 1 ID: 1.70 (43)	HF30480  STAUFF SP070F10B Overall Height: 8.21 (209) Overall OD: 3.15 (80) End 1 ID: 1.66 (42)	HF30514 PALL HC8500FKP13Z Overall Height: 12.80 (325) Overall OD: 3.78 (96) End 1 ID: 1.67 (42)
	HF30481 PALL HC6400FKP8H Overall Height: 8.25 (210) End 1 OD: 3.41 (87) End 2 OD: 3.39 (86) End 1 ID: 1.95 (50)	HF30516 PALL HC9400FKP13Z Overall Height: 13.12 (333) Overall OD: 3.79 (96) End 1 ID: 2.18 (55)

E. PRODUCT GUIDE

HF30518 PALL HC8900FKP13H



Overall Height: 12.96 (329)
Overall OD: 3.79 (96)
End 1 ID: 2.18 (55)

HF30519 PALL HC8900FKP13Z

Overall Height: 12.96 (329)
Overall OD: 3.79 (96)
End 1 ID: 2.18 (55)

HF30522 PALL HC9800FKP13H

Overall Height: 12.99 (330)
Overall OD: 1.98 (50)
End 1 ID: 0.92 (23)

HF30524 PALL HC9600FKP13H
Upgrade of HF7072



Overall Height: 12.94 (329)
End 1 OD: 3.12 (79)
End 2 OD: 3.11 (79)
End 2 ID: 1.67 (42)

HF30529 PALL HC9801FUT4H



Overall Height: 4.47 (114)
Overall OD: 1.98 (50)
End 1 ID: 0.93 (24)

HF30542 PALL HC9651FKP8H Not available in all parts of the world.



Overall Height: 8.18 (208)
Overall OD: 3.15 (80)
End 1 ID: 1.67 (42)

HF30543 PALL HC9651FKP16H



Overall Height: 16.91 (430)
Overall OD: 3.15 (80)
End 1 ID: 1.67 (42)

HF30544 PALL HC9651FUP8Z



Overall Height: 8.18 (208)
Overall OD: 3.15 (80)
End 1 ID: 1.67 (42)

HF30552 PALL HC8200FKP16H

Overall Height: 16.59 (421)
End 1 OD: 3.25 (83)
End 2 OD: 3.19 (81)
End 1 ID: 1.49 (38)

HF30559 PALL HC6400FKP16H



Overall Height: 16.81 (427)
End 1 OD: 3.41 (87)
End 2 OD: 3.39 (86)
End 1 ID: 1.95 (50)

HF30560 PALL HC6300FKP16H

Overall Height: 16.81 (427)
End 1 OD: 3.14 (80)
End 2 OD: 3.12 (79)
End 1 ID: 1.61 (41)

HF30566 PALL HC9021FUT8Z



Overall Height: 8.21 (209)
Overall OD: 1.79 (45)
End 1 ID: 0.99 (25)

HF30568 PALL HC8300FDP16H



Overall Height: 16.55 (420)
Overall OD: 5.94 (151)
End 1 ID: 4.11 (104)

HF30569 PALL HC8300FDP16Z

Overall Height: 16.55 (420)
Overall OD: 5.94 (151)
End 1 ID: 4.11 (104)

HF30572 PALL HC8800FKP16H Not available in all parts of the world.



Overall Height: 16.89 (429)
Overall OD: 3.39 (86)
End 1 ID: 1.93 (49)

HF30576 Replaces ST 3980SGHV08 Not available in all parts of the world.



Overall Height: 8.18 (208)
Overall OD: 1.98 (50)
End 1 ID: 0.93 (24)

HF30583 PALL HC9650FKP16Z
Upgrade of HF7492



Overall Height: 17.01 (432)
Overall OD: 3.10 (79)
End 1 ID: 1.67 (42)

HF30584 PALL HC9600FKP16H
Upgrade of HF7076



Overall Height: 16.86 (428)
End 1 OD: 3.12 (79)
End 2 OD: 3.11 (79)
End 2 ID: 1.67 (42)

HF30595 PALL HC9700FDP18H



Overall Height: 18.43 (468)
Overall OD: 3.91 (99)
End 1 ID: 1.61 (41)

HF30599 PALL HC9901FUP39Z



Overall Height: 39.07 (992)
Overall OD: 3.78 (96)
End 1 ID: 2.18 (55)

HF30613 PALL HC9801FUP4H

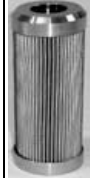

Overall Height: 4.47 (114)
Overall OD: 1.98 (50)
End 1 ID: 0.93 (24)

HF30614 PALL HC9801FKP8Z Not available in all parts of the world.

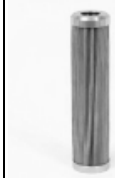

Overall Height: 8.18 (208)
Overall OD: 1.98 (50)
End 1 ID: 0.93 (24)

HF30618 PALL HC6400FKP26H



Overall Height: 25.81 (656)
End 1 OD: 3.41 (87)
End 2 OD: 3.39 (86)
End 1 ID: 1.95 (50)

HF30624 PALL HC9901FUT13H



Overall Height: 12.94 (329)
Overall OD: 3.78 (96)
End 1 ID: 2.18 (55)

HF30626 PALL HC9700FKP27H



Overall Height: 27.77 (705)
Overall OD: 3.91 (99)
End 1 ID: 1.61 (41)

HF30630 PALL HC9901FUT26Z



Overall Height: 26.01 (661)
Overall OD: 3.78 (96)
End 1 ID: 2.18 (55)

HF30631 PALL HC9901FDT39Z







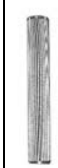





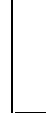



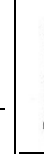

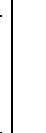





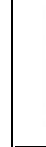

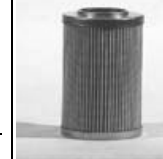
Overall Height: 39.07 (992)
Overall OD: 3.78 (96)
End 1 ID: 2.18 (55)

HF30634 PALL HC8300FKP39H
Upgrade of HF7008

























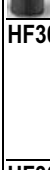

Overall Height: 38.37 (975)
Overall OD: 5.94 (151)
End 1 ID: 4.11 (104)

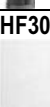
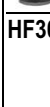

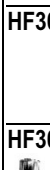
E. PRODUCT GUIDE

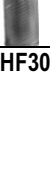



HF30635  PALL HC8300FKP39Z Overall Height: 38.37 (975) Overall OD: 5.94 (151) End 1 ID: 4.11 (104)	HF30685  PALL HC8400FKP16Z Overall Height: 16.85 (428) Overall OD: 5.99 (152) End 1 ID: 3.23 (82)	HF30710  PALL HC9800FDT4H Overall Height: 4.44 (113) Overall OD: 1.98 (50) End 1 ID: 0.92 (23)
HF30638  PALL HC9021FKP8Z Overall Height: 8.21 (209) Overall OD: 1.79 (45) End 1 ID: 0.99 (25)	HF30686  PALL HC8400FKP16H Overall Height: 16.85 (428) Overall OD: 5.99 (152) End 1 ID: 3.23 (82)	HF30711  PALL HC9800FUT4Z Overall Height: 4.44 (113) Overall OD: 1.98 (50) End 1 ID: 0.92 (23)
HF30642  PALL HC8900FKP39H Overall Height: 38.78 (985) Overall OD: 3.79 (96) End 1 ID: 2.18 (55)	HF30692  PALL HC8400FKP8Z, PALL HC8400FDP8Z Overall Height: 8.17 (208) Overall OD: 5.98 (152) End 1 ID: 3.23 (82)	HF30712  PALL HC8700FKT4H Overall Height: 4.73 (120) Overall OD: 2.06 (52) End 1 ID: 0.92 (23)
HF30650  PALL HC9651FUT8H Overall Height: 8.18 (208) Overall OD: 3.15 (80) End 1 ID: 1.67 (42)	HF30693  HYDAC 60D020BNHC Overall Height: 3.31 (84) End 1 OD: 1.88 (48) End 2 OD: 1.86 (47) End 2 ID: 0.87 (22)	HF30714  FAIREY ARLON 270L123A Overall Height: 4.06 (103) Overall OD: 2.87 (73) End 1 ID: 1.24 (32)
HF30651  Overall Height: 16.91 (430) Overall OD: 3.15 (80) End 1 ID: 1.67 (42)	HF30694  PUROLATOR 7511150, PTI 7511150 Overall Height: 3.47 (88) Overall OD: 1.63 (41) End 1 ID: 0.86 (22)	HF30724  FAIREY ARLON 370L223A Overall Height: 7.87 (200) Overall OD: 3.70 (94) End 1 ID: 1.88 (48)
HF30654  PALL HC6500FKP13H Overall Height: 12.93 (328) End 1 OD: 3.80 (97) End 2 OD: 3.79 (96) End 1 ID: 2.21 (56)	HF30697  PALL HC9600FKT4H Upgrade of HF7067 Overall Height: 4.60 (117) End 1 OD: 3.12 (79) End 2 OD: 3.11 (79) End 2 ID: 1.67 (42)	HF30725  PALL HC8300FKT8H Overall Height: 7.87 (200) Overall OD: 6.00 (152) End 1 ID: 4.11 (104)
HF30657  PALL HC6400FKP13H Overall Height: 12.93 (328) End 1 OD: 3.41 (87) End 2 OD: 3.39 (86) End 1 ID: 1.95 (50)	HF30700  FAIREY ARLON 370L123A Overall Height: 3.98 (101) Overall OD: 3.70 (94) End 1 ID: 1.88 (48)	HF30728  PALL HC9020FDT8H Gasket: 3913044 (1) Overall Height: 8.08 (205) End 1 OD: 1.78 (45) End 2 OD: 1.75 (44) End 2 ID: 0.98 (25)
HF30668  FAIREY ARLON 170L123A Overall Height: 2.60 (66) Overall OD: 2.17 (55) End 1 ID: 0.72 (18)	HF30702  HYDAC 160D020BNHC Overall Height: 4.53 (115) Overall OD: 2.74 (70) End 1 ID: 1.34 (34)	HF30730  PALL HC9800FUT8H, PALL HC9800FDT8H Overall Height: 8.21 (209) Overall OD: 1.98 (50) End 1 ID: 0.92 (23)
HF30679  NORDBERG 3894081, VULCAN 3894081 Overall Height: 31.20 (792) Overall OD: 6.31 (160) End 1 ID: 1.60 (41)	HF30707  PALL HC9020FDT4H Gasket: 3913044 (1) Overall Height: 4.47 (114) End 1 OD: 1.78 (45) End 2 OD: 1.75 (44) End 2 ID: 0.98 (25)	HF30731  PALL HC8500FDT8H Not available in all parts of the world. Overall Height: 8.06 (205) Overall OD: 3.78 (96) End 1 ID: 1.70 (43)



E. PRODUCT GUIDE

HF30733  PALL HC8700FKT8H Overall Height: 8.38 (213) Overall OD: 2.06 (52) End 1 ID: 0.92 (23)	HF30761  HYDAC 660D020BHHC Overall Height: 12.92 (328) Overall OD: 3.59 (91) End 1 ID: 1.89 (48)	HF30790  PALL HC6400FKT16H Overall Height: 16.81 (427) End 1 OD: 3.41 (87) End 2 OD: 3.39 (86) End 1 ID: 1.95 (50)
HF30742  PALL HC8200FKT8H Overall Height: 6.42 (163) End 1 OD: 3.25 (83) End 2 OD: 3.19 (81) End 1 ID: 1.49 (38)	HF30764  PALL HC8200FKT13H Overall Height: 12.88 (327) End 1 OD: 3.25 (83) End 2 OD: 3.19 (81) End 1 ID: 1.49 (38)	HF30791  PALL HC8300FKT16H, PALL HC8300FDT16H Overall Height: 16.86 (428) Overall OD: 5.98 (152) End 1 ID: 4.11 (104)
HF30745  PALL HC6400FKT8H Overall Height: 8.25 (210) End 1 OD: 3.41 (87) End 2 OD: 3.39 (86) End 1 ID: 1.95 (50)	HF30768  PALL HC9400FDT13H Overall Height: 13.12 (333) Overall OD: 3.79 (96) End 1 ID: 2.18 (55)	HF30795  PALL HC8800FKT16H Overall Height: 16.89 (429) Overall OD: 3.39 (86) End 1 ID: 1.93 (49)
HF30747  PALL HC6300FKT8H Overall Height: 8.21 (209) End 1 OD: 3.12 (79) End 2 OD: 3.11 (79) End 2 ID: 1.67 (42)	HF30771  PALL HC8900FKT13H, PARKER 929923Q, PALL HC8900FDT13H Overall Height: 12.96 (329) Overall OD: 3.79 (96) End 1 ID: 2.18 (55)	HF30797  PALL HC9600FKT16H Overall Height: 16.86 (428) End 1 OD: 3.12 (79) End 2 OD: 3.11 (79) End 2 ID: 1.67 (42)
HF30748  PALL HC9600FKT8Z, PALL HC9600FDT8Z Overall Height: 8.21 (209) End 1 OD: 3.12 (79) End 2 OD: 3.11 (79) End 2 ID: 1.67 (42)	HF30774  PALL HC8500FDT13H, PALL HC8500FKT13H Overall Height: 12.80 (325) Overall OD: 3.78 (96) End 1 ID: 1.67 (42)	HF30800  PALL HC9650FKT16Z Overall Height: 17.01 (432) Overall OD: 3.10 (79) End 1 ID: 1.67 (42)
HF30750  PALL HC9650FKT8Z Overall Height: 8.36 (212) Overall OD: 3.10 (79) End 1 ID: 1.67 (42)	HF30776  PALL HC9800FKT13H Overall Height: 12.99 (330) Overall OD: 1.98 (50) End 1 ID: 0.92 (23)	HF30805  PALL HC9700FKS27H, PALL HC9700FKT18H Overall Height: 18.43 (468) Overall OD: 3.91 (99) End 1 ID: 1.61 (41)
HF30754  PALL HC9700FDT9H, PALL HC9700FKT9H Overall Height: 9.22 (234) Overall OD: 3.91 (99) End 1 ID: 1.61 (41)	HF30779  PALL HC9600FKT13H, PALL HC9600FDT13H Overall Height: 12.95 (329) End 1 OD: 3.12 (79) End 2 OD: 3.11 (79) End 2 ID: 1.67 (42)	HF30819  PALL HC6400FKT26H Overall Height: 25.81 (656) End 1 OD: 3.41 (87) End 2 OD: 3.39 (86) End 1 ID: 1.95 (50)
HF30758  FAIREY ARLON 270L223A Overall Height: 9.29 (236) Overall OD: 2.89 (74) End 1 ID: 1.24 (32)	HF30786  PALL HC6500FKT16H Overall Height: 16.81 (427) End 1 OD: 3.80 (97) End 2 OD: 3.79 (96) End 1 ID: 2.21 (56)	HF30832  PALL HC8900FDT39H Overall Height: 38.78 (985) Overall OD: 3.79 (96) End 1 ID: 2.18 (55)
HF30760  FAIREY ARLON 370L323A Overall Height: 12.68 (322) Overall OD: 3.70 (94) End 1 ID: 1.88 (48)	HF30787  PALL HC6300FKT16H Overall Height: 16.81 (427) End 1 OD: 3.14 (80) End 2 OD: 3.12 (79) End 1 ID: 1.61 (41)	HF30833  PALL HC9400FDT39H Overall Height: 38.93 (989) Overall OD: 3.79 (96) End 1 ID: 2.18 (55)

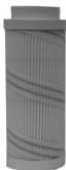











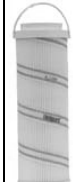









E. PRODUCT GUIDE

HF30837	FAIREY ARLON 170L223A		Overall Height: 4.80 (122) Overall OD: 2.17 (55) End 1 ID: 0.72 (18)
HF30843	PALL HC6400FKT13H		Overall Height: 12.93 (328) End 1 OD: 3.41 (87) End 2 OD: 3.39 (86) End 1 ID: 1.95 (50)
HF30845	PALL HC6300FKT13H		Overall Height: 12.93 (328) End 1 OD: 3.14 (80) End 2 OD: 3.12 (79) End 1 ID: 1.61 (41)
HF30847	PALL HC6500FKT13H		Overall Height: 12.93 (328) End 1 OD: 3.80 (97) End 2 OD: 3.79 (96) End 1 ID: 2.21 (56)
HF30850	PALL HC8400FDT8H		Overall Height: 8.17 (208) Overall OD: 5.98 (152) End 1 ID: 3.23 (82)
HF30866	PALL HC8304FKP16Z		Overall Height: 17.80 (452) End 1 OD: 5.73 (146) End 2 OD: 5.36 (136) End 1 ID: 3.77 (96) End 2 ID: 3.80 (97)
HF30867	PALL HC8304FKP39Z		Overall Height: 39.60 (1006) End 1 OD: 5.73 (146) End 2 OD: 5.36 (136) End 1 ID: 3.77 (96) End 2 ID: 3.80 (97)
HF30870	PALL HC8304FKN16Z		Overall Height: 17.80 (452) End 1 OD: 5.73 (146) End 2 OD: 5.36 (136) End 1 ID: 3.77 (96) End 2 ID: 3.80 (97)
HF30871	PALL HC8304FKN39Z		Overall Height: 39.60 (1006) End 1 OD: 5.73 (146) End 2 OD: 5.36 (136) End 1 ID: 3.77 (96) End 2 ID: 3.80 (97)
HF30874	PALL HC8304FKS16Z		Overall Height: 17.80 (452) End 1 OD: 5.73 (146) End 2 OD: 5.36 (136) End 1 ID: 3.77 (96) End 2 ID: 3.80 (97)





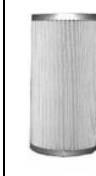





















HF30875	PALL HC8304FKS39Z		Overall Height: 39.60 (1006) End 1 OD: 5.73 (146) End 2 OD: 5.36 (136) End 1 ID: 3.77 (96) End 2 ID: 3.80 (97)
HF30878	PALL HC8304FKT16Z		Overall Height: 17.80 (452) End 1 OD: 5.73 (146) End 2 OD: 5.36 (136) End 1 ID: 3.77 (96) End 2 ID: 3.80 (97)
HF30879	PALL HC8304FKT39Z		Overall Height: 39.60 (1006) End 1 OD: 5.73 (146) End 2 OD: 5.36 (136) End 1 ID: 3.77 (96) End 2 ID: 3.80 (97)
HF30889	PALL HC8314FKN39H		Overall Height: 39.60 (1006) End 1 OD: 6.27 (159) End 2 OD: 5.91 (150) End 1 ID: 3.77 (96) End 2 ID: 3.80 (97)
HF30897	PARKER 934124Q, PALL HC9604FKT13H, PALL HC8904FKT16H		Overall Height: 39.60 (1006) End 1 OD: 6.27 (159) End 2 OD: 5.91 (150) End 1 ID: 3.77 (96) End 2 ID: 3.80 (97)
HF30904	PALL HC9604FKP13Z		Overall Height: 12.66 (321) Overall OD: 3.13 (80) End 1 ID: 1.94 (49)
HF30907	PALL HC9604FKN8Z		Overall Height: 7.92 (201) Overall OD: 3.13 (80) End 1 ID: 1.94 (49)
HF30908	PALL HC9604FKN13Z		Overall Height: 12.66 (322) Overall OD: 3.13 (80) End 1 ID: 1.94 (49)
HF30911	PALL HC9604FKS8Z		Overall Height: 7.92 (201) Overall OD: 3.13 (80) End 1 ID: 1.94 (49)
HF30912	PALL HC9604FKS13Z		Overall Height: 12.66 (322) Overall OD: 3.13 (80) End 1 ID: 1.94 (49)

HF30914	SEPARATION TECHNOLOGIES 3960ZGMB13		Overall Height: 12.66 (322) Overall OD: 3.13 (80) End 1 ID: 1.94 (49)
HF30915	PALL HC9604FKT8Z		Overall Height: 7.92 (201) Overall OD: 3.13 (80) End 1 ID: 1.94 (49)
HF30916	PALL HC9604FKT13Z		Overall Height: 12.66 (322) Overall OD: 3.13 (80) End 1 ID: 1.94 (49)
HF30918	PALL HC9604FKP16Z		Overall Height: 16.54 (420) Overall OD: 3.13 (80) End 1 ID: 1.94 (49)
HF30920	PALL HC9604FKN16Z		Overall Height: 16.54 (420) Overall OD: 3.13 (80) End 1 ID: 1.94 (49)
HF30921	KOMATSU AK3572		Overall Height: 16.54 (420) Overall OD: 3.13 (80) End 1 ID: 1.94 (49)
HF30922	PALL HC9604FKS16Z		Overall Height: 16.54 (420) Overall OD: 3.13 (80) End 1 ID: 1.94 (49)
HF30924	PALL HC9604FKT16Z		Overall Height: 16.54 (420) Overall OD: 3.13 (80) End 1 ID: 1.94 (49)
HF30947	PALL HC8904FKS16H		Overall Height: 16.30 (414) End 1 OD: 4.11 (104) End 2 OD: 3.83 (97) End 2 ID: 2.53 (64)
HF30948	PALL HC8904FKS26H		Overall Height: 25.16 (639) End 1 OD: 4.11 (104) End 2 OD: 3.83 (97) End 2 ID: 2.53 (64)
HF30949	PALL HC8904FKS39H		Overall Height: 38.16 (969) End 1 OD: 4.11 (104) End 2 OD: 3.83 (97) End 2 ID: 2.53 (64)
HF30952	PALL HC8904FKS16Z		Overall Height: 16.30 (414) End 1 OD: 4.11 (104) End 2 OD: 3.83 (97) End 2 ID: 2.53 (64)























E. PRODUCT GUIDE

<p>HF30957 Replaces ST 3890ZGMB16</p>  <p>Overall Height: 16.30 (414) End 1 OD: 4.11 (104) End 2 OD: 3.83 (97) End 2 ID: 2.53 (64)</p>	<p>HF35006 DONALDSON P169078, BALDWIN BT8416</p>  <p>Overall Height: 4.47 (114) Largest OD: 3.82 (97) Thread Size: 1 3/8</p>	<p>HF35016 Replaces ST 3940ZGEB12</p>  <p>Overall Height: 12.31 (313) End 1 OD: 4.12 (105) End 2 OD: 3.83 (97) End 1 ID: 2.53 (64) End 2 ID: 2.42 (61)</p>
<p>HF30959 PALL HC8904FKT39H</p> <p>Overall Height: 38.16 (969) End 1 OD: 4.11 (104) End 2 OD: 3.83 (97) End 2 ID: 2.53 (64)</p>	<p>HF35008 BALDWIN BT611MPG</p>  <p>Overall Height: 7.02 (178) Largest OD: 4.65 (118) Thread Size: 1 1/4-11 BSP</p>	<p>HF35018 CATERPILLAR 937520, CATERPILLAR 937521, CATERPILLAR 937521X</p>  <p>Overall Height: 6.99 (178) Largest OD: 3.69 (94) Thread Size: 1 1/8-16</p>
<p>HF30968 PALL HC9404FKP26H</p> <p>Overall Height: 25.68 (652) End 1 OD: 4.12 (105) End 2 OD: 3.83 (97) End 1 ID: 2.53 (64)</p>	<p>HF35009 BALDWIN BT606MPG</p>  <p>Overall Height: 5.62 (143) Largest OD: 3.66 (93) Thread Size: 31/32-20 UNS-2B</p>	<p>HF35019 WAUKESHA 153238, WAUKESHA 153290, WAUKESHA 161899</p>  <p>Overall Height: 16.38 (416) Overall OD: 4.25 (108)</p>
<p>HF30996 PALL HC9404FKT13H</p> <p>Overall Height: 12.95 (329) End 1 OD: 4.12 (105) End 2 OD: 3.83 (97) End 1 ID: 2.53 (64)</p>	<p>HF35010 CATERPILLAR 1328875</p>  <p>Overall Height: 9.32 (237) Overall OD: 3.94 (100) End 1 ID: 2.27 (58) End 2 ID: 2.27 (58)</p>	<p>HF35020 WHITE 303343111, WHITE 303343111B</p>  <p>Overall Height: 5.98 (152) Overall OD: 4.53 (115) End 1 ID: 1.84 (47)</p>
<p>HF35000 DONALDSON P174914</p>  <p>Overall Height: 18.78 (477) Overall OD: 3.68 (93) End 1 ID: 1.75 (44)</p>	<p>HF35012 CLARK 943559</p>  <p>Overall Height: 14.50 (368) Overall OD: 6.01 (153) End 1 ID: 3.50 (89) End 2 ID: 3.50 (89)</p>	<p>HF35021 Various Hydraulic Applications</p>  <p>Overall Height: 16.05 (408) End 1 OD: 4.38 (111) End 2 OD: 4.37 (111) End 1 ID: 0.73 (18) End 2 ID: 2.13 (54)</p>
<p>HF35002 DONALDSON P163435</p>  <p>Overall Height: 12.25 (311) Largest OD: 5.00 (127) Thread Size: 3</p>	<p>HF35013 DONALDSON P163439, INGERSOLL-RAND 35252154</p>  <p>Overall Height: 7.63 (194) Overall OD: 6.02 (153) End 1 ID: 1.72 (44) End 2 ID: 1.72 (44)</p>	<p>HF35022 JOHN DEERE AT78046</p>  <p>Overall Height: 16.05 (408) Overall OD: 4.38 (111) End 1 ID: 2.43 (62) End 2 ID: 0.73 (18)</p>
<p>HF35003 DONALDSON P162205</p>  <p>Overall Height: 8.81 (224) Largest OD: 5.00 (127) Thread Size: 3</p>	<p>HF35014 CLARK 943559</p>  <p>Overall Height: 14.50 (368) Overall OD: 6.01 (153) End 1 ID: 3.50 (89) End 2 ID: 3.50 (89)</p>	<p>HF35038 PALL HC0101FKN36H</p>  <p>Overall Height: 36.00 (914) Overall OD: 6.06 (154) End 1 ID: 2.63 (67)</p>
<p>HF35004 DONALDSON P176208, BALDWIN BT8875MPG</p>  <p>Overall Height: 7.60 (193) Largest OD: 4.77 (121) Thread Size: 1 3/4-12 UN-2B</p>	<p>HF35015 KOMATSU AK3570</p>  <p>Overall Height: 12.31 (313) End 1 OD: 4.12 (105) End 2 OD: 3.83 (97) End 1 ID: 2.53 (64) End 2 ID: 2.42 (61)</p>	<p>HF35052 LENZ 815</p>  <p>Overall Height: 7.75 (197) Overall OD: 4.00 (102) End 1 ID: 2.03 (52)</p>
<p>HF35005 DONALDSON P550083</p>  <p>Overall Height: 11.50 (292) Overall OD: 4.41 (112) End 1 ID: 2.76 (70)</p>		



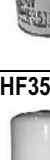

















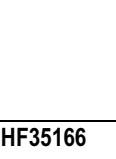

E. PRODUCT GUIDE

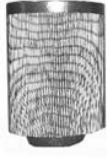
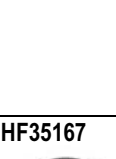
HF35074  VOLVO 15215270 Gear box applications Overall Height: 5.83 (148) Overall OD: 2.56 (65) End 1 ID: 1.22 (31)	HF35108  NEW HOLLAND 86900135 Overall Height: 3.84 (98) Largest OD: 3.73 (95) Thread Size: 1-12 UNF-2B	HF35117  FAIREY ARLON TXW3GDL20 Overall Height: 5.91 (150) Overall OD: 2.84 (72) End 1 ID: 0.28 (7) End 2 ID: 1.77 (45)
HF35076  MANN & HUMMEL WD13145 Overall Height: 11.89 (302) Largest OD: 5.51 (140) BPV Setting: 36.26 (250) Thread Size: 1 1/2-16UNF-2B	HF35109  LIEBHERR 7373878 Overall Height: 20.47 (520) End 1 OD: 6.12 (156) End 2 OD: 5.98 (152) End 1 ID: 3.94 (100) End 2 ID: 3.16 (80)	HF35118  FAIREY ARLON TXW3BGDL10 Overall Height: 5.51 (140) Overall OD: 4.17 (106) End 1 ID: 0.35 (9) End 2 ID: 2.84 (72)
HF35077  LINDE 9830613 Overall Height: 5.51 (140) Largest OD: 3.15 (80) BPV Setting: 50.76 (350) Thread Size: 3/4-16 UNF-1B	HF35110  FAIREY ARLON TXX10 Overall Height: 2.24 (57) Overall OD: 2.84 (72) End 1 ID: 0.28 (7) End 2 ID: 1.77 (45)	HF35119  FAIREY ARLON TXW3DGDL10 Overall Height: 7.87 (200) Overall OD: 2.84 (72) End 1 ID: 0.28 (7) End 2 ID: 1.77 (45)
HF35081  JOY 15626732 Overall Height: 6.72 (171) Largest OD: 5.08 (129) Thread Size: 1 1/2-16 UN-2B	HF35111  FAIREY ARLON TXX210 Overall Height: 4.17 (106) Overall OD: 2.84 (72) End 1 ID: 0.28 (7) End 2 ID: 1.77 (45)	HF35120  FAIREY ARLON TXW3DGDL20 Overall Height: 7.87 (200) Overall OD: 2.84 (72) End 1 ID: 0.28 (7) End 2 ID: 1.77 (45)
HF35082  MP FILTRI CS150P10A Overall Height: 8.92 (227) Largest OD: 5.04 (128) Thread Size: 1 1/4 BSP	HF35112  FAIREY ARLON TXX3B10 Overall Height: 5.51 (140) Overall OD: 4.17 (106) End 1 ID: 0.35 (9) End 2 ID: 2.84 (72)	HF35121  FAIREY ARLON TXW3ERGDL10 Overall Height: 11.81 (300) Overall OD: 2.84 (72) End 1 ID: 0.28 (7) End 2 ID: 1.77 (45)
HF35098  DYNAPAC 903247 Overall Height: 9.09 (231) Overall OD: 2.52 (64) End 1 ID: 1.06 (27)	HF35113  FAIREY ARLON TXX3ER10 Overall Height: 11.81 (300) Overall OD: 2.84 (72) End 1 ID: 0.28 (7) End 2 ID: 1.77 (45)	HF35122  FAIREY ARLON TXW3ERGDL20 Overall Height: 11.81 (300) Overall OD: 2.84 (72) End 1 ID: 0.28 (7) End 2 ID: 1.77 (45)
HF35099  ZINGA BE1018 Overall Height: 3.49 (89) Largest OD: 3.05 (77) ADBV: Yes BPV Setting: 17.50 (121) Thread Size: 3/4-16 UNF-2B	HF35114  FAIREY ARLON TXX7A10 Overall Height: 9.84 (250) Overall OD: 4.96 (126) End 1 ID: 0.35 (9) End 2 ID: 3.62 (92)	HF35123  FAIREY ARLON TXW5GDL3 Overall Height: 10.24 (260) Overall OD: 4.17 (106) End 1 ID: 0.35 (9) End 2 ID: 2.84 (72)
HF35101  CATERPILLAR 1328876 Overall Height: 9.12 (232) Overall OD: 5.10 (130) End 1 ID: 3.35 (85)	HF35115  FAIREY ARLON TXWGD10 Overall Height: 2.24 (57) Overall OD: 2.84 (72) End 1 ID: 0.28 (7) End 2 ID: 1.77 (45)	HF35124  FAIREY ARLON TXW5GDL6 Overall Height: 10.24 (260) Overall OD: 4.17 (106) End 1 ID: 0.35 (9) End 2 ID: 2.84 (72)
HF35102  MP FILTRI CS50P25A Overall Height: 5.60 (142) Largest OD: 3.68 (94) Thread Size: 3/4-14 BSP	HF35116  FAIREY ARLON TXW2GDL10 Overall Height: 4.17 (106) Overall OD: 2.84 (72) End 1 ID: 0.28 (7) End 2 ID: 1.77 (45)	HF35125  FAIREY ARLON TXW5GDL20 Overall Height: 10.24 (260) Overall OD: 4.17 (106) End 1 ID: 0.35 (9) End 2 ID: 2.84 (72)

























E. PRODUCT GUIDE

<p>HF35126 FAIREY ARLON TXW5AGDL6</p>  <p>Overall Height: 18.31 (465) Overall OD: 4.17 (106) End 1 ID: 0.35 (9) End 2 ID: 2.84 (72)</p>	<p>HF35134 FAIREY ARLON TXW14GDL10</p>  <p>Overall Height: 42.91 (1090) Overall OD: 7.99 (203) End 1 ID: 0.51 (13) End 2 ID: 6.18 (157)</p>	<p>HF35142 FAIREY ARLON FXX310</p>  <p>Overall Height: 11.40 (290) Overall OD: 4.96 (126) End 1 ID: 3.62 (92)</p>
<p>HF35127 FAIREY ARLON TXW5ARGDL20</p>  <p>Overall Height: 18.31 (465) Overall OD: 4.17 (106) End 1 ID: 0.35 (9) End 2 ID: 2.84 (72)</p>	<p>HF35135 FAIREY ARLON CXX310</p>  <p>Overall Height: 7.60 (193) Largest OD: 3.94 (100) Thread Size: M60X1.5</p>	<p>HF35143 FAIREY ARLON MXW2GDL20</p>  <p>Overall Height: 9.76 (248) End 1 OD: 2.64 (67) End 2 OD: 2.36 (60) End 1 ID: 1.06 (27) End 2 ID: 1.08 (28)</p>
<p>HF35128 FAIREY ARLON TXW8AGDL6</p>  <p>Overall Height: 11.42 (290) Overall OD: 4.96 (126) End 1 ID: 0.35 (9) End 2 ID: 3.62 (92)</p>	<p>HF35136 FAIREY ARLON MXW1GDL20</p>  <p>Overall Height: 4.84 (123) End 1 OD: 2.64 (67) End 2 OD: 2.36 (60) End 1 ID: 1.06 (27)</p>	<p>HF35150 CASE 254686A2 Case Loaders 570, 580, 590 series</p>  <p>Overall Height: 5.97 (152) Largest OD: 3.82 (97) Thread Size: 13/16 - 16 UN - 28</p>
<p>HF35129 FAIREY ARLON TXW8DGDL20</p>  <p>Overall Height: 22.84 (580) Overall OD: 4.96 (126) End 1 ID: 0.35 (9) End 2 ID: 3.62 (92)</p>	<p>HF35137 FAIREY ARLON MXW2GDL10</p>  <p>Overall Height: 9.76 (248) End 1 OD: 2.64 (67) End 2 OD: 2.36 (60) End 1 ID: 1.06 (27) End 2 ID: 1.08 (28)</p>	<p>HF35152 ALLISON 29501202, MOHAWK MFG. 29501202</p>  <p>Overall Height: 4.20 (107) Overall OD: 3.20 (81) End 1 ID: 1.50 (38)</p>
<p>HF35130 FAIREY ARLON TXW8DGDL10</p>  <p>Overall Height: 22.84 (580) Overall OD: 4.96 (126) End 1 ID: 0.35 (9) End 2 ID: 3.62 (92)</p>	<p>HF35138 CASE 87404834 Case 8830, 8840, 8850 SP Windrowers</p>  <p>Overall Height: 5.45 (138) Largest OD: 3.69 (94) Thread Size: 13/16-16 UNS-2B</p>	<p>HF35153 ALLISON 29526899 Kit contains two HF35152 plus gasket kit.</p>  <p>Overall Height: 4.20 (107) Overall OD: 3.00 (76) End 1 ID: 1.53 (39) End 2 ID: 1.65 (42)</p>
<p>HF35131 FAIREY ARLON TXW8EGDL20</p>  <p>Overall Height: 34.25 (870) Overall OD: 4.96 (126) End 1 ID: 0.35 (9) End 2 ID: 3.62 (92)</p>	<p>HF35139 J.C.B. 58118063</p>  <p>Overall Height: 3.64 (93) Largest OD: 3.68 (94) ADBV: Yes BPV Setting: 17.40 (120) Thread Size: 1-12 UNF-2B</p>	<p>HF35156 LETOURNEAU-WESTINGHOUSE 4172125 Letourneau L1000 series loaders</p>  <p>Overall Height: 44.12 (1121) Overall OD: 7.44 (189) End 1 ID: 4.85 (123)</p>
<p>HF35132 FAIREY ARLON TXW13RGDL3</p>  <p>Overall Height: 32.48 (825) Overall OD: 7.99 (203) End 1 ID: 0.51 (13) End 2 ID: 6.18 (157)</p>	<p>HF35140 ZF 750131061</p>  <p>Overall Height: 8.29 (210) Largest OD: 3.72 (94) Thread Size: M24 X 1.5-6H EXT</p>	<p>HF35159 UCC HYDRAULICS UCSE1320</p>  <p>Overall Height: 4.37 (111) End 1 OD: 2.52 (64) End 2 OD: 2.34 (60) Thread Size: 3/4 BSP INT</p>
<p>HF35133 FAIREY ARLON TXW13RGDL20</p>  <p>Overall Height: 32.48 (825) Overall OD: 7.99 (203) End 1 ID: 0.51 (13) End 2 ID: 6.18 (157)</p>	<p>HF35141 FAIREY ARLON FTXW10RGDL10</p>  <p>Overall Height: 12.68 (322) Overall OD: 7.87 (200) End 1 ID: 5.89 (150)</p>	<p>HF35160 UCC HYDRAULICS UCSE1323</p>  <p>Overall Height: 5.51 (140) End 1 OD: 3.39 (86) End 2 OD: 3.29 (84) Thread Size: 1 1/2 BSP</p>









E. PRODUCT GUIDE

HF35161  UCC HYDRAULICS UCSE1324 Overall Height: 7.87 (200) End 1 OD: 3.39 (86) End 2 OD: 3.29 (84) Thread Size: 1 1/2 BSP	HF35169  UCC HYDRAULICS UCSE5103 Overall Height: 5.79 (147) BPV Setting: 3.63 (25) End 1 OD: 3.39 (86) End 2 OD: 3.33 (85) Thread Size: 1 1/2 BSP	HF35182  PALL HC8300FKP8Z Overall Height: 8.21 (209) Overall OD: 5.95 (151) End 1 ID: 4.11 (104)
HF35162  UCC HYDRAULICS UCSE1326 Overall Height: 10.24 (260) End 1 OD: 3.39 (86) End 2 OD: 3.29 (84) Thread Size: 2 BSP	HF35170  UCC HYDRAULICS UCSE5104 Overall Height: 8.11 (206) BPV Setting: 3.63 (25) End 1 OD: 3.39 (86) End 2 OD: 3.33 (85) Thread Size: 1 1/2 BSP	HF35183  PALL HC8300FKN8H Overall Height: 8.21 (209) Overall OD: 5.95 (151) End 1 ID: 4.11 (104)
HF35163  UCC HYDRAULICS UCSE1219 Overall Height: 5.91 (150) End 1 OD: 5.87 (149) End 2 OD: 5.91 (150) Thread Size: 2 BSP	HF35171  UCC HYDRAULICS UCSE5105 Overall Height: 10.53 (268) BPV Setting: 3.63 (25) End 1 OD: 3.39 (86) End 2 OD: 3.27 (83) Thread Size: 2 BSP	HF35184  AIR REFINER ARH0883LV05 Overall Height: 8.21 (209) Overall OD: 5.95 (151) End 1 ID: 4.11 (104)
HF35164  UCC HYDRAULICS UCSE1220 Overall Height: 8.47 (215) End 1 OD: 5.87 (149) End 2 OD: 5.91 (150) Thread Size: 2 1/2 BSP	HF35172  UCC HYDRAULICS UCSE5106 Overall Height: 6.20 (158) BPV Setting: 3.63 (25) End 1 OD: 5.87 (149) End 2 OD: 5.91 (150) Thread Size: 2 BSP	HF35185  PALL HC8300FKS8Z Overall Height: 8.21 (209) Overall OD: 5.95 (151) End 1 ID: 4.11 (104)
HF35165  UCC HYDRAULICS UCSE1221 Overall Height: 10.55 (268) End 1 OD: 5.87 (149) End 2 OD: 5.91 (150) Thread Size: 3 BSP	HF35173  UCC HYDRAULICS UCSE5107 Overall Height: 8.64 (220) BPV Setting: 3.63 (25) End 1 OD: 5.87 (149) End 2 OD: 5.91 (150) Thread Size: 2 1/2 BSP	HF35186  PALL HC8300FKS8H Overall Height: 8.21 (209) Overall OD: 5.95 (151) End 1 ID: 4.11 (104)
HF35166  UCC HYDRAULICS UCSE5100 Overall Height: 4.29 (109) Overall OD: 1.73 (44) BPV Setting: 3.63 (25) Thread Size: 1/2 BSP	HF35174  UCC HYDRAULICS UCSE5108 Overall Height: 10.85 (276) BPV Setting: 3.63 (25) End 1 OD: 5.87 (149) End 2 OD: 5.91 (150) Thread Size: 3 BSP	HF35194  ARGO P3061352 Overall Height: 5.10 (130) Overall OD: 2.32 (59) BPV Setting: 21.75 (150) End 1 ID: 1.04 (26) End 2 ID: 0.59 (15)
HF35167  UCC HYDRAULICS UCSE5101 Overall Height: 4.57 (116) BPV Setting: 3.63 (25) End 1 OD: 2.54 (65) End 2 OD: 2.36 (60) Thread Size: 3/4 BSP	HF35180  MERCEDES-BENZ 3072700398 Overall Height: 1.24 (32) BPV Setting: 43.51 (300) End 1 OD: 8.03 (204) End 2 OD: 7.64 (194)	HF35195  CATERPILLAR 1262081 Overall Height: 16.73 (425) Overall OD: 5.59 (142) End 1 ID: 3.84 (98)
HF35168  UCC HYDRAULICS UCSE5102 Overall Height: 5.75 (146) BPV Setting: 3.63 (25) End 1 OD: 2.54 (65) End 2 OD: 2.36 (60) Thread Size: 1 BSP	HF35181  PALL HC8300FKP8H Overall Height: 8.21 (209) Overall OD: 5.95 (151) End 1 ID: 4.11 (104)	HF35197  LENZ CP103210 Overall Height: 10.39 (264) Largest OD: 4.24 (108) Thread Size: 1 1/8-16 UN-2B

E. PRODUCT GUIDE

HF35198  TIMBERJACK F058437 Overall Height: 5.00 (127) Overall OD: 2.76 (70) End 1 ID: 1.28 (32)	HF35206  MP FILTRI MF1002M60NB Overall Height: 5.34 (136) Overall OD: 2.76 (70) BPV Setting: 25.38 (175) End 1 ID: 1.07 (27) End 2 ID: 1.02 (26)	HF35214  MP FILTRI MF4002A10HB Overall Height: 8.41 (214) Overall OD: 5.12 (130) BPV Setting: 25.38 (175) End 1 ID: 2.46 (63) End 2 ID: 2.60 (66)
HF35199  MP FILTRI MF0301P10NB Overall Height: 4.37 (111) Overall OD: 2.05 (52) BPV Setting: 23.21 (160) End 2 ID: 1.02 (26)	HF35207  MP FILTRI MF1003P25NB Overall Height: 8.56 (218) Overall OD: 2.76 (70) BPV Setting: 25.38 (175) End 1 ID: 1.54 (39) End 2 ID: 1.02 (26)	HF35215  MP FILTRI MF4002A25HB Overall Height: 8.41 (214) Overall OD: 5.12 (130) BPV Setting: 25.38 (175) End 1 ID: 2.46 (63) End 2 ID: 2.60 (66)
HF35200  MP FILTRI MF0301P25NB Overall Height: 4.37 (111) Overall OD: 2.05 (52) BPV Setting: 23.21 (160) End 2 ID: 1.02 (26)	HF35208  MP FILTRI MF1003M60NB Overall Height: 8.56 (218) Overall OD: 2.76 (70) BPV Setting: 25.38 (175) End 1 ID: 1.54 (39) End 2 ID: 1.02 (26)	HF35216  MP FILTRI MF4002P25NB Overall Height: 8.41 (214) Overall OD: 5.12 (130) BPV Setting: 25.38 (175) End 1 ID: 2.46 (63) End 2 ID: 2.60 (66)
HF35201  MP FILTRI MF1001P10NB Overall Height: 3.52 (90) Overall OD: 2.76 (70) BPV Setting: 25.38 (175) End 1 ID: 1.07 (27)	HF35209  MP FILTRI MF1801P10NB Overall Height: 8.43 (214) Overall OD: 3.90 (99) BPV Setting: 25.38 (175) End 1 ID: 1.54 (39) End 2 ID: 1.30 (33)	HF35217  MP FILTRI MF4002M60NB Overall Height: 8.41 (214) Overall OD: 5.12 (130) BPV Setting: 25.38 (175) End 1 ID: 2.46 (63) End 2 ID: 2.60 (66)
HF35202  MP FILTRI MF1001P25NB Overall Height: 3.52 (90) Overall OD: 2.76 (70) BPV Setting: 25.38 (175) End 1 ID: 1.07 (27)	HF35210  MP FILTRI MF1801P25NB Overall Height: 8.43 (214) Overall OD: 3.90 (99) BPV Setting: 25.38 (175) End 1 ID: 1.54 (39) End 2 ID: 1.30 (33)	HF35218  MP FILTRI MF4003P25NB Overall Height: 10.00 (254) Overall OD: 5.12 (130) BPV Setting: 25.38 (175) End 1 ID: 2.46 (63) End 2 ID: 2.60 (66)
HF35203  MP FILTRI MF1002A10HB Overall Height: 5.34 (136) Overall OD: 2.76 (70) BPV Setting: 25.38 (175) End 1 ID: 1.07 (27) End 2 ID: 1.02 (26)	HF35211  MP FILTRI MF1801M60NB Overall Height: 8.43 (214) Overall OD: 3.90 (99) BPV Setting: 25.38 (175) End 1 ID: 1.54 (39) End 2 ID: 1.30 (33)	HF35219  MP FILTRI MF7501P10NB Overall Height: 16.22 (412) Overall OD: 5.12 (130) BPV Setting: 25.38 (175) End 1 ID: 2.46 (63) End 2 ID: 2.60 (66)
HF35204  MP FILTRI MF1002A25HB Overall Height: 5.34 (136) Overall OD: 2.76 (70) BPV Setting: 25.38 (175) End 1 ID: 1.07 (27) End 2 ID: 1.02 (26)	HF35212  MP FILTRI MF4001P25NB Overall Height: 5.98 (152) Overall OD: 5.12 (130) BPV Setting: 25.38 (175) End 1 ID: 1.95 (50) End 2 ID: 2.60 (66)	HF35220  MP FILTRI MF7501A25HB Overall Height: 16.22 (412) Overall OD: 5.12 (130) BPV Setting: 25.38 (175) End 1 ID: 2.46 (63) End 2 ID: 2.60 (66)
HF35205  MP FILTRI MF1002P25NB Overall Height: 5.34 (136) Overall OD: 2.76 (70) BPV Setting: 25.38 (175) End 1 ID: 1.07 (27) End 2 ID: 1.02 (26)	HF35213  MP FILTRI MF4001M60NB Replaces HF28871 Overall Height: 5.98 (152) Overall OD: 5.12 (130) BPV Setting: 25.38 (175) End 1 ID: 1.95 (50) End 2 ID: 2.60 (66)	HF35221  LIEBHERR 510670108 Overall Height: 8.35 (212) Overall OD: 5.12 (130) BPV Setting: 25.38 (175) End 1 ID: 1.95 (50) End 2 ID: 2.60 (66)

E. PRODUCT GUIDE

<p>HF35222 HITACHI 1930810</p>  <p>Overall Height: 10.00 (254) Overall OD: 5.12 (130) BPV Setting: 25.38 (175) End 1 ID: 2.46 (63) End 2 ID: 2.60 (66)</p>	<p>HF35258 CASE 1328276C1</p>  <p>Overall Height: 4.65 (118) Overall OD: 2.22 (57) End 1 ID: 0.95 (24)</p>	<p>HF35266 ARGO P2092022</p>  <p>Overall Height: 7.78 (198) Overall OD: 3.27 (83) End 1 ID: 1.59 (41)</p>
<p>HF35223 AGCO 3607790M1</p>  <p>Overall Height: 5.74 (146) Largest OD: 4.24 (108) Thread Size: 1 1/4 - 12 UNS 2B</p>	<p>HF35259 ARGO P3052000</p>  <p>Overall Height: 7.84 (199) Overall OD: 1.77 (45) End 1 ID: 0.75 (19) End 2 ID: 0.81 (21)</p>	<p>HF35267 ARGO P3051051</p>  <p>Overall Height: 4.09 (104) Overall OD: 1.77 (45) BPV Setting: 21.75 (150) End 1 ID: 0.75 (19) End 2 ID: 0.59 (15)</p>
<p>HF35235 RT Crane manufactured by International Transmission</p>  <p>Overall Height: 3.84 (98) Largest OD: 3.73 (95) ADBv: Yes BPV Setting: 4.80 (33) Thread Size: 1-12 UNF-2B</p>	<p>HF35260 ARGO P3051000</p>  <p>Overall Height: 4.09 (104) Overall OD: 1.77 (45) End 1 ID: 0.75 (19) End 2 ID: 0.81 (21)</p>	<p>HF35268 ARGO P3051002</p>  <p>Overall Height: 4.09 (104) Overall OD: 1.77 (45) End 1 ID: 0.75 (19) End 2 ID: 0.81 (21)</p>
<p>HF35237 HAMM 383279</p>  <p>Overall Height: 2.70 (69) Overall OD: 2.17 (55) End 1 ID: 1.04 (27) End 2 ID: 1.18 (30)</p>	<p>HF35261 ARGO P3072000</p>  <p>Overall Height: 7.82 (199) Overall OD: 2.76 (70) End 1 ID: 1.01 (26) End 2 ID: 0.79 (20)</p>	<p>HF35269 ARGO P3051011</p>  <p>Overall Height: 4.09 (104) Overall OD: 1.77 (45) End 1 ID: 0.75 (19) End 2 ID: 0.81 (21)</p>
<p>HF35238 ARGO S2060805</p>  <p>Overall Height: 2.89 (74) Overall OD: 2.32 (59) End 1 ID: 1.12 (29)</p>	<p>HF35262 ARGO P2072301</p>  <p>Overall Height: 8.98 (228) Overall OD: 2.52 (64) End 1 ID: 1.10 (28)</p>	<p>HF35270 ARGO P3051052</p>  <p>Overall Height: 4.09 (104) Overall OD: 1.77 (45) BPV Setting: 21.75 (150) End 1 ID: 0.75 (19) End 2 ID: 0.59 (15)</p>
<p>HF35252 ARGO V2121708</p>  <p>Overall Height: 6.58 (167) Overall OD: 4.65 (118) End 1 ID: 2.32 (59)</p>	<p>HF35263 ARGO P3062052</p>  <p>Overall Height: 7.84 (199) Overall OD: 2.32 (59) BPV Setting: 25.38 (175) End 1 ID: 1.06 (27) End 2 ID: 0.59 (15)</p>	<p>HF35271 ARGO V2121736</p>  <p>Overall Height: 6.58 (167) Overall OD: 4.65 (118) End 1 ID: 2.32 (59)</p>
<p>HF35254 NEW HOLLAND 87300195, CASE SBA340500890, IHC 87300196 New Holland Compact Tractor Applications with the Shibaura ISM engine</p>  <p>Overall Height: 4.02 (102) Largest OD: 3.36 (85) Thread Size: 3/4-16 UNF-2B</p>	<p>HF35264 ARGO P2061302</p>  <p>Overall Height: 5.26 (134) Overall OD: 2.36 (60) End 1 ID: 1.12 (29)</p>	<p>HF35272 ARGO P2112311</p>  <p>Overall Height: 8.96 (228) Overall OD: 4.33 (110) End 1 ID: 1.79 (46)</p>
<p>HF35255 KOMATSU 4241611140</p>  <p>Overall Height: 8.98 (228) Overall OD: 4.03 (102) End 1 ID: 1.77 (45)</p>	<p>HF35265 ARGO P2092011</p>  <p>Overall Height: 7.78 (198) Overall OD: 3.27 (83) End 1 ID: 1.59 (41)</p>	<p>HF35273 ARGO S2092000</p>  <p>Overall Height: 7.70 (196) Overall OD: 3.27 (83) End 1 ID: 2.32 (59)</p>
<p>HF35256 KHD(KLOCKNER-HUMBOLDT-DEUTZ) 4411047</p>  <p>Overall Height: 6.97 (177) Largest OD: 5.49 (140) BPV Setting: 2.90 (20) Thread Size: 1 1/2 16UNF 2B INT</p>		

E. PRODUCT GUIDE

HF35274 CASE 87300044, NEW HOLLAND 87300043 Case and New Holland Compact Tractor Applications

Overall Height: 7.02 (178)
Largest OD: 3.73 (95)
Thread Size: 1 1/8-16 UNF-2B



HF35276 TOYOTA 675022300071

Overall Height: 5.44 (138)
Largest OD: 4.25 (108)
Thread Size: 3/4-14 UNS-2B



HF35277 DONALDSON P160116, DONALDSON P160470

Overall Height: 16.00 (406)
Overall OD: 4.39 (112)
End 1 ID: 2.44 (62)



HF35278 DONALDSON P160108

Overall Height: 8.00 (203)
Overall OD: 4.39 (112)
End 1 ID: 2.44 (62)



HF35279 DONALDSON P160216

Overall Height: 16.00 (406)
Overall OD: 4.39 (112)
End 1 ID: 2.44 (62)



HF35280 DONALDSON P160605

Overall Height: 5.00 (127)
Overall OD: 4.39 (112)
End 1 ID: 2.44 (62)



HF35281 DONALDSON P160508

Overall Height: 8.00 (203)
Overall OD: 4.39 (112)
End 1 ID: 2.44 (62)



HF35283 DONALDSON P163859

Overall Height: 5.00 (127)
Overall OD: 4.39 (112)
End 1 ID: 2.44 (62)



HF35284 DONALDSON P165248

Overall Height: 8.00 (203)
Overall OD: 4.38 (111)
End 1 ID: 2.44 (62)



HF35286 DONALDSON P166246

Overall Height: 16.00 (406)
Overall OD: 4.38 (111)
End 1 ID: 2.44 (62)



HF35287 DONALDSON P165249

Overall Height: 16.00 (406)
Overall OD: 4.38 (111)
End 1 ID: 2.44 (62)



HF35288 CASE S111605

Overall Height: 13.00 (330)
Overall OD: 4.39 (112)
End 1 ID: 2.44 (62)



HF35289 WABCO 4068355, CLARK 2509282

Overall Height: 22.00 (559)
Overall OD: 7.44 (189)
End 1 ID: 4.85 (123)



HF35290 DONALDSON P164707

Overall Height: 22.00 (559)
Overall OD: 7.44 (189)
End 1 ID: 4.85 (123)



HF35291 DONALDSON P161365

Overall Height: 18.00 (457)
Overall OD: 6.00 (152)
End 1 ID: 3.41 (87)



HF35292 DONALDSON P161961

Overall Height: 18.00 (457)
Overall OD: 6.00 (152)
End 1 ID: 3.41 (87)



HF35293 JOHN DEERE AT312946

Overall Height: 4.42 (112)
End 1 OD: 5.10 (129)
End 2 OD: 5.10 (129)
End 1 ID: 2.85 (72)



HF35294 HAULOTTE 2427002910

Overall Height: 6.71 (171)
Overall OD: 2.22 (57)
End 1 ID: 0.96 (24)



HF35295 MC CORMICK 3224623R1

Overall Height: 2.82 (72)
Overall OD: 2.21 (56)
BPV Setting: 94.27 (650)
End 1 ID: 0.97 (25)



HF35296 ALLISON 29539579 For use on Allison automatic transmissions model A2400 used in 4300 International Trucks.

Overall Height: 2.97 (75)
Largest OD: 3.02 (77)
BPV Setting: 8.00 (55)
Thread Size: 3/4-20 UNEF-2B



HF35297 PARKER GO1315

Overall Height: 9.67 (246)
Overall OD: 2.36 (60)
End 1 ID: 0.98 (25)



HF35299 NEW HOLLAND 9842392

Overall Height: 7.90 (201)
Largest OD: 3.72 (94)
Thread Size: 1 3/8-12 UNF-2B



HF35300 ARGO S2121700

Overall Height: 6.58 (167)
Overall OD: 4.65 (118)
End 1 ID: 2.32 (59)
End 2 ID: 2.32 (59)



HF35301 ARGO K3134062

Overall Height: 18.05 (459)
Overall OD: 5.12 (130)
BPV Setting: 5.08 (35)
End 1 ID: 3.37 (86)

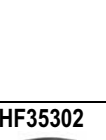

HF35302 MP FILTRI MF4003A10HB

Overall Height: 10.00 (254)
Overall OD: 5.12 (130)
BPV Setting: 25.38 (175)
End 1 ID: 2.46 (63)
End 2 ID: 2.60 (66)



HF35303 MP FILTRI MF4003A25HB

























Overall Height: 10.00
End 1 ID: 2.461
End 2 OD: 5.118



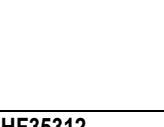

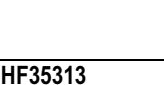





HF35304 PARKER GO4679







Overall Height: 7.97 (203)
Overall OD: 3.68 (94)
End 1 ID: 1.88 (48)

E. PRODUCT GUIDE

HF35305  CATERPILLAR 6E6408 Overall Height: 11.63 (295) Largest OD: 4.60 (117) Thread Size: 1 3/8-12 UNF-2B	HF35314  RENAULT AGRICULTURE 7700060361 Overall Height: 7.087 (180) Overall OD: 3.150 (80)	HF35324  MP FILTRI HP0371P10AN Overall Height: 3.62 (92) End 1 OD: 1.71 (44) End 2 OD: 1.65 (42) End 1 ID: 0.83 (21)
HF35306  RENAULT D.M.A. 6005007631 Overall Height: 5.61 (142.5) Overall OD: 3.15 (80.0)	HF35315  ATLAS COPCO 1202804000 Overall Height: 8.29 (211) Largest OD: 3.68 (94) BPV Setting: 36.26 (250) Thread Size: M20 X 1.5-6H INT	HF35325  PARKER GO4316 Overall Height: 9.764 End 1 ID: 1.004 End 2 OD: 2.638
HF35307  RENAULT AGRICULTURE 7701028138 Overall Height: 5.61 (142.5) Overall OD: 3.15 (80.0)	HF35316  ARGO V3082318 Overall Height: 9.15 (233) Overall OD: 3.07 (78) End 1 ID: 1.54 (39)	HF35326  LIEBHERR 7363107 Overall Height: 3.35 (85) End 1 OD: 1.85 (47) End 2 OD: 1.77 (45) End 1 ID: 0.83 (21)
HF35308  KUBOTA 6602136060 Overall Height: 4.02 (102) Largest OD: 3.31 (84) ADBV: Yes Thread Size: 3/4-16 UNF-2B	HF35317  CLAAS 7665380 Overall Height: 2.95 (75) Overall OD: 2.74 (70) End 1 ID: 0.53 (14) End 2 ID: 1.06 (27)	HF35327  MASSEY-FERGUSON 3615949M2 Overall Height: 8.19 (208) Overall OD: 1.99 (51) End 1 ID: 0.92 (23)
HF35309  FENDT F285102050010 Overall Height: 3.56 (91) Overall OD: 6.22 (158) BPV Setting: 5.80 (40) End 1 ID: 2.52 (64)	HF35318  CLAAS 8248360 Overall Height: 2.95 (75) Overall OD: 2.74 (70) End 1 ID: 0.53 (14) End 2 ID: 1.06 (27)	HF35328  ARGO V5124006 Overall Height: 15.79 (401) End 1 OD: 4.65 (118) End 2 OD: 5.24 (133) End 1 ID: 2.24 (57) End 2 ID: 2.95 (75)
HF35310  ARGO P3052051 Overall Height: 7.84 (199) Overall OD: 1.77 (45) BPV Setting: 4.35 (30) End 1 ID: 0.75 (19) End 2 ID: 0.59 (15)	HF35319  ARGO P3052001 Overall Height: 7.84 (199) Overall OD: 1.77 (45) End 1 ID: 0.75 (19)	HF35329  LIEBHERR 7373881 Overall Height: 24.80 (630) End 1 OD: 6.13 (156) End 2 OD: 5.98 (152) End 1 ID: 3.94 (100) End 2 ID: 3.17 (81)
HF35311  ARGO P3052052 Overall Height: 7.84 (199) Overall OD: 1.77 (45) BPV Setting: 29.01 (200) End 1 ID: 0.75 (19) End 2 ID: 0.59 (15)	HF35320  FENDT F916100600010 Overall Height: 7.82 (199) Overall OD: 2.76 (70) End 1 ID: 0.98 (25)	HF35330  LIEBHERR 7624324 Overall Height: 13.43 (341) End 1 OD: 6.13 (156) End 2 OD: 5.98 (152) End 1 ID: 3.94 (100) End 2 ID: 3.17 (81)
HF35312  PARKER GO4244 Overall Height: 4.98 (127) Overall OD: 2.09 (53) End 1 ID: 0.79 (20)	HF35322  VALMET 20639610 Overall Height: 7.09 (180) End 1 OD: 2.87 (73) End 2 OD: 2.84 (72) End 1 ID: 1.22 (31)	HF35333  KALMAR 9216890007 Overall Height: 7.87 (200) Overall OD: 3.68 (94) End 1 ID: 1.87 (48)
HF35313  FENDT G178860060030 Overall Height: 7.84 (199) Overall OD: 2.32 (59) BPV Setting: 25.38 (175) End 1 ID: 1.06 (27) End 2 ID: 0.59 (15)	HF35323  COOPERS LSF5170 TERBERG 28040481 Replaces HF35042 Overall Height: 5.69 (145) Largest OD: 3.70 (94) Thread Size: 1 1/8-16 UN-2B	



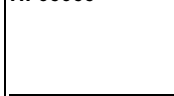



E. PRODUCT GUIDE

	<p>HF35334 KALMAR 9216890009</p> <p>Overall Height: 9.63 (245) Overall OD: 2.64 (67) End 1 ID: 0.98 (25)</p>
	<p>HF35336 VOLVO CONSTRUCTION EQUIPMENT 11705962</p> <p>Overall Height: 17.60 (447) BPV Setting: 43.51 (300) End 1 OD: 3.72 (95) End 2 OD: 3.74 (95) End 1 ID: 1.91 (49)</p>
	<p>HF35337 VOGELE 9624541001</p> <p>Overall Height: 15.71 (399) Overall OD: 4.49 (114) End 1 ID: 2.64 (67)</p>
	<p>HF35338 CASE 1976934C5 Delivered with O-ring gasket 3962133 and Rectangular gasket 3962134</p> <p>Overall Height: 7.87 (200) Largest OD: 5.04 (128) Thread Size: 1 1/2-16 UN-2B</p>
	<p>HF35339 JOHN DEERE AL156624</p> <p>Overall Height: 5.18 (132) Largest OD: 3.84 (98) Thread Size: 1 3/8-12 UNF-2B</p>
	<p>HF35340 JOHN DEERE AL118321</p> <p>Overall Height: 9.21 (234) Overall OD: 3.15 (80) End 1 ID: 1.54 (39)</p>
	<p>HF35341 RENAULT V.I. 5010403652</p> <p>Overall Height: 5.59 (142) Largest OD: 3.68 (94) BPV Setting: 36.26 (250) Thread Size: 3/4-16 UNF-2B</p>
	<p>HF35342 NEW HOLLAND 47108133</p> <p>Overall Height: 5.02 (128) End 1 OD: 4.29 (109) End 2 OD: 3.92 (100) Thread Size: M48 X 2-6H INT</p>
	<p>HF35343 JOHN DEERE AL160771</p> <p>Overall Height: 10.28 (261) Overall OD: 3.09 (79) End 1 ID: 1.65 (42)</p>



















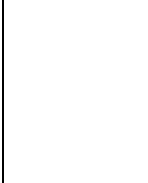

	<p>HF35344 CATERPILLAR 1494533 5 micron filter. Use the HF6542 for 10 micron filter</p> <p>Overall Height: 8.268 Dome OD: 3.67 Thread Size: 3/4 -14 BSP</p>
	<p>HF35345 CLAAS 689590</p> <p>Overall Height: 7.13 (181) Largest OD: 3.78 (96) BPV Setting: 43.51 (300) Thread Size: 1-12 UNF-2B</p>
	<p>HF35346 LIEBHERR 7028505</p> <p>Overall Height: 20.47 (520) End 1 OD: 6.13 (156) End 2 OD: 5.98 (152) End 1 ID: 3.94 (100) End 2 ID: 3.66 (93)</p>
	<p>HF35354 HITACHI 4067977</p> <p>Overall Height: 20.91 (531) Overall OD: 5.91 (150) End 1 ID: 4.33 (110)</p>
	<p>HF35355 CATERPILLAR 1261813</p> <p>Overall Height: 5.52 (140) Largest OD: 3.13 (80) Thread Size: 2-16 UN-2B</p>
	<p>HF35357 DOOSAN INFRACORE EUROPE SA 47400055</p> <p>Overall Height: 17.72 (450) Overall OD: 5.91 (150) End 1 ID: 4.33 (110)</p>
	<p>HF40003 JOHN DEERE AT306605 Applied on John Deere Graders</p> <p>Overall Height: 9.19 (233) Largest OD: 3.86 (98) Thread Size: M72 X 2-7H INT</p>

Hydraulic Heads

















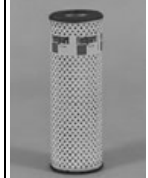





	<p>HH6926 Filter head w/1-5/16"-12 SAE Indicator Type: None For HF6600 Series</p>	<p>HH6957 Head used with FS1285 Filter head for HF6700 Series w/1" NPTF inlet/outlet. No by-pass. Drawing on page 1226 of Book 1 (2002-2003) is incorrect. Thread for hole gauge (restriction indicator) is 3/4-16 UNF-2B</p>
	<p>HH6931 Filter head w/1-1/16" 12 SAE Indicator Type: Electric For HF6600 Series</p>	<p>HH6960 Uses service part: 3929251S Filter head for HF6700 Series w/1" NPTF inlet/outlet. 25 PSI by-pass. With 15 psi DP electric indicator. Drawing on page 1226 of Book 1 (2002-2003) is incorrect.</p>

	<p>HH6932 Filter head w/1-1/16" 12 SAE Indicator Type: None For HF6600 Series</p>
	<p>HH6936 Filter head w/1-1/16" 12 SAE Indicator Type: None For HF6600 Series</p>
	<p>HH6942 Filter head w/ 3/4"-14 NPTF Indicator Type: None For HF6600 Series</p> <p>Height: 3.37 (85.6) Length: 4:20 (106.68) Thread Size: 1 1/16-2 UN-2B</p>
	<p>HH6951 Head used with FS1285 Uses service part: 3929251S Filter head for HF6700 Series w/1-5/16"-12 SAE o-ring seal inlet/outlet. No by-pass. Drawing on page 1226 of Book 1 (2002-2003) is incorrect.</p>
	<p>HH6952 JOHN DEERE AT144995 Head used with HF6802, HF6338, HF6824, HF6808, HF6809, HF6579, HF6831</p>
	<p>HH6955 Uses service part: 3929251S Filter head for HF6700 Series w/1 5/16"SAE o-ring seal inlet/outlet. 25 PSI by-pass. Drawing on page 1226 of Book 1 (2002-2003) is incorrect.</p>

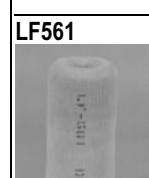











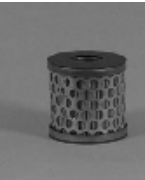









E. PRODUCT GUIDE

HH6961  Uses service part: 3929251S Filter head for HF6700 Series w/1" NPTF inlet/outlet. 25 PSI by-pass. Drawing on page 1226 of Book 1 (2002-2003) is incorrect.	LF507 DELUXE SD  Gasket: 250906 Overall Height: 8.50 (216) Overall OD: 4.87 (124) End 1 ID: 3.00 (76) End 2 ID: 0.56 (14)	LF516  CUMMINS 158139 Filter used with 252916S Uses service part: 116024S, 153516S, 153518S, 153520S, 153528S, 173368S, 181592S, 183342S, 251152S, 252917S, 254028S, 3301949S, 3301950S, 3301954S, 3301956S, 8265S, S1914S Gasket: 116024 ¹⁰ , 153528 ¹² , 169802 ¹² , 173368 ¹⁰ , 194982 ¹² , 69751 ¹⁰ , S1914S ¹⁰ Overall Height: 9.66 (245) Overall OD: 5.00 (127) End 1 ID: 1.48 (37)
HH33000 JOHN DEERE AT182208 Head used with HF28731	LF508 CUMMINS 299508  Gasket: 250907 Overall Height: 10.00 (254) Overall OD: 5.75 (146) End 1 ID: 3.75 (95) End 2 ID: 0.87 (22)	LF518 WHITE 673374  Gasket: 250908 ¹⁰ Overall Height: 17.25 (438) Overall OD: 6.50 (165) End 1 ID: 2.38 (60)
HH33076 Replaces Q54365 Mounting Head 1-1/4 in. - 12 Thread	LF509N AC PF132W, CASE 22038 Filter used with 253621S Uses service part: 153520S, 173368S, 250439S, 253312S, 254005S, 254098S, 317237S, 3302134S, 3302136S, 3832879S Lube application only For hydraulic and transmission application use HF6118  Gasket: 173368 ¹⁰ , 254005 ¹⁰ , 317237, 3301338 ¹⁰ , 333639, 3841722 Overall Height: 8.91 (226) Overall OD: 4.51 (115) End 1 ID: 1.44 (37)	LF519 CATERPILLAR 5S485 Uses service part: 251311S  Gasket: 251311 ¹⁰ Overall Height: 9.05 (230) Overall OD: 5.08 (129) End 1 ID: 3.32 (84)
Lube Filters LF500  FIAT-ALLIS 70061817, FIAT- ALLIS 70062101, CUMMINS 256839, MACK 236GB36 Filter used with 3952025S, 3952026S Uses service part: 159667S, 164159S, 250856S, 252274S, 254511S, 3301385S, 3301387S Gasket: 101853 ¹⁰ , 164159 ¹⁰ , 251432 ¹⁰ , 256981 ¹⁰ Overall Height: 10.06 (256) Overall OD: 7.72 (196) End 1 ID: 1.10 (28)	LF509AN Fram Housing FH33PL  Gasket: 3841722 Overall Height: 8.91 (226) Overall OD: 4.51 (115) End 1 ID: 1.44 (37)	LF520 CASE 34457, EUCLID 9028091, MACK 236GB123A  Overall Height: 7.55 (192) Overall OD: 5.84 (148) End 1 ID: 1.71 (43)
LF503  CLARK 957577, VOLVO CONSTRUCTION EQUIPMENT 957577, CASE A13211, CASE 603711C92, CARRIER 20122093 Uses service part: 253200S For lube application only. For fuel application use FF102.(Used in Fram Housing on GM Auto & Truck applications) Gasket: 250420 ¹⁰ , 253200 ¹⁰ , 3844314 Overall Height: 5.95 (151) Overall OD: 3.95 (100) End 1 ID: 1.08 (27)	LF510 CASE 367488R91 Fram F-4 Series  Gasket: 3846494 Overall Height: 4.87 (124) Overall OD: 3.97 (101) End 1 OD: 3.98 (101) End 1 ID: 0.54 (14)	LF521 CASE 193187R91  Gasket: 3315150 Overall Height: 7.00 (178) Overall OD: 4.52 (115) End 1 ID: 0.53 (13) End 2 ID: 1.77 (45)
LF504 GMC 5572425  Gasket: 3312307 Overall Height: 7.71 (196) End 1 OD: 4.03 (102) End 1 ID: 0.55 (14)	LF512 FORD C1TZ6731B  Gasket: 317703, 321293, 333639 Overall Height: 4.76 (121) Overall OD: 4.03 (102) End 1 ID: 0.80 (20)	LF522 CASE 214731R91  Gasket: 319604, 333786 Overall Height: 5.06 (129) Overall OD: 4.52 (115) End 1 ID: 0.53 (13) End 2 ID: 2.25 (57)
LF505 UNITED ENGINE LIFE EJC  Gasket: 250904 Overall Height: 5.25 (133) Overall OD: 4.00 (102) End 1 ID: 1.25 (32) End 2 ID: 0.56 (14)	LF513 AC P115  Gasket: 3312307 Overall Height: 4.87 (124) Overall OD: 3.97 (101) End 1 ID: 0.54 (14)	LF523 CASE 213445R91  Gasket: 319604, 333786 Overall Height: 7.06 (179) End 1 OD: 4.52 (115) End 2 OD: 4.51 (115) End 1 ID: 0.53 (13) End 2 ID: 2.25 (57)
LF506 UNITED ENGINE LIFE ECUR, CASE 70690H  Gasket: 250904, 250905 Overall Height: 5.50 (140) Overall OD: 4.12 (105) End 1 ID: 1.69 (43) End 2 ID: 0.56 (14)		

E. PRODUCT GUIDE

<p>LF524 GMC 5572128, GMC 5572286</p>  <p>Gasket: 250494, 3826219 Overall Height: 6.16 (156) Overall OD: 3.50 (89) End 1 ID: 1.15 (29)</p>	<p>LF543 MICHIANA SA5553</p>  <p>Gasket: 252471 Overall Height: 9.62 (244) Overall OD: 3.12 (79) End 1 ID: 0.88 (22)</p>	<p>LF553 GMC 5574406, 5574540</p>  <p>Gasket: 251150 Overall Height: 5.67 (144) Overall OD: 3.50 (89) End 1 ID: 1.34 (34)</p>
<p>LF525 GMC 5574978 Uses service part: 250439S</p>  <p>Gasket: 255677, 3826212 Overall Height: 5.82 (148) Overall OD: 4.51 (115) End 1 ID: 1.44 (37)</p>	<p>LF544 MACK 43SB38</p>  <p>Overall Height: 8.87 (225) Overall OD: 6.50 (165) End 1 ID: 0.33 (8) Thread Size: 3/8-24 UNF-2B</p>	<p>LF556 GMC 5570675</p>  <p>Gasket: 251371 Overall Height: 17.25 (438) Overall OD: 4.88 (124) End 1 ID: 0.61 (15)</p>
<p>LF526 CASE 33316, CHRYSLER 1193505, MASSEY-FERGUSON 76099M1</p>  <p>Gasket: 250408 Overall Height: 6.04 (153) Overall OD: 3.95 (100) End 1 ID: 0.86 (22)</p>	<p>LF546 CATERPILLAR 9F6742</p>  <p>Gasket: 333637 Overall Height: 8.94 (227) Overall OD: 3.06 (78) End 1 ID: 1.50 (38)</p>	<p>LF558 CATERPILLAR 7M3800 Caterpillar 5S-484, 7M-3800</p>  <p>Gasket: 3309354, 3310707 Overall Height: 9.25 (235) Overall OD: 4.00 (102) End 1 ID: 1.64 (42)</p>
<p>LF528 Fram F-44 Series</p>  <p>Gasket: 250413 Overall Height: 14.60 (371) Overall OD: 5.83 (148) End 1 ID: 0.99 (25)</p>	<p>LF548 DELUXE 30 Uses service part: 250439S</p>  <p>Gasket: 333646 Overall Height: 4.80 (122) Overall OD: 4.03 (102) End 1 ID: 0.55 (14)</p>	<p>LF559 CHRYSLER 1312602, CHRYSLER 1610435 Not available in all parts of the world.</p>  <p>Gasket: 333636, 333650 Overall Height: 6.55 (166) Overall OD: 3.53 (90) End 1 ID: 1.12 (28)</p>
<p>LF530 FIAT-ALLIS 70034914, FIAT-ALLIS 70090824, GMC 1595635</p>  <p>Gasket: 250502, 251373 Overall Height: 6.11 (155) Overall OD: 3.97 (101) End 1 ID: 0.71 (18)</p>	<p>LF549 AC C285</p>  <p>Gasket: 251368 Overall Height: 12.00 (305) Overall OD: 4.12 (105) End 1 ID: 1.25 (32) End 2 ID: 0.75 (19)</p>	<p>LF560 CHRYSLER 1557576, CHRYSLER 1634447, CHRYSLER 2129023</p>  <p>Gasket: 3314859, 333639, 3844191, 3844455, 3844456 Overall Height: 4.08 (104) Overall OD: 2.98 (76) End 1 ID: 0.08 (2)</p>
<p>LF533 COMMERCIAL 8548</p>  <p>Gasket: 255067, 255068 Overall Height: 2.00 (51) Overall OD: 2.62 (67) End 1 ID: 1.25 (32) End 2 ID: 1.00 (25)</p>	<p>LF550 FORD C5TE6744A Uses service part: 250394S</p>  <p>Gasket: 250399, 250569, 252398 Overall Height: 4.82 (122) Overall OD: 4.98 (126) End 1 ID: 0.77 (20)</p>	<p>LF561 WHITE 639976A</p>  <p>Gasket: 251368 Overall Height: 8.88 (226) Overall OD: 4.00 (102) End 1 ID: 1.62 (41) End 2 ID: 1.25 (32)</p>
<p>LF534 Case/International For V-8 Engines Base Mounted Deluxe CU Filter</p>  <p>Gasket: 250666 Overall Height: 5.50 (140) Overall OD: 4.12 (105) End 1 ID: 2.50 (64) End 2 ID: 0.56 (14)</p>	<p>LF551A CASE 1959757C1 For Upgrade, use LF3487</p>  <p>Overall Height: 5.40 (137) Largest OD: 3.78 (96) ADBV: Yes BPV Setting: 10.01 (69) Thread Size: 3/4-16 UNF-2B</p>	<p>LF563 CASE 323827R91, CASE 279994R91</p>  <p>Gasket: 326960 Overall Height: 5.58 (142) Overall OD: 4.00 (102) End 1 ID: 1.61 (41)</p>
<p>LF542 MICHIANA SA15117</p>  <p>Gasket: 250457, 250854 Overall Height: 6.78 (172) Overall OD: 3.50 (89) End 1 ID: 0.54 (14)</p>	<p>LF552 FORD C1TZ6731D, FORD B8C6731A Uses service part: 250394S</p>  <p>Gasket: 105209, 250399, 258801 Overall Height: 4.74 (120) Overall OD: 3.50 (89) End 1 ID: 0.78 (20)</p>	<p>LF564 WHITE 872946A, WHITE 156149AS</p>  <p>Gasket: 250904, 3309923 Overall Height: 7.88 (200) Overall OD: 3.50 (89) End 1 ID: 1.50 (38) End 2 ID: 1.25 (32)</p>

E. PRODUCT GUIDE

LF566  CASE 376364R91 Gasket: 323311, 3844476, 3844477 Overall Height: 5.33 (135) Overall OD: 2.75 (70) End 1 ID: 1.31 (33)	LF574  Fram F-3 Series Gasket: 3842864 Overall Height: 4.33 (110) Overall OD: 3.50 (89) End 1 ID: 0.54 (14)	LF590  GMC 5572669 Not available in all parts of the world. Gasket: 257499 Overall Height: 4.22 (107) Overall OD: 3.50 (89) End 1 ID: 1.06 (27)
LF567  LISTER PETTER 208378, LISTER PETTER 268378 Overall Height: 2.06 (52) Overall OD: 2.05 (52) End 1 ID: 0.86 (22)	LF575  FRAM FH1PL Gasket: 3844238 Overall Height: 4.02 (102) Overall OD: 2.96 (75) End 1 ID: 0.77 (20)	LF592  GMC 5570144 Overall Height: 6.40 (163) Largest OD: 3.87 (98) Thread Size: 2 3/4-4 MASON JAR
LF568  CASE 8152AB, MASSEY-FERGUSON 761515M1 Gasket: 3314859, 3842864, 3845222 Overall Height: 4.16 (106) Overall OD: 3.50 (89) End 1 ID: 0.71 (18)	LF577  MACK 236GB311A Gasket: 256981 ¹⁰ Overall Height: 15.10 (384) Overall OD: 7.50 (191) End 1 ID: 0.69 (18)	LF593  MICHIANA SA16317, MICHIANA SA16367 Gasket: 256037 Overall Height: 8.00 (203) Overall OD: 5.12 (130) End 1 ID: 0.75 (19)
LF569  Fram F-43 Series Gasket: 250413 Overall Height: 9.77 (248) Overall OD: 5.83 (148) End 1 ID: 0.99 (25)	LF580  FORD C5NN6714A, FORD C7NN6714A, FORD C9NN6714A Overall Height: 4.22 (107) Largest OD: 4.24 (108) ADBV: Yes BPV Setting: 7.98 (55) Thread Size: 3/4-16 UNF-2B	LF594  FORD E1ADKN18662B, PERKINS 26540055, MASSEY-FERGUSON 1882916M91 Gasket: 252286, 252287, 252288 Overall Height: 6.10 (155) Overall OD: 2.80 (71) End 1 ID: 1.30 (33)
LF570  CASE 268462R91 Gasket: 3844492, 3844493 Overall Height: 8.86 (225) Overall OD: 4.52 (115) End 1 ID: 1.71 (43)	LF581  For Upgrade, use LF3538 For Synthetic Media Version use LF3538 Overall Height: 5.32 (135) Largest OD: 3.77 (96) ADBV: Yes Thread Size: 13/16-16 UNS-2B	LF595  MERCEDES-BENZ 1844901 Gasket: 252269 Overall Height: 3.91 (99) Overall OD: 2.35 (60) End 1 ID: 0.70 (18)
LF571  FIAT-ALLIS 70204912, FIAT-ALLIS 70240912, FIAT-ALLIS 70800912, FIAT-ALLIS 70804912, MICHIANA SA18717 Overall Height: 4.86 (123) Largest OD: 3.54 (90) Thread Size: 2 3/4-4 MASON JAR	LF584  CASE 376375R91, CASE 355010R91 Overall Height: 7.72 (196) Overall OD: 3.35 (85) End 1 ID: 0.52 (13) End 2 ID: 0.86 (22)	LF596  HYSTER 156952, MASSEY-FERGUSON 1851766M1, PERKINS 26540132 Gasket: 252247 Overall Height: 4.53 (115) Overall OD: 2.75 (70) End 1 ID: 0.82 (21)
LF572  Fram F-30 Series Gasket: 3837975, 3846494 Overall Height: 7.71 (196) Overall OD: 4.03 (102) End 1 ID: 0.55 (14)	LF585  INTERNATIONAL TRUCKS 3062832R91, CASE 3062832R91 Overall Height: 7.42 (188) End 1 OD: 3.90 (99) End 2 OD: 3.89 (99) End 1 ID: 1.17 (30) End 2 ID: 0.63 (16)	LF598  CHRYSLER 2236054 Gasket: 252175, 3309762 Overall Height: 4.53 (115) Overall OD: 3.85 (98) End 1 ID: 1.32 (34)
LF573  HERCULES 212403A, WAUKESHA 50066, MICHIANA SA5453 Gasket: 255951, 255953 Overall Height: 7.12 (181) Overall OD: 3.25 (83) End 1 ID: 1.56 (40)	LF587  JOHN DEERE AA2092R, JOHN DEERE AA3680R, JOHN DEERE AT15088T Gasket: 326304, 326305 Overall Height: 6.51 (165) Overall OD: 3.36 (85) End 1 ID: 1.65 (42)	LF599  PERKINS 101606 Gasket: 252175 Overall Height: 3.78 (96) Overall OD: 3.50 (89) End 1 ID: 1.34 (34)

E. PRODUCT GUIDE

LF601 CATERPILLAR 8B5935



Gasket: 3824734
 Overall Height: 6.00 (152)
 Overall OD: 3.62 (92)
 End 1 ID: 1.50 (38)
 End 2 ID: 1.38 (35)

LF605 MURPHY MD15071



Overall Height: 31.00 (787)
 Overall OD: 3.27 (83)
 End 1 ID: 0.50 (13)
 Thread Size: 3/8 NPT

LF607 FIAT-ALLIS 74512207



Overall Height: 5.78 (147)
 Largest OD: 3.73 (95)
 Thread Size: 5/8-18 UNF-2B

LF610 CATERPILLAR 2S5262,
CATERPILLAR 9M8755



Overall Height: 4.21 (107)
 Largest OD: 3.71 (94)
 BPV Setting: 17.40 (120)
 Thread Size: 7/8-14 UNF-2B

LF613 Uses service part: 173368S,
193302S Cummins V6-140,
Vale V8-185 1965-ON 173174,
White



Gasket: 173368¹², 193302¹⁰
 Overall Height: 7.57 (192)
 Overall OD: 4.76 (121)
 End 1 ID: 1.51 (38)

LF614 PUROLATOR EP3



Overall Height: 1.56 (40)
 Overall OD: 3.09 (78)
 End 1 ID: 1.03 (26)

LF617 WAUKESHA 153297



Gasket: 252896
 Overall Height: 16.00 (406)
 Overall OD: 4.88 (124)
 End 1 ID: 1.25 (32)

LF618 CASE 376374R91



Gasket: 326010
 Overall Height: 5.72 (145)
 Overall OD: 3.35 (85)
 End 1 ID: 0.51 (13)
 End 2 ID: 0.86 (22)

LF619 Navy Standard Large Briggs



Overall Height: 18.75 (476)
 Overall OD: 6.75 (171)
 End 1 ID: 2.10 (53)

LF621 SCHRAMM COUB2295



Gasket: 253200
 Overall Height: 4.03 (102)
 Overall OD: 3.50 (89)
 End 1 ID: 1.06 (27)

LF624 CATERPILLAR 1L6946, CASE
259630R91



Gasket: 3844529
 Overall Height: 5.94 (151)
 Overall OD: 3.50 (89)
 End 1 ID: 0.54 (14)

LF628 CARRIER 2921046, CARRIER
21026A



Gasket: 252897
 Overall Height: 7.25 (184)
 Overall OD: 3.75 (95)
 End 1 ID: 1.25 (32)

LF629 Cummins Nugent 1280 Series
Cage Type



Gasket: 3300393
 Overall Height: 30.50 (775)
 Overall OD: 5.75 (146)
 End 1 ID: 2.00 (51)

LF631 Freightliner Rol-Pak R-20



Gasket: 253068
 Overall Height: 20.25 (514)
 Overall OD: 4.88 (124)
 End 1 ID: 1.18 (30)
 End 2 ID: 1.12 (28)

LF632B CUMMINS 170200 Uses
service part: 153717S



Overall Height: 5.42 (138)
 Largest OD: 3.69 (94)
 BPV Setting: 8.99 (62)
 Thread Size: 13/16-16 UNS-2B

LF633 DAVID BROWN 67307



Gasket: 3844530
 Overall Height: 3.33 (85)
 Overall OD: 2.75 (70)
 End 1 ID: 1.31 (33)

LF634 Fleetguard Power Steering
Reservoir



Gasket: 3312307
 Overall Height: 2.74 (70)
 Overall OD: 3.53 (90)
 End 1 ID: 1.38 (35)
 End 2 ID: 0.86 (22)

LF637 Fleetguard Power Steering
Reservoir



Gasket: 164159¹⁰, 252598¹⁰
 Overall Height: 4.15 (105)
 Overall OD: 5.12 (130)
 End 1 ID: 0.87 (22)
 End 2 ID: 1.49 (38)

LF638 Fleetguard Power Steering
Reservoir



Overall Height: 8.88 (226)
 Overall OD: 4.52 (115)
 End 1 ID: 1.71 (43)

LF640 FIAT-ALLIS 74349986 Uses
service part: 250439S



Gasket: 3832879
 Overall Height: 7.96 (202)
 Overall OD: 4.51 (115)
 End 1 ID: 1.44 (37)

LF647 GMC 6437462



Overall Height: 4.22 (107)
 Largest OD: 3.77 (96)
 ADBV: Yes
 Thread Size: 13/16-16 UNS-2B

LF651 AC PF25 Is a short version of
LF653 For Upgrade, use
LF3488



Overall Height: 4.15 (105)
 Largest OD: 3.69 (94)
 Thread Size: 13/16-16 UNS-2B

LF652 GMC 6437562



























Gasket: 3844541
 Overall Height: 8.45 (215)
 Overall OD: 3.50 (89)
 End 1 ID: 1.34 (34)

LF653 Is a short version of LF692 Is a
longer version of LF651 For
Upgrade, use LF3488 GMC
Cars And Trucks























Overall Height: 5.41 (137)
 Largest OD: 3.69 (94)
 Thread Size: 13/16-16 UNS-2B

E. PRODUCT GUIDE

<p>LF654</p>  <p>CATERPILLAR 9L9200 For Upgrade, use LF3788</p> <p>Overall Height: 5.42 (138) Largest OD: 3.69 (94) BPV Setting: 22.02 (152) Thread Size: 1-12 UNF-2B</p>	<p>LF674</p>  <p>JOHN DEERE AH1111RT</p> <p>Overall Height: 4.21 (107) Overall OD: 3.50 (89) End 1 ID: 1.06 (27)</p>	<p>LF689</p>  <p>CHRYSLER 3549957, KOMATSU HE40000415 Is a short version of LF3313</p> <p>Overall Height: 4.22 (107) Largest OD: 3.80 (97) ADBV: Yes BPV Setting: 10.01 (69) Thread Size: 3/4-16 UNF-2B</p>
<p>LF655</p>  <p>FORD D0RY6731A, TOYOTA 1560133020</p> <p>Overall Height: 4.57 (116) Largest OD: 3.05 (77) ADBV: Yes Thread Size: 3/4-16 UNF-2B</p>	<p>LF677</p>  <p>FIAT-ALLIS 70647256</p> <p>Overall Height: 9.24 (235) Overall OD: 4.00 (102) End 1 ID: 1.64 (42)</p>	<p>LF690</p>  <p>CASE 427207C2</p> <p>Overall Height: 6.90 (175) Largest OD: 3.78 (96) ADBV: Yes BPV Setting: 10.01 (69) Thread Size: 1-12 UNF-2B</p>
<p>LF662</p>  <p>TOYOTA 415240030</p> <p>Overall Height: 5.15 (131) Overall OD: 2.90 (74) End 1 ID: 0.69 (18)</p>	<p>LF678</p>  <p>JOHN DEERE T19044T, RENAULT 6005012109, VAPORMATIC VPD5015</p> <p>Overall Height: 5.44 (138) Largest OD: 3.69 (94) BPV Setting: 22.04 (152) Thread Size: 13/16-16 UNS-2B</p>	<p>LF691</p>  <p>CATERPILLAR 1R0716 For Upgrade, use LF3374, LF9691 For Synthetic Media Version use LF3374</p> <p>Overall Height: 11.31 (287) Largest OD: 4.74 (120) Largest OD: 4.74 (120) Thread Size: 1 1/2-16 UNS-2B</p>
<p>LF666</p>  <p>CATERPILLAR 5J8877</p> <p>Overall Height: 6.00 (152) Overall OD: 5.08 (129) End 1 ID: 3.32 (84)</p>	<p>LF680</p>  <p>JOHN DEERE AR43634</p> <p>Gasket: 329753 Overall Height: 6.71 (170) Largest OD: 5.08 (129) Thread Size: 1 1/2-16 UN-2B</p>	<p>LF691A</p>  <p>CATERPILLAR 2P4005, CATERPILLAR 1R0716 Uses service part: 3838290S For Upgrade, use LF3566, LF9691A</p> <p>Overall Height: 12.19 (310) Largest OD: 5.41 (137) Thread Size: 1 1/2-16 UNS-2B</p>
<p>LF667</p>  <p>CATERPILLAR 2P4004, MACK 485GB3191 For Upgrade, use LF9667, LF3379</p> <p>Overall Height: 10.39 (264) Largest OD: 4.24 (108) Largest OD: 4.24 (108) Thread Size: 1 1/8-16 UN-2B</p>	<p>LF682</p>  <p>FIAT-ALLIS 74513411</p> <p>Overall Height: 5.69 (145) Largest OD: 4.24 (108) ADBV: Yes BPV Setting: 17.40 (120) Thread Size: 3/4-16 UNF-2B</p>	<p>LF692</p>  <p>GMC 6439034 Is a longer version of LF653</p> <p>Overall Height: 7.91 (201) Largest OD: 3.72 (94) Thread Size: 13/16-16 UNS-2B</p>
<p>LF670</p>  <p>CUMMINS 3313279, CUMMINS 3889310 Uses service part: 3001483S, 3302630S, 3302631S, 3303782S, 3318568S, 3927995S For Upgrade, use LF3363, LF9325 For adaptors to convert to LF670 see Lube System Service Parts section.</p> <p>Overall Height: 9.81 (249) Largest OD: 4.67 (119) Thread Size: 1 1/2-12 UNS-2B</p>	<p>LF684</p>  <p>CASE A40902, FIAT-ALLIS 70246085</p> <p>Overall Height: 5.66 (144) End 1 OD: 2.97 (75) End 2 OD: 2.90 (74) End 1 ID: 1.04 (26)</p>	<p>LF694</p>  <p>THERMO-KING 113712 Standard Service Interval</p> <p>Overall Height: 6.91 (176) Largest OD: 3.69 (94) Thread Size: 1-12 UNF-2B</p>
<p>LF672</p>  <p>IH 376373-R91</p> <p>Overall Height: 4.63 (118) End 1 OD: 2.30 (58) End 2 OD: 2.31 (59) End 1 ID: 0.44 (11) End 2 ID: 0.51 (13)</p>	<p>LF687</p>  <p>GMC 5578261</p> <p>Gasket: 3301748, 3301749, 3301750, 3301751¹¹ Overall Height: 8.45 (215) Overall OD: 2.88 (73) End 1 ID: 1.18 (30)</p>	<p>LF695</p>  <p>THERMO-KING 113746</p> <p>Overall Height: 7.14 (181) Largest OD: 4.24 (108) Thread Size: 3/4-20 UNEF-2B</p>
<p>LF673</p>  <p>CASE 528250R1</p> <p>Overall Height: 7.99 (203) Largest OD: 3.72 (94) BPV Setting: 13.49 (93) Thread Size: 1-12 UNF-2B</p>	<p>LF688</p>  <p>KOMATSU 6610554400</p> <p>Gasket: 3842849 Overall Height: 9.30 (236) Overall OD: 4.96 (126) End 1 ID: 2.20 (56)</p>	<p>LF697</p>  <p>FORD D3HZ6731B</p> <p>Overall Height: 6.90 (175) Largest OD: 3.78 (96) ADBV: Yes BPV Setting: 9.57 (66) Thread Size: 3/4-16 UNF-2B</p>

E. PRODUCT GUIDE

<p>LF699 PERKINS 2654407</p>  <p>Overall Height: 6.86 (174) Largest OD: 3.69 (94) Standpipe: YES ADBV: Yes BPV Setting: 11.02 (76) Thread Size: 3/4-16 UNF-2B</p>	<p>LF723 GALION B67373, KOMATSU 67373</p>  <p>Overall Height: 12.00 (305) Overall OD: 5.00 (127) End 1 ID: 2.57 (65)</p>	<p>LF740 KOMATSU 6120505103</p>  <p>Overall Height: 9.13 (232) Overall OD: 4.00 (102) End 1 ID: 1.64 (42)</p>
<p>LF700 PERKINS 2654408</p>  <p>Largest OD: 3.05 (77) ADBV: Yes ADBV: 12.50 (86) BPV Setting: 11.02 (76) Thread Size: 3/4-16 UNF-2B</p>	<p>LF725 CLARK 1810889</p>  <p>Overall Height: 12.29 (312) Overall OD: 4.47 (114) End 1 ID: 1.87 (48)</p>	<p>LF742 KUBOTA 1540232090, VAPORMATIC VPD5018</p>  <p>Overall Height: 4.16 (106) Largest OD: 3.70 (94) ADBV: Yes BPV Setting: 35.53 (245) Thread Size: 3/4-16 UNF-2B</p>
<p>LF701 PERKINS 2654403, EAGLE PICHER 57247</p>  <p>Overall Height: 5.73 (146) Largest OD: 3.69 (94) Standpipe: YES ADBV: Yes BPV Setting: 11.02 (76) Thread Size: 3/4-16 UNF-2B</p>	<p>LF726 WISCONSIN RV40</p>  <p>Gasket: 3313135 Overall Height: 4.83 (123) Largest OD: 3.54 (90) Thread Size: 2 3/4-5.5 MASON JAR</p>	<p>LF746 INGERSOLL-RAND 35107424</p>  <p>Overall Height: 6.32 (161) Overall OD: 3.95 (100) End 1 ID: 1.08 (27)</p>
<p>LF702 THERMO-KING 113871 ESI Extended Service</p>  <p>Overall Height: 7.14 (181) Largest OD: 4.26 (108) Thread Size: 1-12 UNF-2B</p>	<p>LF727 WISCONSIN RV38</p>  <p>Overall Height: 5.68 (144) Largest OD: 3.81 (97) ADBV: Yes BPV Setting: 7.98 (55) Thread Size: 5/8-18 UNF-2B</p>	<p>LF747 KOMATSU 600211230 For Upgrade, use LF3453, LF9747 For Synthetic Media Version use LF3453</p>  <p>Overall Height: 11.31 (287) Largest OD: 4.57 (116) Largest OD: 4.74 (120) Thread Size: 1 1/2-12 UNS-2B</p>
<p>LF703 CASE 684206C1</p>  <p>Overall Height: 9.81 (249) Largest OD: 4.74 (120) Thread Size: 1 1/2-16 UNS-2B</p>	<p>LF733 ALLIS-CHALMERS 4036791</p>  <p>Overall Height: 10.39 (264) Largest OD: 4.24 (108) Thread Size: 1 1/8-16 UN-2B</p>	<p>LF750A Uses service part: 159667S, 164159S, 250856S, 252274S, 254511S, 258814S, 259073S, 3301385S, 3301387S, 3304635S, 3305154S, 3952028S, 3952029S Used with 3952027S Premium Element 4 Pack 8% more media than LF750D. Poly wrapped</p> 
<p>LF708 KOMATSU 6002115213</p>  <p>Overall Height: 6.88 (175) Largest OD: 3.78 (96) ADBV: Yes BPV Setting: 20.16 (139) Thread Size: 1-12 UNF-2B</p>	<p>LF734 CUMMINS 3014654, HITACHI 4206089 Cummins Small Vee</p>  <p>Overall Height: 8.09 (205) Largest OD: 4.74 (120) Thread Size: 1 1/2-12 UNS-2B</p>	<p>Gasket: 101853¹⁰, 164159¹⁰, 251432¹⁰, 256981¹⁰ Overall Height: 15.06 (383) Height: 15.12 (384) Overall OD: 7.72 (196) End 1 OD: 7.75 (197) End 1 ID: 1.10 (28) End 1 ID: 0.88 (22)</p>
<p>LF716 FORD D27Z6731A</p>  <p>Overall Height: 4.58 (116) Largest OD: 3.05 (77) ADBV: Yes BPV Setting: 17.40 (120) Thread Size: M20 X 1.5-6H INT</p>	<p>LF735 FIAT-ALLIS 70631828, FIAT-ALLIS 70694662</p>  <p>Overall Height: 7.59 (193) Overall OD: 2.61 (66) End 1 ID: 1.01 (26)</p>	
<p>LF720 NISSAN 1520861525 3844545 washer included</p>  <p>Gasket: 3844527, 3844543 Overall Height: 6.16 (156) End 1 OD: 3.98 (101) End 2 OD: 3.97 (101) End 1 ID: 1.68 (43) End 2 ID: 0.59 (15)</p>	<p>LF739 FIAT-ALLIS 74023548</p>  <p>Overall Height: 5.74 (146) Largest OD: 4.24 (108) Thread Size: 1-16 UN-2B</p>	

E. PRODUCT GUIDE

LF750B



Uses service part: 159667S, 164159S, 250856S, 252274S, 254511S, 258814S, 259073S, 3301385S, 3301387S, 3304635S, 3305154S, 3952028S, 3952029S Used with 3952027S Premium Element 4 Pack 8% more media than LF750D not poly wrapped

Gasket: 101853¹⁰, 164159¹⁰, 251432¹⁰, 256981¹⁰
 Overall Height: 15.06 (383)
 Height: 15.12 (384)
 Overall OD: 7.72 (196)
 End 1 OD: 7.75 (197)
 End 1 ID: 1.10 (28)
 End 1 ID: 0.88 (22)

LF750D



Uses service part: 3952028S, 3952029S Used with 3952027S Economy Element 4 Pack Not for use on turbocharged engines. Not poly wrapped

Gasket: 101853¹⁰, 164159¹⁰, 251432¹⁰, 256981¹⁰
 Overall Height: 15.06 (383)
 Height: 15.12 (384)
 Overall OD: 7.72 (196)
 End 1 OD: 7.75 (197)
 End 1 ID: 1.10 (28)
 End 1 ID: 0.88 (22)

LF756



MERCEDES-BENZ 11844425

Gasket: 3844567, 3844568
 Overall Height: 5.21 (132)
 Overall OD: 3.23 (82)
 End 1 ID: 1.00 (25)

LF760



GMC 25012636, MITSUBISHI FP100074

Overall Height: 5.22 (133)
 Largest OD: 3.72 (94)
 ADBV: Yes
 BPV Setting: 28.57 (197)
 Thread Size: 1-12 UNF-2B

LF762



INGERSOLL-RAND 35110527

Overall Height: 7.51 (191)
 Overall OD: 5.84 (148)
 End 1 ID: 1.71 (43)

LF764



ATLAS COPCO 10300882

Overall Height: 3.75 (95)
 Largest OD: 3.81 (97)
 ADBV: Yes
 BPV Setting: 22.04 (152)
 Thread Size: 3/4-16 UNF-2B

LF767



GMC 25010324

Overall Height: 4.58 (116)
 Largest OD: 3.05 (77)
 ADBV: Yes
 Thread Size: 13/16-16 UNS-2B

LF777



CUMMINS 3889311 Filter used with 3304173S Uses service part: 3318566S 2.0 GPM flow rates

Overall Height: 9.81 (249)
 Largest OD: 4.57 (116)
 Largest OD: 4.74 (120)
 Thread Size: 1 3/8-16 UNS-2B

LF778



CARRIER 300030400

Overall Height: 6.91 (176)
 Largest OD: 3.69 (94)
 Thread Size: 5/8-18 UNF-2B

LF779



MERCEDES-BENZ 1800009

Overall Height: 4.62 (117)
 Overall OD: 3.01 (76)
 End 1 ID: 0.87 (22)

LF780



GMC 25010792 Is a short version of LF782

Overall Height: 3.49 (89)
 Largest OD: 3.05 (77)
 ADBV: Yes
 Thread Size: M18 X 1.5-6H INT

LF781



NISSAN 1520813210, NISSAN 1520813201, NISSAN 1520813211, TOYOTA 1560122010 GMC 6437982

Overall Height: 5.91 (150)
 Largest OD: 3.05 (77)
 ADBV: Yes
 Thread Size: 3/4-16 UNF-2B

LF782



GMC 25010908, GMC 25012760 Is a longer version of LF780 For Upgrade, use LF3554

Overall Height: 4.57 (116)
 Largest OD: 3.05 (77)
 ADBV: Yes
 Thread Size: M18 X 1.5-6H INT

LF783



Overall Height: 3.24 (82)
 Largest OD: 3.69 (94)
 ADBV: Yes
 Thread Size: M18 X 1.5-6H INT

LF785



FORD 2735E6714B, JOHN DEERE AM34770, V.A.G. (VOLKSWAGEN, AUDI) 34115561A, MANIPARTS 486309, AMERICAN MOTORS 3250334

Largest OD: 3.05 (78)
 ADBV: Yes
 ADBV: 29.00 (200)
 BPV Setting: 30.02 (207)
 Thread Size: 3/4-16 UNF-2B

LF786



ALLIS-CHALMERS 4107775, ALLIS-CHALMERS 4083490

Overall Height: 3.85 (98)
 Largest OD: 3.73 (95)
 Thread Size: 5/8-18 UNF-2B

LF787



MASSEY-FERGUSON 881446M91

Overall Height: 6.86 (174)
 Largest OD: 3.80 (97)
 ADBV: Yes
 BPV Setting: 7.98 (55)
 Thread Size: 3/4-16 UNF-2B

LF788



M&W GEAR 4E023

Overall Height: 5.42 (138)
 Largest OD: 3.69 (94)
 BPV Setting: 7.98 (55)
 Thread Size: 5/8-18 UNF-2B

LF790



CASE A59110, CASE A62423, WHITE 400000406

Overall Height: 8.11 (206)
 Largest OD: 4.24 (108)
 ADBV: Yes
 Thread Size: 7/8-16 UN-2B

LF791



FORD 113E6714A

Gasket: 317730, 317733
 Overall Height: 4.19 (106)
 Overall OD: 2.81 (71)
 End 1 ID: 1.31 (33)

LF792



WHITE 10A10423

Overall Height: 6.24 (159)
 Overall OD: 4.54 (115)
 End 1 ID: 0.88 (22)





















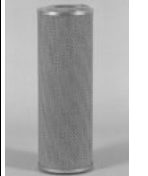

LF793

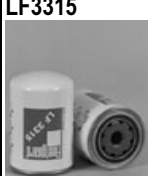





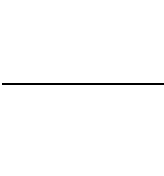



















CASE A21475

Gasket: 317703, 326452, 333639
 Overall Height: 4.76 (121)
 Overall OD: 4.03 (102)
 End 1 ID: 0.80 (20)





















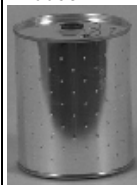



E. PRODUCT GUIDE

<p>LF794</p>  <p>WAUKESHA 101710, WAUKESHA 119390</p> <p>Overall Height: 7.35 (187) Largest OD: 3.75 (95) Thread Size: 2-4 MASON JAR</p>	<p>LF3300</p>  <p>WHITE 167143AS</p> <p>Gasket: 327393, 3825979 Overall Height: 7.12 (181) Overall OD: 4.52 (115) End 1 ID: 1.43 (36)</p>	<p>LF3311</p>  <p>ONAN 1220185, WHITE 156513AS</p> <p>Overall Height: 3.75 (95) Largest OD: 3.79 (96) ADBV: Yes BPV Setting: 7.98 (55) Thread Size: 3/4-16 UNF-2B</p>
<p>LF795</p>  <p>HONDA 15400634003, MAZDA 489914300</p> <p>Overall Height: 3.22 (82) Largest OD: 3.78 (96) ADBV: Yes BPV Setting: 13.49 (93) Thread Size: M20 X 1.5-6H INT</p>	<p>LF3302</p>  <p>WHITE 169019A</p> <p>Overall Height: 6.91 (176) Largest OD: 3.70 (94) ADBV: Yes BPV Setting: 13.49 (93) Thread Size: 7/8-14 UNF-2B</p>	<p>LF3312</p>  <p>BRIGGS & STRATTON A414</p> <p>Overall Height: 15.75 (400) Overall OD: 6.00 (152) End 1 ID: 2.58 (66)</p>
<p>LF796</p>  <p>AC PF39, AC PF44, AC PF46 Product is not available in all regions of the world.</p> <p>Overall Height: 3.49 (89) Largest OD: 3.05 (77) ADBV: Yes Thread Size: 13/16-16 UNS-2B</p>	<p>LF3303</p>  <p>WHITE 10A132</p> <p>Overall Height: 9.50 (241) Overall OD: 6.50 (165) End 1 ID: 0.82 (21)</p>	<p>LF3313</p>  <p>FORD D8PJ6714AA Is a longer version of LF689 For Upgrade, use LF3487</p> <p>Overall Height: 5.32 (135) Largest OD: 3.78 (96) ADBV: Yes BPV Setting: 10.01 (69) Thread Size: 3/4-16 UNF-2B</p>
<p>LF797</p>  <p>CASE A44081</p> <p>Overall Height: 7.91 (201) Largest OD: 3.72 (94) Thread Size: 1-12 UNF-2B</p>	<p>LF3304</p>  <p>COMMERCIAL 4649, PECO PP71810</p> <p>Overall Height: 17.88 (454) Overall OD: 6.19 (157) End 1 ID: 2.56 (65)</p>	<p>LF3314</p>  <p>NISSAN 1520865001, NISSAN 1520865002, NISSAN 1520865011, NISSAN 1520865012</p> <p>Overall Height: 5.76 (146) Largest OD: 3.78 (96) ADBV: Yes BPV Setting: 10.01 (69) Thread Size: 3/4-16 UNF-2B</p>
<p>LF798</p>  <p>CHRYSLER 4026486</p> <p>Overall Height: 4.22 (107) Largest OD: 3.74 (95) ADBV: Yes BPV Setting: 17.40 (120) Thread Size: M20 X 1.5-6H INT</p>	<p>LF3305</p>  <p>CASE A20822</p> <p>Overall Height: 7.00 (178) Overall OD: 4.52 (115) End 1 ID: 1.77 (45) End 2 ID: 0.88 (22)</p>	<p>LF3315</p>  <p>FORD 785F6714AA3A</p> <p>Overall Height: 5.61 (143) Largest OD: 3.68 (94) ADBV: Yes BPV Setting: 17.40 (120) Thread Size: M22 X 1.5-6H INT</p>
<p>LF3000</p>  <p>CUMMINS 3318853, BIURRARENA 143115 Filter used with 3827195S, 3834123S, 3836091S Uses service part: 3305536S, 3826332S, 3826333S, 3826334S, 3826335S, 3826336S, 3826359S, 3826360S, 3826362S, 3835862S For Upgrade, use LF9009 Uses Service gasket: 3831773S Combination Synthetic Media full flow and stacked disc bypass Can be used to replace LF670, LF777, LF691 and LF3333 See service parts section for adaptors</p> <p>Overall Height: 11.88 (302) Largest OD: 4.68 (119) Standpipe: YES Thread Size: 2 1/4-12 UNS-2B</p>	<p>LF3307</p>  <p>CASE A58672, ISUZU 2906549000</p> <p>Overall Height: 6.82 (173) Largest OD: 3.81 (97) ADBV: Yes Thread Size: 1-12 UNF-2B</p>	<p>LF3316</p>  <p>CASE 675616C91 For Upgrade, use LF3559, LF3919</p> <p>Overall Height: 6.88 (175) Largest OD: 3.78 (96) Standpipe: YES ADBV: Yes Thread Size: 1-12 UNF-2B</p>
<p>LF3308</p>  <p>CASE 538836R1</p> <p>Overall Height: 4.31 (109) Largest OD: 3.73 (95) Thread Size: 5/8-18 UNF-2B</p>	<p>LF3310</p>  <p>OPEL 2866477</p> <p>Overall Height: 3.49 (89) Largest OD: 3.05 (77) Thread Size: 3/4-16 UNF-2B</p>	<p>LF3318</p>  <p>STEIGER 18498</p> <p>Gasket: 332418 Overall Height: 6.71 (170) Largest OD: 5.08 (129) Thread Size: 1 1/2-16 UN-2B</p>
<p>LF3311</p>  <p>ONAN 1220185, WHITE 156513AS</p> <p>Overall Height: 3.75 (95) Largest OD: 3.79 (96) ADBV: Yes BPV Setting: 7.98 (55) Thread Size: 3/4-16 UNF-2B</p>	<p>LF3312</p>  <p>BRIGGS & STRATTON A414</p> <p>Overall Height: 15.75 (400) Overall OD: 6.00 (152) End 1 ID: 2.58 (66)</p>	<p>LF3313</p>  <p>FORD D8PJ6714AA Is a longer version of LF689 For Upgrade, use LF3487</p> <p>Overall Height: 5.32 (135) Largest OD: 3.78 (96) ADBV: Yes BPV Setting: 10.01 (69) Thread Size: 3/4-16 UNF-2B</p>

























E. PRODUCT GUIDE

LF3320  MERCEDES-BENZ 4011840025 Gasket: 3320127 Overall Height: 7.54 (192) Overall OD: 4.74 (121) End 1 ID: 2.21 (56) End 2 ID: 0.54 (14)	LF3330  ISUZU H132011 Overall Height: 4.22 (107) Largest OD: 3.79 (96) ADBV: Yes Thread Size: 3/4-16 UNF-2B	LF3338  BMW 11421250534 Overall Height: 3.48 (88) Largest OD: 3.05 (77) ADBV: Yes BPV Setting: 31.04 (214) Thread Size: 3/4-16 UNF-2B
LF3321  VOLVO 466634, INGERSOLL-RAND 85401909 For Upgrade, use LF9667, LF3379 Overall Height: 10.39 (264) Largest OD: 4.25 (108) Largest OD: 4.26 (108) Thread Size: 1 1/8-16 UN-2B	LF3331  VALMET 836122208 Overall Height: 6.85 (174) Largest OD: 3.68 (94) ADBV: Yes BPV Setting: 17.40 (120) Thread Size: 1-12 UNF-2B	LF3339  FORD E1FZ6731A Overall Height: 4.58 (116) Largest OD: 3.06 (78) ADBV: Yes BPV Setting: 7.98 (55) Thread Size: 3/4-16 UNF-2B
LF3322  MERCEDES-BENZ 11843925 Gasket: 3317145 ¹⁰ Overall Height: 8.98 (228) Overall OD: 4.83 (123) End 1 ID: 1.77 (45)	LF3332  NELSON CP1860T Overall Height: 18.25 (464) Overall OD: 6.75 (171) End 1 ID: 2.62 (67) End 2 ID: 2.50 (64)	LF3340  MERCEDES-BENZ 11843325 Overall Height: 9.39 (239) End 1 OD: 3.97 (101) End 2 OD: 3.95 (100) End 1 ID: 0.54 (14) End 2 ID: 2.27 (58)
LF3323  LEYLAND ACU1608 Overall Height: 6.46 (164) Overall OD: 5.02 (128) End 1 ID: 0.45 (12)	LF3333  AC PF911 For Upgrade, use LF9333, LF3380 Overall Height: 10.32 (262) Largest OD: 4.67 (119) Largest OD: 4.74 (120) Thread Size: 1 1/2-12 UNS-2B	LF3341  KUBOTA 190001206 Overall Height: 4.27 (108) Largest OD: 3.74 (95) ADBV: Yes BPV Setting: 13.49 (93) Thread Size: 3/4-16 UNF-2B
LF3324  ISUZU 132012 Overall Height: 5.69 (145) Largest OD: 3.78 (96) ADBV: Yes Thread Size: 3/4-16 UNF-2B	LF3333SC  GMC 25011106 Overall Height: 6.27 (159) Largest OD: 4.74 (120) Thread Size: 1 1/2-12 UNS-2B	LF3342  CATERPILLAR 8N9586 For Upgrade, use LF3789 Overall Height: 5.42 (138) Largest OD: 3.69 (94) Thread Size: 1 1/8-16 UN-2B
LF3325  CUMMINS 3310169 For Upgrade, use LF9325, LF3363 For Use On Cummins KV16 Engines Overall Height: 11.31 (287) Largest OD: 4.74 (120) Thread Size: 1 1/2-12 UNS-2B	LF3334  NISSAN 15209Y7502 Overall Height: 6.43 (163) Largest OD: 3.31 (84) ADBV: Yes Thread Size: 3/4-16 UNF-2B	LF3343  FORD 826F6714AAA Overall Height: 6.65 (169) Largest OD: 5.47 (139) BPV Setting: 17.40 (120) Thread Size: M60 X 3 - 6H INT
LF3327  MERCEDES-BENZ 11843825, MERCEDES-BENZ 4031840025 Gasket: 3320127, 3320226, 3324572, 3328578 Overall Height: 10.57 (269) Overall OD: 4.74 (121) End 1 ID: 2.21 (56) End 2 ID: 0.54 (14)	LF3335  MOPAR L335 Overall Height: 3.49 (89) Largest OD: 3.05 (77) ADBV: Yes BPV Setting: 12.50 (86) Thread Size: 3/4-16 UNF-2B	LF3344  FORD EJPJ6714AA, CASE 1804442C1 Overall Height: 5.74 (146) Largest OD: 4.24 (108) Thread Size: 1 1/2-16 UN-2B
LF3328  CATERPILLAR 9N6007 For Stratopore version, use LF3968 Overall Height: 6.59 (167) Largest OD: 4.24 (108) Thread Size: 1 1/8-16 UN-2B	LF3337  HONDA 15400689004 Overall Height: 3.09 (78) Largest OD: 3.81 (97) Thread Size: M22 X 1.5-6H INT	LF3345  CUMMINS 3903224, FIAT HITACHI 15183111, FIAT-ALLIS 15183111 For Upgrade, use LF3553 Overall Height: 5.44 (138) Largest OD: 3.69 (94) Thread Size: 1-16 UN-2B

























E. PRODUCT GUIDE

<p>LF3346</p>  <p>IVECO 1901604 For Upgrade, use LF3656</p> <p>Overall Height: 8.11 (206) Largest OD: 4.25 (108) Largest OD: 4.26 (108) Standpipe: YES ADBV: Yes BPV Setting: 23.21 (160) Thread Size: 1-12 UNF-2B</p>	<p>LF3355</p>  <p>MERCEDES-BENZ 3521800109, MERCEDES-BENZ 11845225, MERCEDES-BENZ 11844325, MANN & HUMMEL H942X, KNECHT AF34</p> <p>Gasket: 3320125, 3320127, 3320129 Overall Height: 7.68 (195) Overall OD: 3.29 (84) End 1 ID: 0.97 (25)</p>	<p>LF3363SC</p>  <p>Is a short version of LF3363 Synthetic Media Version of LF670SC</p> <p>Overall Height: 9.81 (249) Largest OD: 4.74 (120) Thread Size: 1 1/2-12 UNS-2B</p>
<p>LF3347</p>  <p>IVECO 1901603</p> <p>Overall Height: 7.31 (186) Largest OD: 4.25 (108) ADBV: Yes BPV Setting: 23.21 (160) Thread Size: 3/4-16 UNF-2B</p>	<p>LF3356</p>  <p>ROLLS ROYCE CV2473</p> <p>Overall Height: 7.34 (187) Largest OD: 4.25 (108) BPV Setting: 23.21 (160) Thread Size: M30 X 1.5-6H INT</p>	<p>LF3364</p>  <p>MERCEDES-BENZ 1800209</p> <p>Gasket: 3321367, 3326790, 3624846 Overall Height: 4.41 (112) Overall OD: 3.86 (98) End 1 ID: 0.51 (13)</p>
<p>LF3348</p>  <p>CHAMP LP2217, LUBERFINER LP2217 M.A.N. 88.05504.0003</p> <p>Overall Height: 9.09 (231) Overall OD: 4.55 (116) End 1 ID: 1.73 (44)</p>	<p>LF3357</p>  <p>LEYLAND 607488, M.A.N. 81055040008</p> <p>Gasket: 3319872 Overall Height: 8.03 (204) Overall OD: 4.27 (109) End 1 ID: 0.51 (13)</p>	<p>LF3365</p>  <p>M.A.N. 51055040062</p> <p>Overall Height: 8.90 (226) Overall OD: 5.06 (129) End 1 ID: 2.21 (56) End 2 ID: 0.54 (14)</p>
<p>LF3349</p>  <p>CUMMINS 3932217 For Upgrade, use LF3552 Has thinner retainer, nut plate and shell than the LF3959 but similar in size.</p> <p>Overall Height: 6.94 (176) Largest OD: 3.69 (94) ADBV: 0.90 (6) Thread Size: 1-16 UN-2B</p>	<p>LF3358</p>  <p>MERCEDES-BENZ 1800109, KHD(KLOCKNER-HUMBOLDT-DEUTZ) 1168465, RENAULT V.I. 944700122</p> <p>Overall Height: 5.12 (130) Overall OD: 4.27 (109) End 1 ID: 0.51 (13)</p>	<p>LF3366</p>  <p>LEYLAND ACU2258</p> <p>Overall Height: 8.68 (221) Overall OD: 4.05 (103) End 1 ID: 1.52 (39)</p>
<p>LF3350</p>  <p>MERCEDES-BENZ 11845625</p> <p>Gasket: 3320127 Overall Height: 9.59 (244) Overall OD: 3.94 (100) End 1 ID: 1.61 (41) End 2 ID: 0.54 (14)</p>	<p>LF3360</p>  <p>FORD E0NN6714AA</p> <p>Overall Height: 6.00 (152) Largest OD: 5.35 (136) ADBV: Yes BPV Setting: 18.00 (124) Thread Size: 1 1/8-16 UN-2B</p>	<p>LF3367</p>  <p>MANN & HUMMEL H20211</p> <p>Overall Height: 7.11 (181) Overall OD: 7.64 (194) End 1 ID: 4.97 (126)</p>
<p>LF3351</p>  <p>RENAULT V.I. 5000242510</p> <p>Overall Height: 7.54 (192) Overall OD: 4.74 (121) End 1 ID: 2.21 (56) End 2 ID: 0.54 (14)</p>	<p>LF3361</p>  <p>THERMO-KING 115522</p> <p>Overall Height: 4.49 (114) Largest OD: 3.31 (84) ADBV: Yes BPV Setting: 7.98 (55) Thread Size: M20 X 1.5-6H INT</p>	<p>LF3368</p>  <p>MANN & HUMMEL H20440</p> <p>Overall Height: 14.29 (363) Overall OD: 7.64 (194) End 1 ID: 4.97 (126) End 2 ID: 4.67 (119)</p>
<p>LF3352</p>  <p>ROLLS ROYCE CD1369</p> <p>Gasket: 3324625, 3324626, 3324656 Overall Height: 10.26 (261) Overall OD: 3.60 (92) End 1 ID: 2.04 (52) End 2 ID: 1.93 (49)</p>	<p>LF3363</p>  <p>Is a longer version of LF3363SC Upgrade of LF3325, LF670 For Upgrade, use LF9325 Synthetic Media Version</p> <p>Overall Height: 11.30 (287) Largest OD: 4.74 (120) Thread Size: 1 1/2-12 UNS-2B</p>	<p>LF3369</p>  <p>FORD E3TZ6731C</p> <p>Overall Height: 5.36 (136) Largest OD: 3.69 (94) ADBV: Yes BPV Setting: 10.01 (69) Thread Size: M20 X 1.5-6H INT</p>
<p>LF3353</p>  <p>FORD D8NN6714GA</p> <p>Overall Height: 4.57 (116) Largest OD: 3.68 (94) ADBV: Yes BPV Setting: 17.40 (120) Thread Size: 3/4-16 UNF-2B</p>	<p>LF3371</p>  <p>FORD E3TZ6731B</p> <p>Overall Height: 3.16 (80) Largest OD: 4.28 (109) Thread Size: M20 X 1.5-6H INT</p>	<p>LF3371</p>  <p>FORD E3TZ6731B</p> <p>Overall Height: 3.16 (80) Largest OD: 4.28 (109) Thread Size: M20 X 1.5-6H INT</p>













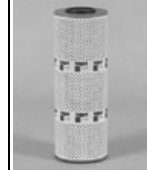









E. PRODUCT GUIDE

LF3372  IVECO 4741272 Overall Height: 5.71 (145) Largest OD: 4.25 (108) Standpipe: YES ADBV: Yes BPV Setting: 29.01 (200) Thread Size: M30 X 2-6H INT	LF3380  Upgrade of LF3333 For Upgrade, use LF9333 Synthetic Media Version Overall Height: 9.82 (249) Largest OD: 4.74 (120) Thread Size: 1 1/2-12 UNS-2B	LF3392  AVELING-BARFORD 9006229 Overall Height: 10.02 (255) Overall OD: 3.60 (92) End 1 ID: 1.97 (50) End 2 ID: 1.93 (49)
LF3373  IVECO 4741273 Overall Height: 7.24 (184) Largest OD: 4.25 (108) Standpipe: YES ADBV: Yes BPV Setting: 23.21 (160) Thread Size: M30 X 2-6H INT	LF3382  CASE 398080R2 Is a longer version of LF3532 Overall Height: 6.88 (175) Largest OD: 3.78 (96) ADBV: Yes BPV Setting: 13.49 (93) Thread Size: 1-12 UNF-2B	LF3393  MERCEDES-BENZ 31841701 Overall Height: 9.09 (231) Largest OD: 4.26 (108) Thread Size: 1-12 UNF-2B
LF3374  Upgrade of LF691 For Upgrade, use LF9691 Synthetic Media Version Overall Height: 11.31 (287) Largest OD: 4.74 (120) Thread Size: 1 1/2-16 UNS-2B	LF3384  NISSAN 1527499329 Gasket: 3830681, 3830682 Overall Height: 6.46 (164) Overall OD: 5.04 (128) End 1 ID: 2.48 (63) End 2 ID: 0.75 (19)	LF3394  HANOMAG-HENSCHEL 5865420000 Gasket: 3321495 Overall Height: 6.46 (164) Overall OD: 5.83 (148) End 1 ID: 3.47 (88) End 2 ID: 88
LF3375  UNITED ENGINE LIFE ELD818B Overall Height: 18.25 (464) Overall OD: 7.25 (184) End 1 ID: 1.00 (25) End 2 ID: 1.06 (27)	LF3386  NISSAN 1527490225 Gasket: 3830685, 3830686, 3830687 Overall Height: 7.59 (193) Overall OD: 3.94 (100) End 1 ID: 1.73 (44) End 2 ID: 0.62 (16)	LF3395  M.A.N. 51055040054 Overall Height: 7.13 (181) Overall OD: 3.78 (96) End 1 ID: 1.16 (30)
LF3376  SCANIA 173171, VOLVO 807180 Overall Height: 3.62 (92) Largest OD: 3.68 (94) ADBV: Yes BPV Setting: 17.40 (120) Thread Size: 3/4-16 UNF-2B	LF3387  MITSUBISHI ME034481 Gasket: 3830637, 3830640 Overall Height: 7.62 (194) Overall OD: 3.93 (100) End 1 ID: 1.13 (29)	LF3397  MERCEDES-BENZ 6171800009, MERCEDES-BENZ 6171800125 Gasket: 3319875, 3321366, 3321367, 3325001 Overall Height: 7.64 (194) End 1 OD: 3.58 (91) End 2 OD: 3.43 (87) End 1 ID: 0.45 (12) End 2 ID: 0.94 (24)
LF3377  CASE 313202R92, CASE 1133277R1 Overall Height: 3.62 (92) Largest OD: 3.68 (94) BPV Setting: 23.21 (160) Thread Size: 3/4-16 UNF-2B	LF3388  HINO 156071030, HINO 6071210440 Overall Height: 6.75 (171) End 1 OD: 4.13 (105) End 2 OD: 4.08 (104) End 1 ID: 1.92 (49) End 2 ID: 0.90 (23)	LF3398  ALLIS-CHALMERS 74037047 Overall Height: 7.22 (183) Largest OD: 4.24 (108) Thread Size: 1-16 UN-2B
LF3378  ZETTELMEYER 2138220, RENAULT V.I. 7701008698 Overall Height: 3.62 (92) Largest OD: 3.68 (94) ADBV: Yes BPV Setting: 36.26 (250) Thread Size: 3/4-16 UNF-2B	LF3390  CASE 995285C1 Overall Height: 4.31 (109) Largest OD: 3.73 (95) BPV Setting: 7.98 (55) Thread Size: 13/16-16 UNS-2B	LF3399  TOYOTA 1560168010 Overall Height: 5.72 (145) Largest OD: 4.24 (108) BPV Setting: 32.49 (224) Thread Size: M30 X 1.5-6H INT
LF3379  VERMEER 102379001 Upgrade of LF3321, LF667 For Upgrade, use LF9667 Synthetic Media Version Overall Height: 10.39 (264) Largest OD: 4.24 (108) Thread Size: 1 1/8-16 UN-2B	LF3391  MERCEDES-BENZ 1846725 Overall Height: 8.03 (204) Overall OD: 4.27 (109) End 1 ID: 0.51 (13)	LF3400  KHD(KLOCKNER-HUMBOLDT-DEUTZ) 3357461 Overall Height: 3.62 (92) Largest OD: 3.68 (94) ADBV: Yes BPV Setting: 9.43 (65) Thread Size: 3/4-16 UNF-2B



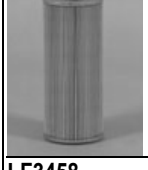





















E. PRODUCT GUIDE

<p>LF3401 LEYLAND BBU2994</p>  <p>Overall Height: 5.59 (142) Largest OD: 3.68 (94) ADBV: Yes BPV Setting: 9.43 (65) Thread Size: 3/4-16 UNF-2B</p>	<p>LF3413 FRAM P7549 For Upgrade, use LF3687 Renault 50 00 670 670</p>  <p>Overall Height: 8.31 (211) Largest OD: 3.68 (94) ADBV: Yes BPV Setting: 36.26 (250) Thread Size: 1-12 UNF-2B</p>	<p>LF3424 ISUZU 1878100510</p>  <p>Gasket: 3830625, 3830626, 3830627, 3830628 Overall Height: 6.77 (172) End 1 OD: 4.45 (113) End 2 OD: 4.07 (103) End 1 ID: 0.59 (15)</p>
<p>LF3402 MANN & HUMMEL W940, AC PF32</p>  <p>Overall Height: 5.59 (142) Largest OD: 3.68 (94) ADBV: Yes BPV Setting: 36.26 (250) Thread Size: 3/4-16 UNF-2B</p>	<p>LF3414 FAIREY ARLON 5611F185</p>  <p>Gasket: 3321788, 3321789, 3321790 Overall Height: 11.42 (290) Overall OD: 4.96 (126) End 1 ID: 3.62 (92) End 2 ID: 0.55 (14)</p>	<p>LF3425 ISUZU 1878100791</p>  <p>Gasket: 3830627, 3830634, 3830637, 3831234 Overall Height: 9.35 (237) End 1 OD: 4.44 (113) End 2 OD: 4.08 (104) End 1 ID: 0.59 (15)</p>
<p>LF3403 KUBOTA 7000015241, INGERSOLL-RAND 54477096</p>  <p>Gasket: 330818 Overall Height: 2.55 (65) Largest OD: 3.05 (77) ADBV: Yes BPV Setting: 7.98 (55) Thread Size: M20 X 1.5-6H INT</p>	<p>LF3415 KOMATSU 6002116240</p>  <p>Overall Height: 3.41 (87) Largest OD: 3.72 (94) BPV Setting: 28.57 (197) Thread Size: 1-12 UNF-2B</p>	<p>LF3428 ISUZU 9885111940</p>  <p>Gasket: 3830629, 3830630, 3830631, 3830632, 3830648 Overall Height: 5.77 (147) Overall OD: 3.28 (83) End 1 ID: 0.63 (16) End 2 ID: 1.62 (41)</p>
<p>LF3405 KOMATSU 6134515120</p>  <p>Overall Height: 6.63 (168) Largest OD: 4.24 (108) ADBV: Yes BPV Setting: 27.99 (193) Thread Size: 1 1/8-16 UN-2B</p>	<p>LF3417 KOMATSU 6002116140</p>  <p>Overall Height: 3.85 (98) Largest OD: 3.72 (94) ADBV: Yes BPV Setting: 35.53 (245) Thread Size: 1-12 UNF-2B</p>	<p>LF3430 ISUZU 9885132630</p>  <p>Gasket: 3830627, 3830634, 3830636, 3830637 Overall Height: 4.17 (106) Overall OD: 4.10 (104) End 1 ID: 1.97 (50)</p>
<p>LF3406 NISSAN 1527499186, CHAMP 1627094, CHAMP LFP5963</p>  <p>Overall Height: 8.06 (205) Largest OD: 4.26 (108) Thread Size: 1 1/8-16 UN-2B</p>	<p>LF3420 CASE 1808896C1 For Upgrade, use LF3560</p>  <p>Overall Height: 8.06 (205) Largest OD: 3.78 (96) Standpipe: YES ADBV: Yes Thread Size: 1-12 UNF-2B</p>	<p>LF3431 ISUZU 9885132641</p>  <p>Gasket: 3830627, 3830634, 3830636, 3830637 Overall Height: 7.49 (190) End 1 OD: 4.16 (106) End 2 OD: 4.08 (104) End 1 ID: 0.59 (15)</p>
<p>LF3407 ISUZU 5132110180, GMC 94028863</p>  <p>Overall Height: 4.61 (117) Largest OD: 4.24 (108) ADBV: Yes BPV Setting: 19.58 (135) Thread Size: M20 X 1.5-6H INT</p>	<p>LF3421 CASE 1808946C1</p>  <p>Overall Height: 8.10 (206) Largest OD: 3.69 (94) Thread Size: 1-12 UNF-2B</p>	<p>LF3432 MITSUBISHI 3124053015</p>  <p>Gasket: 3830637 (2), 3830681(2) Overall Height: 6.66 (169) Overall OD: 5.12 (130) End 1 ID: 0.60 (15)</p>
<p>LF3409 Cummins 3910125</p>  <p>Overall Height: 4.58 (116) Largest OD: 3.05 (77) BPV Setting: 19.58 (135) Thread Size: 3/4-16 UNF-2B</p>	<p>LF3422 HITACHI 4505384</p>  <p>Gasket: 3830627, 3830634, 3830637, 3830679 Overall Height: 9.57 (243) Overall OD: 4.12 (105) End 1 ID: 1.95 (50)</p>	<p>LF3433 MITSUBISHI ME014833</p>  <p>Overall Height: 5.35 (136) Largest OD: 3.69 (94) ADBV: Yes BPV Setting: 19.00 (131) Thread Size: M20x1.5-6H</p>
<p>LF3410 VOLVO 4713921</p>  <p>Overall Height: 11.31 (287) Largest OD: 4.74 (120) Thread Size: 1 3/8-16 UNS-2B</p>	<p>LF3423 HITACHI 4507886</p>  <p>Gasket: 3830637, 3830645 Overall Height: 5.78 (147) Overall OD: 4.09 (104) End 1 ID: 0.59 (15)</p>	<p>LF3434 NISSAN 15208H8911</p>  <p>Overall Height: 4.02 (102) Largest OD: 3.31 (84) ADBV: Yes Thread Size: 3/4-16 UNF-2B</p>



















E. PRODUCT GUIDE

LF3435  NISSAN 15208W1111 Overall Height: 3.82 (97) Largest OD: 3.82 (97) ADBV: Yes Thread Size: 3/4-16 UN-2B	LF3447  MITSUBISHI 3124053054 Gasket: 3830637, 3830681 Overall Height: 5.87 (149) Overall OD: 5.04 (128) End 1 ID: 2.28 (58)	LF3459  MITSUBISHI ME064289 Gasket: 3830637, 3830638 Overall Height: 12.90 (328) Overall OD: 4.56 (116) End 1 ID: 2.07 (53)
LF3436  NISSAN 15208Z9001 Overall Height: 8.02 (204) Largest OD: 4.27 (108) Thread Size: 1 1/8-16 UN-2B	LF3448  DOUGLAS F. L. HD3 Overall Height: 2.56 (65) Largest OD: 3.05 (77) ADBV: Yes BPV Setting: 7.98 (55) Thread Size: M16 X 1.5-6H INT	LF3460  LISTER PETTER 20155370 Overall Height: 3.09 (79) Largest OD: 3.11 (79) ADBV: Yes BPV Setting: 14.50 (100) Thread Size: 3/4-16 UNF-2B
LF3438  NISSAN 15274Z9029 Gasket: 3830637, 3831236, 3831244 Overall Height: 5.74 (146) Overall OD: 3.90 (99) End 1 ID: 0.66 (17)	LF3449  HANOMAG-HENSCHEL 114932108 Overall Height: 5.59 (142) Largest OD: 3.68 (94) ADBV: Yes BPV Setting: 36.26 (250) Thread Size: 3/4-16 UNF-2B	LF3462  KUBOTA 1524132092 Overall Height: 3.19 (81) Largest OD: 3.31 (84) ADBV: Yes BPV Setting: 7.98 (55) Thread Size: M20 X 1.5-6H INT
LF3441  NISSAN 1527499428 Gasket: 3830639, 3830641, 3830651, 3830680 Overall Height: 5.90 (150) Overall OD: 3.80 (97) End 1 ID: 0.59 (15)	LF3451  V.A.G. (VOLKSWAGEN, AUDI) 68115561B Overall Height: 5.59 (142) Largest OD: 3.68 (94) ADBV: Yes BPV Setting: 36.26 (250) Thread Size: 3/4-16 UNF-2B	LF3463  PURFLUX L135 Gasket: 3322250, 3322251 Overall Height: 8.27 (210) Overall OD: 4.33 (110) End 1 ID: 0.79 (20)
LF3443  FORD E7HZ6731A Overall Height: 7.22 (183) Largest OD: 4.24 (108) BPV Setting: 19.58 (135) Thread Size: 1-12 UNF-2B	LF3453  Upgrade of LF747 For Upgrade, use LF9747 Stratapore Media Version Of LF747. Overall Height: 11.31 (287) Largest OD: 4.74 (120) Thread Size: 1 1/2-12 UNS-2B	LF3464  VOLVO 471034 Overall Height: 5.34 (136) Largest OD: 4.25 (108) ADBV: Yes BPV Setting: 23.21 (160) Thread Size: 1-12 UNF-2B
LF3443SC  Short Version Of LF3443 Overall Height: 5.77 (146) Largest OD: 4.24 (108) BPV Setting: 19.58 (135) Thread Size: 1-12 UNF-2B	LF3455  CASE 1811953C1 Overall Height: 8.11 (206) Largest OD: 4.26 (108) Thread Size: 1-12 UNF-2B	LF3466  VOLVO 4804651 Overall Height: 5.59 (142) Largest OD: 3.68 (94) ADBV: Yes BPV Setting: 23.21 (160) Thread Size: 3/4-16 UNF-2B
LF3444  FIAT-ALLIS 74744707 Overall Height: 9.07 (230) Largest OD: 4.28 (109) ADBV: Yes BPV Setting: 19.58 (135) Thread Size: M30 X 2-6H INT	LF3457  MITSUBISHI ME021254 Gasket: 3830637, 3830640 Overall Height: 9.17 (233) Overall OD: 3.94 (100) End 1 ID: 1.22 (31)	LF3467  VALMET 7836436346 Overall Height: 5.59 (142) Largest OD: 3.68 (94) ADBV: Yes BPV Setting: 36.26 (250) Thread Size: M24 X 1.5-6H INT
LF3446  HINO 156071010 Gasket: 3830631, 3830637, 3831239, 3831240, 3831244 Overall Height: 8.62 (219) Overall OD: 4.78 (121) End 1 ID: 0.91 (23)	LF3458  MITSUBISHI ME034161 Gasket: 3830637, 3830640 Overall Height: 7.91 (201) Overall OD: 3.98 (101) End 1 ID: 1.21 (31)	LF3468  VALMET 7836136342 Overall Height: 6.85 (174) Largest OD: 3.68 (94) ADBV: Yes BPV Setting: 36.26 (250) Thread Size: M24 X 1.5-6H INT

























E. PRODUCT GUIDE

LF3472 LEYLAND HAJ8423  Overall Height: 8.26 (210) Largest OD: 5.38 (137) Thread Size: 1 1/2-16 UNS-2B	LF3483 SAME 5215650  Overall Height: 8.98 (228) Largest OD: 4.25 (108) ADBV: Yes BPV Setting: 23.21 (160) Thread Size: 3/4-16 UNF-2B	LF3494 AMERICAN MOTORS 8983501900  Overall Height: 3.19 (81) Largest OD: 3.68 (93) BPV Setting: 13.49 (93) Thread Size: M20 X 1.5-6H INT
LF3473 ONAN 1220550  Overall Height: 5.42 (138) Largest OD: 3.69 (94) BPV Setting: 22.04 (152) Thread Size: M22 X 1.5-6H INT	LF3484 RENAULT V.I. 4000151830  Overall Height: 7.34 (187) Largest OD: 4.33 (110) ADBV: Yes BPV Setting: 17.40 (120) Thread Size: 1 1/8-16 UN-2B	LF3495 TOYOTA 1560113011  Overall Height: 3.22 (82) Largest OD: 3.31 (84) ADBV: Yes BPV Setting: 12.47 (86) Thread Size: 3/4-16 UNF-2B
LF3475 MANN & HUMMEL H930  Overall Height: 9.09 (231) Overall OD: 3.19 (81) End 1 ID: 0.51 (13)	LF3485 CATERPILLAR 7N7500 Uses service part: 3940105S  Gasket: 3940105S Overall Height: 10.29 (261) Overall OD: 7.39 (188) End 1 ID: 2.85 (72)	LF3497 FORD E7NN6714CA  Overall Height: 5.22 (133) Largest OD: 4.26 (108) ADBV: Yes BPV Setting: 19.58 (135) Thread Size: 1-12 UNF-2B
LF3476 GARDNER H27096  Overall Height: 10.26 (261) Largest OD: 4.33 (110) Thread Size: 1 1/8-16 UN-2B	LF3487 Upgrade of LF3313, LF551A Synthetic Media Version of LF551A and LF3313  Overall Height: 5.40 (137) Largest OD: 3.78 (96) ADBV: Yes BPV Setting: 10.01 (69) Thread Size: 3/4-16 UNF-2B	LF3498 NISSAN 1527499025  Overall Height: 8.34 (212) Overall OD: 4.43 (113) End 1 ID: 0.63 (16)
LF3477 RENAULT V.I. 5000670700 Is a longer version of LF3565  Overall Height: 10.30 (262) Largest OD: 4.33 (110) Thread Size: 1 1/8-16 UN-2B	LF3488 DONALDSON P166564, DONALDSON P168687 Upgrade of LF651, LF653 Synthetic Media Version  Overall Height: 5.41 (137) Largest OD: 3.69 (94) Thread Size: 13/16-16 UNS-2B	LF3499 KUBOTA 1521332090  Overall Height: 4.48 (114) Largest OD: 3.28 (83) BPV Setting: 17.50 (121) Thread Size: 3/4-16 UNF-2B
LF3478 HINO 156071381  Overall Height: 8.09 (205) Largest OD: 4.74 (120) Thread Size: 1 1/2-12 UNF-2B	LF3489 SAME 41553001  Overall Height: 5.71 (145) Largest OD: 4.25 (108) ADBV: Yes BPV Setting: 23.21 (160) Thread Size: 3/4-16 UNF-2B	LF3501 MOTORCRAFT FL300  Overall Height: 4.22 (107) Largest OD: 3.80 (97) ADBV: Yes BPV Setting: 12.47 (86) Thread Size: 3/4-16 UNF-2B
LF3479 WHITE 303068145  Overall Height: 8.06 (205) Largest OD: 4.24 (108) ADBV: Yes BPV Setting: 19.58 (135) Thread Size: 7/8-16 UN-2B	LF3490 KUBOTA 1542632430  Overall Height: 4.48 (114) Largest OD: 3.28 (83) ADBV: Yes BPV Setting: 19.58 (135) Thread Size: 3/4-16 UNF-2B	LF3504 ISUZU 1878103340, GMC 94038680  Gasket: G223 Overall Height: 8.90 (226) Overall OD: 6.50 (165) End 1 ID: 0.04 (1) Thread Size: 3/8-24 UN-2B
LF3481 IVECO 1902076 Combo style filter  Overall Height: 5.71 (145) Largest OD: 4.25 (108) ADBV: Yes BPV Setting: 23.21 (160) Thread Size: 3/4-16 UNF-2B	LF3493 DAF 267714 Is a longer version of LF3606 For Upgrade, use LF3765  Overall Height: 12.43 (316) Largest OD: 5.38 (137) BPV Setting: 36.26 (250) Thread Size: 1 1/2-16 UNS-2B	LF3505 FORD E4NN6714BA  Overall Height: 5.40 (137) Largest OD: 3.81 (97) Standpipe: YES ADBV: Yes BPV Setting: 22.02 (152) Thread Size: 3/4-16 UNF-2B

E. PRODUCT GUIDE

LF3506  M.A.N. 51055017165, M.A.N. 51055017160 Overall Height: 7.34 (187) Largest OD: 4.33 (110) BPV Setting: 23.21 (160) Thread Size: M30 X 2-6H INT	LF3516  ISUZU 1878100501 Gasket: 3834594 (2), 3834599(2), 3834611 Overall Height: 13.00 (330) Overall OD: 6.50 (165) End 1 ID: 0.58 (15) End 2 ID: 0.80 (20)	LF3525  ONAN 122060201 Overall Height: 4.58 (116) Largest OD: 3.05 (77) BPV Setting: 17.40 (120) Thread Size: M22 X 1.5-6H INT
LF3507  VOLVO 3823531 Gasket: 3322917 Overall Height: 2.05 (52) Overall OD: 2.44 (62) End 1 ID: 1.00 (26)	LF3517  HINO 156071320 Overall Height: 6.79 (172) Overall OD: 4.14 (105) End 1 ID: 0.57 (14) End 2 ID: 1.92 (49)	LF3528  ISUZU X132010140 Gasket: 3903730 Overall Height: 4.15 (105) Largest OD: 3.69 (94) BPV Setting: 19.50 (135) Thread Size: M20 X 1.5-6H INT
LF3508  ISUZU 8941432050 Overall Height: 5.18 (132) Largest OD: 4.52 (115) Thread Size: 1-12 UNF	LF3518  ISUZU 5132400370 Gasket: 3834596, 3834600, 3834610, 3834613 Overall Height: 2.88 (73) Overall OD: 3.91 (99) End 1 ID: 0.67 (17)	LF3530  CASE A146696 Overall Height: 5.69 (145) Largest OD: 3.78 (96) ADBV: Yes BPV Setting: 11.02 (76) Thread Size: 3/4-16 UNF-2B
LF3509  MASSEY-FERGUSON 3283341M1 Overall Height: 3.19 (81) Largest OD: 3.31 (84) ADBV: Yes BPV Setting: 17.40 (120) Thread Size: 3/4-16 UNF-2B	LF3519  ISUZU 1132400560 Gasket: 3834594 (2), 3834595(2), 3834614 Overall Height: 12.95 (329) Overall OD: 6.50 (165) End 1 ID: 1.57 (40) Thread Size: M16x1-6H	LF3532  IHC 3136046R93 Is a short version of LF3382 Overall Height: 4.28 (109) Largest OD: 3.73 (95) BPV Setting: 22.04 (152) Thread Size: 1-12 UNF-2B
LF3511  HINO 156071100 Gasket: 3834593, 3834597 Overall Height: 7.38 (187) Overall OD: 4.09 (104) End 1 ID: 0.59 (15)	LF3521  M.A.N. 81055040023, RENAULT V.I. 5000275939 Uses service part: 3322951S Gasket: 3322951 ¹⁰ Overall Height: 4.61 (117) Overall OD: 3.78 (96) End 1 ID: 1.16 (30)	LF3534  GMC 25012306 Overall Height: 2.75 (70) Overall OD: 2.91 (74) End 1 ID: 0.69 (18)
LF3513  HINO 156071390 Gasket: 3834597, 3834603 Overall Height: 4.82 (122) Overall OD: 3.78 (96) End 1 ID: 0.87 (22)	LF3522  ISUZU 8941145840 Overall Height: 3.82 (97) Largest OD: 3.33 (85) Thread Size: M22x1.5-6H	LF3536  YANMAR 11900535100, YANMAR YM11900535100 for Fluted shell version see LF16157 Overall Height: 4.02 (102) Largest OD: 3.31 (84) ADBV: Yes BPV Setting: 7.98 (55) Thread Size: M20 X 1.5-6H INT
LF3514  MITSUBISHI ME034605 Gasket: 3834597, 3834616 Overall Height: 7.66 (195) Overall OD: 4.33 (110) End 1 ID: 0.75 (19)	LF3523  ISUZU 8941145850 Overall Height: 3.32 (84) Largest OD: 4.15 (105) Thread Size: M20 X 1.5 - 6H U	LF3537  MITSUBISHI MD135737 Overall Height: 3.19 (81) Largest OD: 3.31 (84) ADBV: Yes BPV Setting: 11.02 (76) Thread Size: M20 X 1.5-6H INT
LF3515  ISUZU 1878102390 Gasket: 3834594 (2), 3834595(2), 3834614 Overall Height: 11.00 (279) Overall OD: 6.50 (165) End 1 ID: 1.63 (41) Thread Size: M16 X 1-6H INT	LF3524  MITSUBISHI ME014838 Overall Height: 3.88 (99) Largest OD: 3.68 (93) Thread Size: M18 X 1.5-6H INT	LF3538  Upgrade of LF581 Overall Height: 5.32 (135) Largest OD: 3.78 (96) ADBV: Yes Thread Size: 13/16-16 UNS-2B

























E. PRODUCT GUIDE

LF3541  HINO 156071750 Overall Height: 8.27 (210) Largest OD: 4.74 (120) Thread Size: 1 1/2-12 UNF-2B	LF3549  DOUGLAS F. L. HD2 Overall Height: 4.58 (116) Largest OD: 3.05 (77) ADBV: Yes BPV Setting: 17.41 (120) Thread Size: 3/4-16 UNF-2B	LF3560  Upgrade of LF3420 Overall Height: 8.06 (205) Largest OD: 3.78 (96) Standpipe: YES Thread Size: 1-12 UNF-2B
LF3542  HINO 156071760 Overall Height: 9.81 (249) Largest OD: 4.74 (120) Thread Size: 1 3/8-16 UNS-2B	LF3550  ISUZU X13201009 Overall Height: 3.99 (101) Largest OD: 3.31 (84) ADBV: Yes BPV Setting: 13.49 (93) Thread Size: 3/4-16 UNF-2B	LF3563  ISUZU 1132400890, HINO 156071471 Overall Height: 5.74 (146) Largest OD: 4.24 (108) Thread Size: 5/8-18 UNF-2B
LF3543  GMC 94360419 Largest OD: 4.02 (102) Largest OD: 4.10 (104) Thread Size: 5/8-18 UNF-2B	LF3551  KOMATSU 6128515030 Gasket: 3303380, 3837721 Overall Height: 15.08 (383) Overall OD: 6.31 (160) End 1 ID: 0.87 (22)	LF3564  MITSUBISHI MD069782 Combo style filter Overall Height: 5.63 (143) Largest OD: 4.41 (112) BPV Setting: 14.50 (100) Thread Size: M26 X 1.5-6H INT
LF3544  ISUZU X13201013 Overall Height: 9.81 (249) Largest OD: 4.74 (120) Thread Size: 1 3/8-16 UNS-2B	LF3552  CUMMINS 3155618 Upgrade of LF3349 Overall Height: 6.94 (176) Largest OD: 3.69 (94) Thread Size: 1-16 UN-2B	LF3565  RENAULT V.I. 5010240400 is a short version of LF3477 Overall Height: 7.34 (187) Largest OD: 4.33 (110) Thread Size: 1 1/8-16 UN-2B
LF3545  ISUZU X13201011	LF3553  DONALDSON ELF7345 Upgrade of LF3345 Overall Height: 5.44 (138) Largest OD: 3.69 (94) Thread Size: 1-16 UN-2B	LF3566  Upgrade of LF691A For Upgrade, use LF9691A Overall Height: 12.20 (310) Largest OD: 5.38 (137) Thread Size: 1 1/16-16 UN-2B
LF3546  ISUZU X13201012 Overall Height: 6.59 (167) Largest OD: 4.27 (108) Thread Size: M20 X 1.5-6H INT	LF3554  Upgrade of LF782 Overall Height: 4.57 (116) Largest OD: 3.05 (77) ADBV: Yes Thread Size: M18 X 1.5-6H INT	LF3567  JOHN DEERE RE57394 Gasket: 329753 Overall Height: 6.69 (170) Largest OD: 5.08 (129) Thread Size: 1 1/2-12 UNF-2B
LF3547  ISUZU 1132004872 Overall Height: 6.59 (167) Largest OD: 4.27 (108) Thread Size: 1 1/8-16 UN-2B	LF3555  ONAN 1220764 Overall Height: 4.57 (116) Largest OD: 3.05 (77) Thread Size: 3/4-16 UNF-2B	LF3568  ATLAS COPCO 1202849700, KHD(KLOCKNER-HUMBOLDT-DEUTZ) 1172346, BOMAG 5710632 Overall Height: 4.75 (121) Largest OD: 2.96 (75) ADBV: Yes Thread Size: 3/4-16 UNS-2B
LF3548  CASE J919562, CUMMINS 3919562 For Upgrade, use LF9548 Combo style filter Overall Height: 9.36 (238) Largest OD: 4.68 (119) Thread Size: 2 1/4-12 UNS-2B	LF3559  Upgrade of LF3316 For Upgrade, use LF3919 Overall Height: 6.88 (175) Largest OD: 3.78 (96) Standpipe: YES ADBV: Yes Thread Size: 1-12 UNF-2B	LF3570  PEGASO 649092, MANN & HUMMEL W11681 Overall Height: 7.34 (187) Largest OD: 4.33 (110) ADBV: Yes BPV Setting: 23.21 (160) Thread Size: 1 1/8-16 UN-2B

E. PRODUCT GUIDE

LF3571  NISSAN FL20901D20 Overall Height: 7.90 (201) Largest OD: 3.72 (94) Thread Size: 1-12 UNF-2B	LF3586  MITSUBISHI ME074013, MITSUBISHI ME130968 Overall Height: 8.66 (220) Largest OD: 5.11 (130) Thread Size: M36 - P1.5	LF3598  M.A.N. 51.05504.0087 Gasket: 3324572 Overall Height: 10.57 (269) Overall OD: 4.74 (121) End 1 ID: 2.21 (56) End 2 ID: 0.54 (14)
LF3572  IVECO 1902093 Bypass filter Overall Height: 9.05 (230) Largest OD: 4.27 (108) Thread Size: M22 X 1.5-6H INT	LF3587  MITSUBISHI ME088519 Overall Height: 6.37 (162) Largest OD: 4.53 (115) Thread Size: 1 1/8-16 UNF-2B	LF3599  NISSAN 1520910H00 Overall Height: 4.74 (120) Largest OD: 3.00 (76) ADBV: Yes Thread Size: 3/4-16 UNS-2B
LF3573  MERCEDES-BENZ 3661840125, MERCEDES- BENZ 3661800310 Gasket package attached. Gasket: 3320125, 3320127, 3320129 Overall Height: 7.68 (195) Overall OD: 3.28 (83) End 1 ID: 0.93 (24)	LF3588  MITSUBISHI ME034878 Overall Height: 6.39 (162) Largest OD: 4.41 (112) Thread Size: 1 1/8-16 UNF-2B	LF3603  HITACHI 4266385 Overall Height: 9.78 (248) Largest OD: 4.66 (118) Thread Size: 1 3/8-16 UN-2B
LF3574  CASE H436531 Overall Height: 2.75 (70) Largest OD: 3.79 (96) ADBV: Yes BPV Setting: 22.04 (152) Thread Size: 3/4-16 UNF-2B	LF3591  KUBOTA 1584132430, KUBOTA 1584132431 Overall Height: 2.84 (72) Largest OD: 3.31 (84) BPV Setting: 12.47 (86) Thread Size: M20 X 1.5-6H INT	LF3604  CHRYSLER 5281090 Overall Height: 3.20 (81) Largest OD: 3.61 (92) Thread Size: 3/4-16 UNS-2B
LF3580  V.A.G. (VOLKSWAGEN, AUDI) 45115581A Overall Height: 7.10 (180) Largest OD: 3.68 (94) ADBV: Yes BPV Setting: 36.26 (250) Thread Size: 3/4-16 UNF-2B	LF3593  VOLVO 8477416 Overall Height: 7.10 (180) Largest OD: 4.24 (108) Thread Size: 1 1/8-16 UN-2B	LF3605  MERCEDES-BENZ 3661840225 Gasket: 3320125, 3320127, 3320129 Overall Height: 5.24 (133) Overall OD: 3.28 (83) End 1 ID: 0.93 (24)
LF3583  IVECO 1907583, TECNOCAR RD3004 Combo type filter Overall Height: 7.33 (186) Largest OD: 4.25 (108) ADBV: Yes BPV Setting: 23.21 (160) Thread Size: 3/4-16 UNF-2B	LF3594  IVECO 1907584, TECNOCAR RD3005 Combo type filter Overall Height: 8.41 (214) Largest OD: 4.25 (108) ADBV: Yes BPV Setting: 23.21 (160) Thread Size: M30 X 2-6H INT	LF3606  DAF 267715 Is a short version of LF3493 Gasket: 3836569, 3843259 Overall Height: 10.00 (254) Largest OD: 5.38 (137) BPV Setting: 36.26 (250) Thread Size: 1 1/2-16 UNS-2B
LF3584  MERCEDES-BENZ 6011800109 Gasket: 3326468, 3326469, 3326470 Overall Height: 6.61 (168) End 1 OD: 3.58 (91) End 2 OD: 3.43 (87) End 1 ID: 0.45 (12) End 2 ID: 0.94 (24)	LF3595  IVECO 1905704, TECNOCAR RD3002 Combo type filter Overall Height: 10.22 (260) Largest OD: 4.25 (108) ADBV: Yes BPV Setting: 23.21 (160) Thread Size: M30 X 2-6H INT	LF3607  MANN & HUMMEL H9471Z Uses service part: 3917215S Gasket package attached. Gasket: 3326916 (2), 3326917 Overall Height: 7.68 (195) Overall OD: 3.28 (83) End 1 ID: 0.93 (24)
LF3585  MERCEDES-BENZ 6161800009 Gasket: 3325295, 3326467, 3326469 Overall Height: 7.48 (190) End 1 OD: 3.58 (91) End 2 OD: 3.43 (87) End 1 ID: 0.45 (12) End 2 ID: 0.94 (24)	LF3596  GENERAL ELECTRIC 2X4222, UNITED ENGINE LIFE P22 Overall Height: 29.38 (746) Overall OD: 6.40 (163) End 1 ID: 1.46 (37)	LF3608  TOYOTA 9091503006 Combo type filter Height: 4.84 (123) End 1 OD: 4.13 (105)

E. PRODUCT GUIDE

<p>LF3610 CATERPILLAR 1R0659</p>  <p>Overall Height: 9.25 (235) Height: 9.28 (236) Overall OD: 4.00 (102) End 1 OD: 3.99 (101) End 1 ID: 1.64 (42)</p>	<p>LF3625 Same as LF4054 with a removal nut welded on shell</p>  <p>Overall Height: 8.52 (216) Largest OD: 3.68 (94) ADBV: Yes BPV Setting: 36.26 (250) Thread Size: 1-12 UNF-2B</p>	<p>LF3634 SUNNEN PF110</p>  <p>Overall Height: 14.60 (371) Overall OD: 5.83 (148) End 1 ID: 0.99 (25)</p>
<p>LF3614 TOYOTA 9091503001</p>  <p>Overall Height: 2.90 (74) Largest OD: 2.67 (68) Thread Size: 3/4-16 UNS-2B</p>	<p>LF3626 HITACHI 4206089</p>  <p>Overall Height: 7.97 (202) Largest OD: 4.65 (118) Thread Size: 1 1/2-12 UNF-2B</p>	<p>LF3635 This filter is a pleated paper by-pass filter. To meet Cummins specifications, use LF777.</p>  <p>Overall Height: 11.31 (287) Largest OD: 4.74 (120) Thread Size: 1 3/8-16 UNS-2B</p>
<p>LF3615 TOYOTA 9091503004</p>  <p>Overall Height: 3.46 (88) Largest OD: 2.69 (68) ADBV: Yes BPV Setting: 17.40 (120) Thread Size: 3/4-16 UNS-2B</p>	<p>LF3627 HITACHI 4208241</p>  <p>Overall Height: 8.13 (207) Overall OD: 6.50 (165) End 1 ID: 1.69 (43) Thread Size: M16x1-6H</p>	<p>LF3637 DAEWOO 65055105009</p>  <p>Overall Height: 6.94 (176) Largest OD: 3.69 (94) Thread Size: 1-16 UN-2B</p>
<p>LF3618 HINO 156071600</p>  <p>Overall Height: 7.83 (199) Largest OD: 4.53 (115) Thread Size: 1 1/2-16 UNF-2B</p>	<p>LF3628 HITACHI 4231195</p>  <p>Overall Height: 6.58 (167) Overall OD: 6.50 (165) End 1 ID: 0.58 (15) End 2 ID: 0.07 (2)</p>	<p>LF3638 NISSAN FL20805D01</p>  <p>Overall Height: 5.01 (127) Largest OD: 3.72 (94) ADBV: Yes Thread Size: 3/4-16 UNF-2B</p>
<p>LF3620 GMC 25014505 For Upgrade, use LF3671, LF9620 Cellulose Full Flow</p>  <p>Overall Height: 9.82 (249) Largest OD: 4.74 (120) Thread Size: 1 5/8-12 UNS-2B</p>	<p>LF3629 NISSAN 1527499289</p>  <p>Overall Height: 9.57 (243) Overall OD: 5.12 (130) End 1 ID: 1.10 (28)</p>	<p>LF3639 Does not meet OE specifications</p>  <p>Overall Height: 11.88 (302) Largest OD: 4.68 (119) Thread Size: 2 1/4-12 UNS-2B</p>
<p>LF3622 ISUZU 8970492820 Is a longer version of LF3622SC</p>  <p>Overall Height: 8.13 (207) Largest OD: 4.73 (120) Thread Size: 1 1/2-12 UNS-2B</p>	<p>LF3630 CASE 1814562C1 For Stratapore version, use LF3974</p>  <p>Overall Height: 8.12 (206) Largest OD: 4.27 (108) Thread Size: 1 1/2-16 UN-2B</p>	<p>LF3641 THERMO-KING 116228 By-pass filter</p>  <p>Overall Height: 5.59 (142) Largest OD: 3.68 (94) Thread Size: 3/4-20 UNEF-2B</p>
<p>LF3622SC ISUZU 8970492820 Is a short version of LF3622</p>  <p>Overall Height: 6.11 (155) Largest OD: 4.67 (119) Thread Size: 1 1/2 - 12 UNF 2B</p>	<p>LF3632 LEYLAND 8G2300</p>  <p>Overall Height: 4.29 (109) Overall OD: 2.80 (71) End 1 ID: 1.30 (33)</p>	<p>LF3642 HITACHI 4183853, ISUZU 8941609641</p>  <p>Overall Height: 5.73 (146) Largest OD: 4.33 (110) ADBV: Yes BPV Setting: 17.40 (120) Thread Size: 1-12 UNF-2B</p>
<p>LF3624 PEUGEOT 110986, MANN & HUMMEL W815, PURFLUX LS468A, CROSLAND 2031</p>  <p>Overall Height: 3.52 (90) Largest OD: 3.07 (78) ADBV: Yes BPV Setting: 21.75 (150) Thread Size: M20 X 1.5-6H INT</p>	<p>LF3633 KOMATSU Z1402OF105, DONALDSON P551264, KOMATSU Z148970246070</p>  <p>Overall Height: 5.69 (145) Largest OD: 4.27 (108) ADBV: Yes BPV Setting: 20.01 (138) Thread Size: M20 X 1.5-6H INT</p>	<p>LF3643 LEYLAND AAR5607, PERKINS 2654409</p>  <p>Overall Height: 3.62 (92) Largest OD: 3.68 (94) ADBV: Yes BPV Setting: 17.40 (120) Thread Size: 13/16-16 UN-2B</p>

E. PRODUCT GUIDE

LF3644 ISUZU 8943687270, HITACHI 4294841



Overall Height: 3.41 (87)
Largest OD: 2.70 (69)
ADBV: Yes
BPV Setting: 14.50 (100)
Thread Size: M20 X 1.5-6H INT

LF3645 WAUKESHA 167602B



Overall Height: 15.62 (397)
Overall OD: 4.38 (111)
End 1 ID: 1.38 (35)
End 2 ID: 1.00 (25)

LF3646 INGERSOLL-RAND 58966706



Overall Height: 3.08 (78)
Largest OD: 3.13 (79)
ADBV: Yes
BPV Setting: 11.02 (76)
Thread Size: M20x1.5-6H

LF3647 PURFLUX LS520C, MANN & HUMMEL W840 Leyland, Daf 192143, Purflux LS520C, Mann W840



Overall Height: 5.59 (142)
Largest OD: 3.54 (90)
ADBV: Yes
BPV Setting: 23.21 (160)
Thread Size: M20 X 1.5-6H INT

LF3649 AC X88, ISUZU 93156093



Gasket: 330818
Overall Height: 3.49 (89)
Largest OD: 3.03 (77)
ADBV: Yes
BPV Setting: 12.47 (86)
Thread Size: M20 X 1.5-6H INT

LF3650 NISSAN FL62290004



Overall Height: 5.77 (147)
Largest OD: 3.72 (94)
ADBV: Yes
BPV Setting: 12.47 (86)
Thread Size: 1-12 UNF-2B

LF3651 NISSAN FL201Z9010



Overall Height: 6.61 (168)
Largest OD: 4.28 (109)
Thread Size: 1 1/8-16 UN-2B

LF3652 NISSAN FL201Z9011



Overall Height: 6.66 (169)
Largest OD: 4.27 (108)
Thread Size: 3/4-16 UNF-2B

LF3653 MITSUBISHI 3444022100



Overall Height: 4.57 (116)
Largest OD: 3.68 (94)
ADBV: Yes
BPV Setting: 23.21 (160)
Thread Size: 1-12 UNF-2B

LF3654 VOLVO 477556



Overall Height: 10.39 (264)
Largest OD: 4.24 (108)
Thread Size: 1 3/8-16 UN-2B

LF3655 FORD 914F6714AA, MOTORCRAFT EFL386, FORD FINISCODE 6203126



Overall Height: 3.68 (94)
Largest OD: 3.78 (96)
ADBV: Yes
BPV Setting: 14.50 (100)
Thread Size: M22 X 1.5-6H INT

LF3656 Upgrade of LF3346



Overall Height: 8.11 (206)
Largest OD: 4.26 (108)
ADBV: Yes
BPV Setting: 19.87 (137)
Thread Size: 1-12 UNF-2B

LF3657 MAZDA RF0123802A



Overall Height: 3.04 (77)
Largest OD: 3.15 (80)
ADBV: Yes
BPV Setting: 17.40 (120)
Thread Size: M20 X 1.5-6H INT

LF3658 Liaz Engines



Overall Height: 9.00 (229)
Largest OD: 4.33 (110)
ADBV: Yes
BPV Setting: 36.26 (250)
Thread Size: 1 1/8-16 UN-2B

LF3659 NISSAN 15208W1120



Overall Height: 4.57 (116)
Largest OD: 3.68 (94)
ADBV: Yes
Thread Size: 3/4-16 UNF-2B

LF3660 CATERPILLAR 1W4136



Overall Height: 13.60 (345)
Overall OD: 7.31 (186)
End 1 ID: 3.41 (87)

LF3661 VALMET 836336459



Overall Height: 10.26 (261)
Largest OD: 4.33 (110)
BPV Setting: 23.21 (160)
Thread Size: M30 X 1.5-6H INT

LF3664 KOMATSU 6136515120



Overall Height: 6.63 (168)
Largest OD: 4.26 (108)
BPV Setting: 27.99 (193)
Thread Size: 1 1/8-16 UN-2B

LF3665 MAZDA SL0223802



Overall Height: 5.93 (151)
Largest OD: 4.19 (106)
Thread Size: 1-12 UNF-2B

LF3666 MAZDA 130523802



Overall Height: 6.89 (175)
Largest OD: 4.19 (106)
ADBV: Yes
Thread Size: 1-12 UN-2B

LF3669 MAZDA SL5114V61



Overall Height: 4.92 (125)
Largest OD: 3.66 (93)
Thread Size: M20x1.5-6H

LF3671 Upgrade of LF3620 For Upgrade, use LF9620 Stratapore Full Flow



Overall Height: 9.82 (249)
Largest OD: 4.74 (120)
Thread Size: 1 5/8-12 UNS-2B

LF3675 VOLVO 478736, VOLVO 4787362





















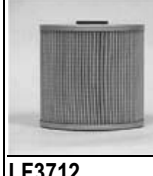

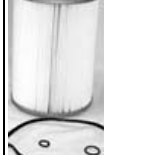

Overall Height: 10.39 (264)
Largest OD: 4.33 (110)
Thread Size: 1 1/8-16 UN-2B

LF3678 LOMBARDINI 270217528, SLANZI 4002175090























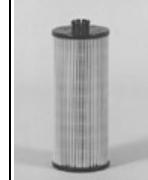



Overall Height: 2.91 (74)
Largest OD: 3.07 (78)
ADBV: Yes
BPV Setting: 11.60 (80)
Thread Size: M14 X 1.5-6H INT

E. PRODUCT GUIDE

<p>LF3679 GMC 25013977, AC PF1218</p>  <p>Overall Height: 5.12 (130) Largest OD: 3.67 (93) ADBV: Yes Thread Size: 13/16-16 UNS-2B</p>	<p>LF3688 MITSUBISHI 3134012030</p>  <p>Overall Height: 4.33 (110) Overall OD: 3.62 (92) End 1 ID: 0.69 (18)</p>	<p>LF3708 KOMATSU 20M01R2251</p>  <p>Overall Height: 3.99 (101) Largest OD: 3.31 (84) ADBV: Yes BPV Setting: 17.40 (120) Thread Size: 3/4-16 UNF-2B</p>
<p>LF3681 FORD F1AZ6731A, MOTORCRAFT FL820 For Upgrade, use LF16002</p>  <p>Overall Height: 3.85 (98) Largest OD: 3.69 (94) ADBV: Yes BPV Setting: 7.98 (55) Thread Size: M22 X 1.5-6H</p>	<p>LF3689 HINO 156071480</p>  <p>Overall Height: 5.91 (150) Largest OD: 4.13 (105) Thread Size: M26x1.5</p>	<p>LF3709 HINO 156071341, GENERAC CORP. 590890102</p>  <p>Overall Height: 9.75 (248) Overall OD: 4.80 (122) End 1 ID: 0.69 (18)</p>
<p>LF3682 HITACHI 4366703</p>  <p>Overall Height: 3.40 (86) Largest OD: 3.68 (93) ADBV: Yes BPV Setting: 12.47 (86) Thread Size: 3/4-16 UNF-2B</p>	<p>LF3690 SUZUKI 1651073002</p>  <p>Overall Height: 2.98 (76) Largest OD: 3.31 (84) ADBV: Yes BPV Setting: 14.00 (97) Thread Size: 3/4-16 UNF-2B</p>	<p>LF3710 ISUZU 1878103720</p>  <p>Overall Height: 4.09 (104) Overall OD: 4.09 (104) End 1 ID: 0.59 (15)</p>
<p>LF3683 CATERPILLAR 2S9969</p>  <p>Overall Height: 5.77 (147) Largest OD: 3.69 (94) BPV Setting: 17.40 (120) Thread Size: 7/8-14 UNF-2B</p>	<p>LF3691 MAZDA JEYO14302</p>  <p>Overall Height: 3.35 (85) Largest OD: 2.81 (71) ADBV: Yes BPV Setting: 10.00 (69) Thread Size: M20x1.5-6H</p>	<p>LF3712 ISUZU 113241170</p> 
<p>LF3684 NISSAN FL201Z9009, NISSAN 15201Z9009 is a longer version of LF3884</p>  <p>Overall Height: 9.81 (249) Largest OD: 4.74 (120) Thread Size: M36 X 1.5-7H INT</p>	<p>LF3692 MAZDA B6Y114302</p>  <p>Overall Height: 2.58 (65) Largest OD: 2.69 (68) BPV Setting: 8.00 (55) Thread Size: 20X1.5 MM</p>	<p>LF3713 DAEWOO 65055105015</p>  <p>Overall Height: 6.94 (176) Largest OD: 3.69 (94) ADBV: Yes Thread Size: 1-16 UN-2B</p>
<p>LF3685 Synthetic Media Version of LF551A & LF3313 with a standpipe</p>  <p>Overall Height: 5.40 (137) Largest OD: 3.78 (96) Standpipe: YES ADBV: Yes BPV Setting: 10.01 (69) Thread Size: 3/4-16 UNF-2B</p>	<p>LF3703 JOHN DEERE RE59754, RENAULT 6005021346, ALASKA DIESEL 2401002, JOHN DEERE RE59574 Uses service part: 3958392S</p>  <p>Overall Height: 5.76 (146) Largest OD: 3.77 (96) BPV Setting: 22.04 (152) Thread Size: 1 1/2-16 UN-2B</p>	<p>LF3714 RENAULT V.I. 7700073302</p>  <p>Overall Height: 3.62 (92) Largest OD: 3.68 (94) ADBV: Yes BPV Setting: 17.40 (120) Thread Size: M20 X 1.5-6H INT</p>
<p>LF3686 HINO 156071351</p>  <p>Overall Height: 8.66 (220) Overall OD: 4.80 (122) End 1 ID: 0.69 (18)</p>	<p>LF3706 KUBOTA 1732132430, CASE 126385A1</p>  <p>Overall Height: 3.40 (86) Largest OD: 3.68 (93) ADBV: Yes BPV Setting: 12.47 (86) Thread Size: 3/4-16 UNF-2B</p>	<p>LF3715 DAEWOO 65055105016</p>  <p>Overall Height: 8.09 (205) Largest OD: 4.74 (120) ADBV: Yes Thread Size: 1 1/2-12 UNS-2B</p>
<p>LF3687 Upgrade of LF3413, LF4054 Microglass Version</p>  <p>Overall Height: 8.31 (211) Largest OD: 3.68 (94) ADBV: Yes BPV Setting: 36.26 (250) Thread Size: 1-12 UNF-2B</p>	<p>LF3707 CASE 1959198C1</p>  <p>Overall Height: 3.19 (81) Largest OD: 3.31 (84) ADBV: Yes BPV Setting: 7.98 (55) Thread Size: M20 X 1.5-6H INT</p>	<p>LF3716 DAEWOO 65055105017</p>  <p>Overall Height: 9.81 (249) Largest OD: 4.74 (120) ADBV: Yes Thread Size: 1 1/2-12 UNS-2B</p>

E. PRODUCT GUIDE

LF3726  SUNNEN PF104 Not available in all parts of the world. Overall Height: 14.60 (371) Overall OD: 5.83 (148) End 1 ID: 0.99 (25)	LF3745  MP PRODUCTS 100855 Overall Height: 3.49 (89) Largest OD: 3.05 (77) Thread Size: 3/4-16 UNF-2B	LF3769  MERCEDES-BENZ 6061840125 Overall Height: 6.89 (175) Overall OD: 3.23 (82) End 1 ID: 1.42 (36)
LF3727  DAF 1306878 Overall Height: 12.01 (305) Largest OD: 4.68 (119) Standpipe: YES Thread Size: 2 1/4-12 UNS-2B	LF3746  For Upgrade, use LF3918 Overall Height: 6.94 (176) Largest OD: 3.69 (94) Thread Size: M26 X 1.5-6H INT	LF3770  V.A.G. (VOLKSWAGEN, AUDI) 69115561 Overall Height: 4.51 (115) Largest OD: 4.25 (108) ADBV: Yes BPV Setting: 36.26 (250) Thread Size: 3/4-16 UNF-2B
LF3728  VICKERS V0191AB1R03 Overall Height: 5.40 (137) Largest OD: 3.78 (96) ADBV: Yes BPV Setting: 10.01 (69) Thread Size: 3/4-16 UNF-2B	LF3749  LIEBHERR 7381111 Overall Height: 9.00 (229) Largest OD: 4.33 (110) ADBV: Yes BPV Setting: 36.26 (250) Thread Size: M30 X 2-6H INT	LF3773  DAF 1327672 Upgrade of LF3737 Overall Height: 12.43 (316) Largest OD: 5.41 (137) BPV Setting: 36.26 (250) Thread Size: M42X2-6H INT
LF3730  SCANIA 1347726 Uses service part: 3931308S Overall Height: 10.24 (260) Largest OD: 4.33 (110) Thread Size: 1 1/8-16 UN-2B	LF3752  GEHL 127389 Overall Height: 5.70 (145) Largest OD: 4.24 (108) Thread Size: 1-12 UNF-2B	LF3775  CLAAS 1334960 Overall Height: 5.08 (129) Overall OD: 4.27 (109) End 1 ID: 0.51 (13)
LF3733  CATERPILLAR 9T9054 Overall Height: 8.19 (208) Overall OD: 3.03 (77) End 1 ID: 1.08 (28)	LF3754  M.A.N. 51055040096 Overall Height: 8.35 (212) End 1 OD: 3.33 (85) End 2 OD: 3.31 (84) End 2 ID: 1.56 (40)	LF3776  TRANSICOLD 251503800, CARRIER 251503800 Overall Height: 3.99 (101) Largest OD: 3.31 (84) ADBV: Yes BPV Setting: 7.98 (55) Thread Size: M20 X 1.5-6H INT
LF3737  DAF 1310901 For Upgrade, use LF3773 Overall Height: 12.43 (316) Largest OD: 5.41 (137) BPV Setting: 36.26 (250) Thread Size: M42 X 2-6H INT	LF3758  VOLVO 35178573 Overall Height: 3.23 (82) Largest OD: 3.68 (94) ADBV: Yes BPV Setting: 17.40 (120) Thread Size: 3/4-16 UNF-2B	LF3778  LISTER PETER 75110620 Overall Height: 2.34 (60) Largest OD: 3.78 (96) ADBV: Yes BPV Setting: 17.40 (120) Thread Size: 3/4-16 UNF-2B
LF3740  YANMAR 11959335100 Overall Height: 8.75 (222) Largest OD: 3.73 (95) BPV Setting: 20.16 (139) Thread Size: 1-12 UNF-2B	LF3764  CHERY 481H1012010 LF3765  Upgrade of LF3493 Overall Height: 12.43 (316) Largest OD: 5.38 (137) BPV Setting: 36.26 (250) Thread Size: 1 1/2-16 UNS-2B	LF3781  GMC 23550401 For Upgrade, use LF3931, LF9931 Overall Height: 12.20 (310) Largest OD: 5.38 (137) Thread Size: M45 X 1.5-6H INT
LF3744  LIEBHERR 5700043 Overall Height: 8.31 (211) Largest OD: 3.68 (94) ADBV: Yes BPV Setting: 36.26 (250) Thread Size: 1-12 UNF-2B	LF3766  KHD(KLOCKNER-HUMBOLDT-DEUTZ) 1174416, FIAT-ALLIS 76562846, DEUTZ AG 1174416 Overall Height: 3.48 (88) Largest OD: 3.06 (78) ADBV: Yes BPV Setting: 34.95 (241) Thread Size: 3/4-16 UNF-2B	LF3783  VALMET 836647133 Overall Height: 5.68 (144) Largest OD: 4.25 (108) ADBV: Yes BPV Setting: 36.26 (250) Thread Size: M24 X 1.5-6H INT

E. PRODUCT GUIDE

LF3786 ISUZU 8970497081



Overall Height: 4.06 (103)
Largest OD: 3.70 (94)
BPV Setting: 15.00 (103)
Thread Size: M20 X 1.5 INT

LF3788 MASSEY-FERGUSON
1088209M91 Upgrade of
LF654



Overall Height: 5.42 (138)
Largest OD: 3.69 (94)
BPV Setting: 22.04 (152)
Thread Size: 1-12 UNF-2B

LF3789 GMC 25011153 Upgrade of
LF3342



Overall Height: 5.42 (138)
Largest OD: 3.69 (94)
Thread Size: 1 1/8-16 UN-2B

LF3790 DAF 1306549



Overall Height: 8.96 (228)
Largest OD: 4.23 (108)
BPV Setting: 36.26 (250)
Thread Size: 1-12 UNF-2B

LF3792 LINDE 9830608



Overall Height: 5.59 (142)
Largest OD: 3.68 (94)
ADB: Yes
BPV Setting: 36.26 (250)
Thread Size: 3/4-16 UNF-2B

LF3794 HATZ 1480000



Overall Height: 2.56 (65)
Overall OD: 1.65 (42)
BPV Setting: 36.26 (250)
End 1 ID: 0.55 (14)

LF3795 NEW HOLLAND 86546618,
CASE 86402050



Overall Height: 3.79 (96)
Largest OD: 3.81 (97)
ADB: Yes
BPV Setting: 22.04 (152)
Thread Size: 3/4-16 UNF-2B

LF3797 PURFLUX L182



Overall Height: 11.79 (299)
Overall OD: 5.71 (145)
End 1 ID: 2.24 (57)

LF3801 ISUZU 1132401160



Overall Height: 7.36 (187)
End 1 OD: 4.09 (104)
End 2 OD: 4.08 (104)
End 1 ID: 1.93 (49)
End 2 ID: 0.59 (15)

LF3805 CASE J934429



Overall Height: 5.44 (138)
Largest OD: 3.69 (94)
Thread Size: 1-16 UN-2B

LF3806 CASE J934430 Stratapore



Overall Height: 6.94 (176)
Largest OD: 3.69 (94)
Thread Size: 1-16 UN-2B

LF3807 ISUZU 2906548000 Isuzu
Applications



LF3808 MANN & HUMMEL W11408



Overall Height: 5.69 (145)
Largest OD: 4.33 (110)
ADB: Yes
BPV Setting: 23.21 (160)
Thread Size: 1-12 UNF-2B

LF3811 ISUZU 8941674001



Overall Height: 4.80 (122)
Overall OD: 3.31 (84)
End 1 ID: 1.06 (27)

LF3812 NEW HOLLAND 73185316,
MITSUBISHI MD162326



Overall Height: 4.06 (103)
Largest OD: 3.19 (81)
BPV Setting: 23.00 (159)
Thread Size: M20 X 1.5

LF3813 LF4072 + gasket 3625120S



Gasket: 3625120S
Overall Height: 7.64 (194)
Overall OD: 3.82 (97)
End 1 ID: 1.18 (30)

LF3815 MITSUBISHI ME084641



Overall Height: 5.35 (136)
Overall OD: 3.70 (94)
End 1 ID: 1.10 (28)

LF3816 ISUZU 1878103132



Overall Height: 9.25 (235)
Overall OD: 5.04 (128)
End 1 ID: 2.48 (63)

LF3817 MITSUBISHI ME088532



Overall Height: 7.13 (181)
Largest OD: 4.44 (113)
Thread Size: M26x1.5-6H

LF3818 HINO 156072050, HINO
15672051, HINO 156072170
Replaces 156072051



Overall Height: 8.09 (205)
Largest OD: 4.74 (120)
Thread Size: 1 1/2-16 UNS-2B

LF3819 KHD(KLOCKNER-
HUMBOLDT-DEUTZ) 4208014



Overall Height: 5.93 (151)
End 1 OD: 3.33 (85)
End 2 OD: 3.31 (84)
End 2 ID: 1.56 (40)

LF3822 HITACHI 4225367



Overall Height: 11.93 (303)
Overall OD: 6.50 (165)
End 1 ID: 0.58 (15)
Thread Size: M16 X P2.0

LF3823 HITACHI 4095346



Overall Height: 6.22 (158)
Overall OD: 5.51 (140)
End 1 ID: 0.47 (12)

LF3824 DAF 1338179



Overall Height: 9.00 (229)
Largest OD: 4.33 (110)
BPV Setting: 36.26 (250)
Thread Size: M30 X 2-6H INT

LF3825 DAF 1346986



Overall Height: 8.86 (225)
Largest OD: 5.39 (137)
Thread Size: 1 1/2-16 UNS-2B

LF3826 FARYMANN 5410272



Overall Height: 2.40 (61)
Largest OD: 3.15 (80)
ADB: Yes
BPV Setting: 14.50 (100)
Thread Size: 3/4-16 UNF-2B

LF3827 MERCEDES-BENZ
A0001801609





























Overall Height: 5.91 (150)
Overall OD: 3.31 (84)
End 1 ID: 1.56 (40)

LF3828 MITSUBISHI 32A4000100



Overall Height: 4.04 (103)
Largest OD: 4.33 (110)
ADB: Yes
BPV Setting: 23.21 (160)
Thread Size: 1-12 UNF-2B

E. PRODUCT GUIDE

LF3829  MERCEDES-BENZ 541180009 Overall Height: 12.36 (314) End 1 OD: 4.78 (122) End 2 OD: 4.76 (121) End 2 ID: 2.22 (57)	LF3861  NEW HOLLAND 86605897 Overall Height: 6.90 (175) Largest OD: 3.71 (94) ADBV: Yes BPV Setting: 20.16 (139) Thread Size: 1-12 UNF-2B	LF3874  TOYOTA 9091520001 Overall Height: 3.31 (84) Largest OD: 2.91 (74) BPV Setting: 14.00 (97) Thread Size: 3/4 X 16
LF3830  MITSUBISHI ME013343 Overall Height: 5.98 (152) Largest OD: 4.28 (109) Thread Size: M26X1.5-6H	LF3862  HINO 156071920 Overall Height: 3.32 (84) Largest OD: 2.79 (71) Thread Size: M20 X 1.5	LF3882  IKARUS ATM35 Overall Height: 7.13 (181) Largest OD: 5.08 (129) Thread Size: M16 X 1.5-6H INT
LF3837  ISUZU 5873105030 Overall Height: 7.94 (202) Largest OD: 4.33 (110) Largest OD: 4.41 (112) Thread Size: M20 X 1.5-6H INT	LF3863  NISSAN 1520840L02 Overall Height: 5.15 (131) Largest OD: 3.78 (96) Thread Size: 1	LF3883  INTERNATIONAL TRUCKS 1833121C1 Overall Height: 12.19 (310) Largest OD: 5.41 (137) BPV Setting: 27.99 (193) Thread Size: M36 X 1.5-5H
LF3843  DAF 1345332 Overall Height: 8.74 (222) Largest OD: 5.39 (137) Thread Size: M42 X 2-6H	LF3864  IVECO 8014680 Overall Height: 7.31 (186) Largest OD: 4.25 (108) ADBV: Yes BPV Setting: 36.26 (250) Thread Size: 1-12 UNF-2B	LF3884  NISSAN FL201Z9009A Is a short version of LF3684 Overall Height: 8.13 (207) Largest OD: 4.73 (120) Thread Size: M36 X 1.5-7H INT
LF3848  KHD(KLOCKNER-HUMBOLDT-DEUTZ) 1180815 Overall Height: 2.50 (64) Largest OD: 3.07 (78) ADBV: Yes BPV Setting: 36.26 (250) Thread Size: 3/4-16 UNF-2B	LF3867  M.A.N. 51055040098 Overall Height: 5.79 (147) Overall OD: 4.80 (122) End 1 ID: 2.19 (56)	LF3893  FIAT-ALLIS 8806171 European Market Applications only Overall Height: 7.80 (198) Overall OD: 3.74 (95) End 1 ID: 1.30 (33)
LF3849  TOYOTA 9091530001	LF3868  HINO 156071270 Overall Height: 5.60 (142) Largest OD: 3.92 (100)	LF3894  Upgrade of LF3959 Overall Height: 6.93 (176) Largest OD: 3.68 (93) Thread Size: 1-16 UN-2B
LF3850  ISUZU 8943910490 Overall Height: 8.27 (210) Largest OD: 4.92 (125) Thread Size: 1 1/2-12 UNF-2B	LF3871  MITSUBISHI MACAIR1 Overall Height: 3.32 (84) Largest OD: 3.76 (96) Thread Size: M20 X 1.5	LF3896  HITACHI 4304883 Overall Height: 11.97 (304) Overall OD: 6.31 (160)
LF3854  ISUZU 8943381811 Overall Height: 4.75 (121) Largest OD: 4.90 (124) Thread Size: 1 1/2 - 12 UNF-2B	LF3872  TOYOTA 415246011	LF3912  MITSUBISHI FP100036 Overall Height: 5.00 (127) Largest OD: 3.72 (94) ADBV: Yes BPV Setting: 12.50 (86) Thread Size: 3/4-16 UNF-2B
LF3857  ISUZU 8943604271 Overall Height: 4.98 (126) Largest OD: 4.19 (106) Thread Size: M26x1.5-6H	LF3873  TOYOTA 415231011 Overall Height: 4.28 (109) Largest OD: 2.79 (71)	LF3914  MERCEDES-BENZ 1801709 Overall Height: 8.37 (213) Overall OD: 3.31 (84) End 1 ID: 1.56 (40)

E. PRODUCT GUIDE

LF3915 CUMMINS 3938015,
KOMATSU 6732515141



Overall Height: 5.81 (148)
Largest OD: 3.69 (94)
ADBV: Yes
Thread Size: 1-16 UN-2B

LF3918 THERMO-KING 117382
Upgrade of LF3746



Overall Height: 6.92 (176)
Largest OD: 3.66 (93)
Thread Size: M26 X 1.5

LF3919 CASE 373568A1 Upgrade of
LF3316, LF3559



Overall Height: 6.95 (177)
Largest OD: 3.68 (93)
Standpipe: YES
ADBV: Yes
Thread Size: 1-12 UNF-2B

LF3921 KOMATSU 6736515140



Overall Height: 6.90 (175)
Largest OD: 3.69 (94)
Thread Size: 1-16 UN-2B

LF3922 KOMATSU 6733515140



Overall Height: 5.40 (137)
Largest OD: 3.69 (94)
Thread Size: 1-16 UN-2B

LF3925 KUBOTA 1585399170



Overall Height: 2.76 (70)
Largest OD: 2.68 (68)
ADBV: Yes
BPV Setting: 36.26 (250)
Thread Size: M20 X 1.5-6H INT

LF3931 GMC 23550401 Upgrade of
LF3781 For Upgrade, use
LF9931 Stratapore Media



Overall Height: 12.20 (310)
Largest OD: 5.38 (137)
Thread Size: M45 X 1.5 - 6H

LF3932 NISSAN 1520929D00,
NISSAN FL20929D00



Overall Height: 7.96 (202)
Largest OD: 3.68 (93)
Thread Size: 1-12 UNF-2B

LF3933 NISSAN 1520829D00,
NISSAN FL20829D00



Overall Height: 3.89 (99)
Largest OD: 3.70 (94)
ADBV: Yes
Thread Size: 3/4-16 UNF-2B

LF3934 KOMATSU 6736515141



Overall Height: 6.94 (176)
Largest OD: 3.69 (94)
ADBV: Yes
Thread Size: 1-16 UN-2B

LF3936 CASE 381457A1,
INGERSOLL-RAND 54429675



Overall Height: 2.87 (73)
Largest OD: 3.31 (84)
BPV Setting: 12.47 (86)
Thread Size: M20 X 1.5-6H INT

LF3940 IVECO 2992188



Overall Height: 5.55 (141)
Largest OD: 3.68 (94)
ADBV: Yes
BPV Setting: 9.43 (65)
Thread Size: M22 X 1.5-6H INT

LF3941 JOHN DEERE RE506178
Uses service part: 3958392S



Overall Height: 5.79 (147)
Largest OD: 3.77 (96)
BPV Setting: 22.04 (152)
Thread Size: 1 1/2-16 UN-2B

LF3945 GMC 25014377 For Upgrade,
use LF16104 various light
truck and auto with Vortex
engines Product is not
available in all regions of the
world.



Overall Height: 4.12 (105)
Largest OD: 3.05 (77)
ADBV: Yes
Thread Size: 13/16-16 UNS-2B

LF3947 CARRIER 300045000,
TRANSICOLD 300045000

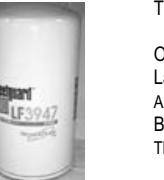

Overall Height: 6.95 (177)
Largest OD: 3.68 (93)
ADBV: Yes
BPV Setting: 10.00 (69)
Thread Size: 3/4-16 UNF-2B

LF3957 DETROIT DIESEL 23526919



Overall Height: 12.20 (310)
Largest OD: 5.38 (137)
BPV Setting: 36.00 (248)
Thread Size: 1 1/2-16 UNS-2B

LF3959 CHRYSLER 5016547AC,
CUMMINS 3937695,
CUMMINS 3937743 For
Upgrade, use LF3894
Designed for ISB, 5.9L, 24
Valve Engines. Has thicker
nut plate, shell and retainer
than LF3349



Overall Height: 6.94 (176)
Largest OD: 3.68 (93)
Thread Size: 1-16 UN-2B

LF3960 YALE & TOWNE 150017600



Overall Height: 3.40 (86)
Largest OD: 2.92 (74)
Thread Size: 3/4-16 UNF-2B

LF3963 UNITED ENGINE LIFE
EW1645C2, WAUKESHA
168660



Overall Height: 31.00 (787)
Overall OD: 4.38 (111)
End 1 ID: 1.59 (40)

LF3964 QUINCY 110814, QUINCY
110814001



Overall Height: 3.35 (85)
Largest OD: 2.92 (74)
BPV Setting: 8.00 (55)
Thread Size: 16 X 1.5 MM

LF3968 Stratapore version of LF3328



Overall Height: 6.59 (167)
Largest OD: 4.24 (108)
Thread Size: 1 1/8-16 UN-2B

LF3970 CUMMINS 3937736 Uses
service part: 3907721S
Stratapore Media



Overall Height: 6.96 (177)
Largest OD: 3.68 (93)
Thread Size: 1 1/8-16 UN-2B

LF3972 CHRYSLER 5083285AA,
CUMMINS 3949561 For
Upgrade, use LF16035



Overall Height: 6.96 (177)
Largest OD: 3.68 (93)
Thread Size: 1-16 UN-2B

LF3973 MACK 485GB3232



Overall Height: 10.39 (264)
Largest OD: 4.24 (108)
Thread Size: 1 1/8-16 UN-2B

LF3974 Stratapore version of LF3630



Overall Height: 8.12 (206)
Largest OD: 4.27 (108)
Thread Size: 1 1/2-16 UN-2B

LF3976 Cummins Japan Applications



Overall Height: 11.31 (287)
Largest OD: 4.74 (120)
Thread Size: 1 1/2-12 UNS-2B

LF3977 IVECO 99445200



Overall Height: 8.43 (214)
Largest OD: 4.33 (110)
Thread Size: M30 X 2-6H INT

E. PRODUCT GUIDE

LF3983 INGERSOLL-RAND 54381314



Overall Height: 4.15 (105)
Largest OD: 3.69 (94)
BPV Setting: 12.50 (86)
Thread Size: M20 X 1.5-6H INT

LF3989 CUMMINS 3424714



Overall Height: 7.95 (202)
Overall OD: 7.64 (194)
End 1 ID: 4.67 (119)

LF3990 CUMMINS 3424713



Overall Height: 15.61 (397)
Overall OD: 7.64 (194)
End 1 ID: 4.67 (119)

LF3994 THERMO-KING 119101



Overall Height: 7.14 (181)
Largest OD: 4.24 (108)
Thread Size: 3/4-20 UNEF-2B

LF3995 HITACHI 4285642



Overall Height: 7.95 (202)
Largest OD: 4.33 (110)
Thread Size: M20X1.5-6H

LF3996 GENERAC CORP. 52241



Overall Height: 3.22 (82)
Largest OD: 3.31 (84)
ADBV: Yes
BPV Setting: 7.98 (55)
Thread Size: M20 X 1.5-6H INT

LF3997 MERCEDES-BENZ 6111800009



Overall Height: 4.65 (118)
Overall OD: 2.56 (65)
End 1 ID: 1.22 (31)

LF3998 MANN & HUMMEL H9324N, MERCEDES-BENZ 3661800609 Uses service part: 3329992S



Gasket: 3328578, 3329993, 3329994
Overall Height: 5.24 (133)
Overall OD: 3.28 (83)
End 1 ID: 0.93 (24)

LF3999 MERCEDES-BENZ 3661800709, MANN & HUMMEL H9471N Uses service part: 3329992S



Gasket: 3328578, 3329993, 3329994
Overall Height: 7.68 (195)
Overall OD: 3.28 (83)
End 1 ID: 0.93 (24)

LF4001 LEYLAND 129925



Gasket: 3324577
Overall Height: 2.82 (72)
Overall OD: 3.52 (89)
End 1 ID: 1.33 (34)

LF4002 GARDNER LW6252



Gasket: GP4418
Overall Height: 8.54 (217)
End 1 OD: 3.17 (81)
End 2 OD: 2.70 (69)
End 1 ID: 0.77 (20)
End 2 ID: 0.43 (11)

LF4003 LEYLAND 3H2689, LEYLAND 11K243, CUMMINS 700778, BRITISH LEYLAND 244433

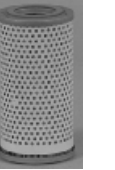

Gasket: 3324576, 3324625, 3324626
Overall Height: 7.01 (178)
Overall OD: 3.60 (92)
End 1 ID: 1.97 (50)
End 2 ID: 1.93 (49)

LF4005 LEYLAND 602426



Gasket: GP4402, GP4412, GP4415
Overall Height: 9.37 (238)
Overall OD: 3.10 (79)
End 1 ID: 0.47 (12)
End 2 ID: 0.75 (19)

LF4007 LEYLAND 801779



Gasket: 3320544, 3320977, 3328351
Overall Height: 5.08 (129)
Overall OD: 4.05 (103)
End 1 ID: 1.52 (39)

LF4014 OPEL 650352, GMC 6438162



Gasket: GP4407
Overall Height: 3.39 (86)
Largest OD: 3.07 (78)
Thread Size: 3/4-16 UNF-2B

LF4016 FORD 692M6714AA



Gasket: GP4404
Overall Height: 4.57 (116)
Largest OD: 3.68 (94)
Standpipe: Yes
ADBV: Yes
BPV Setting: 17.40 (120)
Thread Size: 3/4-16 UNF-2B

LF4017 VOLVO 423135, GENERAL ELECTRIC DAV111



Overall Height: 6.85 (174)
Largest OD: 3.68 (94)
BPV Setting: 17.40 (120)
Thread Size: 1-12 UNF-2B

LF4031 CHRYSLER K29769



Gasket: 3324577
Overall Height: 5.91 (150)
Overall OD: 3.68 (94)
End 1 ID: 1.32 (34)

LF4032 ROLLS ROYCE OE12448



Gasket: 3321718, 3324577, GP4417
Overall Height: 5.65 (144)
Overall OD: 3.62 (92)
End 1 ID: 1.30 (33)
End 2 ID: 0.51 (13)

LF4045 EMD/GENERAL MOTORS 8345482



Overall Height: 29.38 (746)
Overall OD: 6.50 (165)
End 1 ID: 1.47 (37)

LF4053 M.A.N. 81055040041 Uses service part: 3320226, 3324572



Gasket: 3320127, 3320226, 3324572, 3328578
Overall Height: 10.57 (269)
Overall OD: 4.74 (121)
End 1 ID: 2.21 (56)
End 2 ID: 0.54 (14)

LF4054 MANN & HUMMEL W962 For Upgrade, use LF3687 For removal nut see LF3625



Overall Height: 8.27 (210)
Largest OD: 3.68 (94)
ADBV: Yes
BPV Setting: 36.26 (250)
Thread Size: 1-12 UNF-2B

LF4056 DEUTZ AG 1173481, KHD(KLOCKNER-HUMBOLDT-DEUTZ) 363031















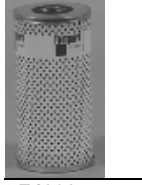









Overall Height: 5.59 (142)
Largest OD: 3.68 (94)
ADBV: Yes
BPV Setting: 36.26 (250)
Thread Size: 1-12 UNF-2B

LF4071 MANN & HUMMEL H10501, DAF 213342







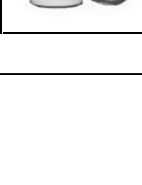





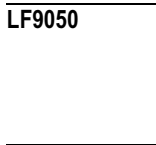













Gasket: 3309762
Overall Height: 6.45 (164)
Overall OD: 3.82 (97)
End 1 ID: 1.19 (30)

E. PRODUCT GUIDE

<p>LF4072</p>  <p>MANN & HUMMEL H1060, DAF 248126 Uses service part: 3625120S</p> <p>Gasket: 3309762 Overall Height: 7.65 (194) Overall OD: 3.82 (97) End 1 ID: 1.19 (30)</p>	<p>LF4126</p>  <p>FORD 105E6731</p> <p>Overall Height: 3.19 (81) Overall OD: 2.84 (72) End 1 ID: 0.82 (21)</p>	<p>LF9018</p>  <p>KOMATSU 6002111340</p> <p>Overall Height: 12.99 (330) Largest OD: 4.68 (119) Thread Size: M95 X 2.5-7H INT</p>
<p>LF4081</p>  <p>FIAT-ALLIS 8806171 In Europe use gasket 3327543</p> <p>Gasket: 3301610 Overall Height: 7.77 (197) Overall OD: 3.83 (97) End 1 ID: 1.33 (34)</p>	<p>LF4154</p>  <p>IVECO 1161934</p> <p>Overall Height: 6.85 (174) Largest OD: 3.68 (94) ADB: Yes BPV Setting: 36.26 (250) Thread Size: 1-12 UNF-2B</p>	<p>LF9025</p>  <p>INTERNATIONAL TRUCKS 1841606C1</p> <p>Overall Height: 13.88 (353) Largest OD: 4.68 (119) Thread Size: M95 X 2.0 - 7H INT</p>
<p>LF4093</p>  <p>EMD/GENERAL MOTORS 8340000</p> <p>Overall Height: 7.44 (189) Overall OD: 2.91 (74) End 1 ID: 1.00 (25)</p>	<p>LF4156</p>  <p>DAF 323240</p> <p>Overall Height: 7.66 (195) Overall OD: 3.29 (84) End 1 ID: 0.97 (25)</p>	<p>LF9026</p>  <p>ENGINE SUPPORT ES9026</p> <p>Overall Height: 12.19 (310) Largest OD: 5.41 (137) BPV Setting: 27.99 (193) Thread Size: M36 X 1.5-5H</p>
<p>LF4094</p>  <p>EMD/GENERAL MOTORS 8322064</p> <p>Overall Height: 20.00 (508) Overall OD: 4.50 (114) End 1 ID: 1.18 (30)</p>	<p>LF9000</p>  <p>CASE 324617A1, CUMMINS 3101868 Is a longer version of LF9001</p> <p>Overall Height: 13.88 (353) Largest OD: 4.68 (119) Thread Size: M95 X 2.5-7H INT</p>	<p>LF9027</p>  <p>DOOSAN 65055105032A</p> <p>Overall Height: 8.12 (206) Largest OD: 4.24 (108) Thread Size: 1 1/2-16 UN-2B</p>
<p>LF4104</p>  <p>CASE 3055230R92</p> <p>Overall Height: 8.78 (223) Largest OD: 3.73 (95) ADB: Yes BPV Setting: 20.16 (139) Thread Size: 1-12 UNF-2B</p>	<p>LF9001</p>  <p>CUMMINS 3101869 Is a short version of LF9000</p> <p>Overall Height: 11.60 (295) Largest OD: 4.68 (119) Thread Size: M95 X 2.5-7H INT</p>	<p>LF9028</p>  <p>KUBOTA 300046300</p> <p>Overall Height: 6.94 (176) Largest OD: 3.69 (94) Thread Size: 1-16 UN-2B</p>
<p>LF4105</p>  <p>MERCEDES-BENZ 1844125, HENGST E19657</p> <p>Gasket: 3319874, 3320127, 3320129, 3328578 Overall Height: 7.70 (196) Overall OD: 4.55 (116) End 1 ID: 2.21 (56)</p>	<p>LF9008</p>  <p>FIAT HITACHI 71423006, HITACHI 4448336, HITACHI 76612484</p> <p>Overall Height: 9.91 (252) Largest OD: 4.81 (122) Thread Size: 1 1/2-12 UNS-2B</p>	<p>LF9030</p>  <p>CARRIER 20119182C, THERMO-KING 119182</p> <p>Overall Height: 6.94 (176) Largest OD: 3.69 (94) Thread Size: 1 1/8-12 UNF-2B</p>
<p>LF4112</p>  <p>MANN & HUMMEL W11102</p> <p>Gasket: 3320169 Overall Height: 10.26 (261) Largest OD: 4.33 (110) ADB: Yes BPV Setting: 36.26 (250) Thread Size: 1 1/8-16 UN-2B</p>	<p>LF9009</p>  <p>CUMMINS 3401544, SISU 1216400561, JOHN DEERE AT193242 Filter used with 3934644S Upgrade of LF3000 Venturi Combo Filter</p> <p>Overall Height: 11.88 (302) Largest OD: 4.68 (119) Thread Size: 2 1/4-12 UNS-2B</p>	<p>LF9031</p>  <p>CUMMINS 4906633 Vamac rubber outer gasket</p> <p>Overall Height: 11.81 (300) Largest OD: 4.68 (119) Thread Size: M95 X 2.5-7H INT</p>
<p>LF4118</p>  <p>ALCO LOCOMOTIVE 16011911</p> <p>Overall Height: 33.88 (860) Overall OD: 6.40 (163) End 1 ID: 1.46 (37)</p>	<p>LF9010</p>  <p>JOHN DEERE RE58935</p> <p>Overall Height: 11.57 (294) Largest OD: 4.68 (119) Thread Size: M52 X 1.5-6H INT</p>	<p>LF9034</p>  <p>CUMMINS 4197219 Cummins QSK78</p> <p>Overall Height: 11.86 (301) Largest OD: 7.10 (180) Thread Size: M90 X 2-7H INT</p>
		<p>LF9035</p>  <p>International I-313</p> <p>Overall Height: 10.50 (267) Largest OD: 4.68 (119) Thread Size: M92 X 2-6G EXT</p>

E. PRODUCT GUIDE

<p>LF9039 CUMMINS 4906635 Vamac rubber outer gasket</p>  <p>Overall Height: 11.83 (301) Largest OD: 4.68 (119) Thread Size: 2 1/4-12 UNS-2B</p>	<p>LF9747 Upgrade of LF3453, LF747 Venturi Combo Filter</p>  <p>Overall Height: 11.31 (287) Largest OD: 4.74 (120) Thread Size: 1 1/2-12 UNS-2B</p>	<p>LF16031 CUMMINS 3420742</p>  <p>Overall Height: 15.61 (397) Overall OD: 7.72 (196) End 1 ID: 4.67 (119)</p>
<p>LF9050 KOMATSU BF5209, CUMMINS 3101870</p>  <p>Overall Height: 11.71 (297) Largest OD: 4.72 (120) Thread Size: M90 X 2-7H INT</p>	<p>LF9931 Upgrade of LF3781, LF3931 Venturi Combo</p>  <p>Overall Height: 12.20 (310) Largest OD: 5.38 (137) Thread Size: M 45 X 1.5-6H</p>	<p>LF16034 KUKJE MACHINERY CO. HRA11020F4A3</p>  <p>Overall Height: 3.52 (89) Largest OD: 3.31 (84) BPV Setting: 12.47 (86) Thread Size: M20 X 1.5-6H INT</p>
<p>LF9325 Upgrade of LF3325, LF3363, LF670 Venturi Combo Filter</p>  <p>Overall Height: 11.31 (287) Largest OD: 4.74 (120) Thread Size: 1 1/2-12 UNS-2B</p>	<p>LF16002 Upgrade of LF3681</p>  <p>Overall Height: 3.85 (98) Largest OD: 3.69 (94) ADBV: Yes BPV Setting: 7.98 (55) Thread Size: M22 X 1.5-6H INT</p>	<p>LF16035 Upgrade of LF3972 Stratapore version of LF3972. This filter is similar to LF3894 except it has a fluted shell for 03MY Dodge Ram application.</p>  <p>Overall Height: 6.94 (176) Largest OD: 3.68 (93) Thread Size: 1-16 UN-2B</p>
<p>LF9333 Upgrade of LF3333, LF3380 Venturi Combo Filter</p>  <p>Overall Height: 9.82 (249) Largest OD: 4.74 (120) Thread Size: 1 1/2-12 UNS-2B</p>	<p>LF16006 CUMMINS 3977910 Used on 6B engines, Remote Mount Unit</p>  <p>Overall Height: 6.94 (176) Largest OD: 3.68 (94) ADBV: Yes Thread Size: 1-16 UN-2B</p>	<p>LF16042 DAF 1397764</p>  <p>Overall Height: 5.87 (149) Overall OD: 4.41 (112) End 1 ID: 2.22 (57)</p>
<p>LF9548 Upgrade of LF3548 Venturi Combo</p>  <p>Overall Height: 9.36 (238) Largest OD: 4.68 (119) Thread Size: 2 1/4-12 UNS-2B</p>	<p>LF16007 KOMATSU 6733515142</p>  <p>Overall Height: 5.82 (148) Largest OD: 3.69 (94) ADBV: Yes Thread Size: 1-16 UN-2B</p>	<p>LF16043 JOHN DEERE RE509672</p>  <p>Overall Height: 5.79 (147) End 1 OD: 4.80 (122) End 2 OD: 4.76 (121) End 1 ID: 0.56 (14) End 2 ID: 2.22 (57)</p>
<p>LF9620 Upgrade of LF3620, LF3671 Stratapore and Stack Disc Media, Full flow, By-Pass Venturi Combo</p>  <p>Overall Height: 9.82 (249) Largest OD: 4.74 (120) Thread Size: 1 5/8-12 UNS-2B</p>	<p>LF16008 WUXI DIESEL 101201029D</p> <p>LF16009 WUXI DIESEL 111810129D</p>	<p>LF16046 MERCEDES-BENZ 1802109</p>  <p>Overall Height: 10.37 (264) Overall OD: 4.76 (121)</p>
<p>LF9667 Upgrade of LF3321, LF3379, LF667 Venturi Combo Filter</p>  <p>Overall Height: 10.39 (264) Largest OD: 4.24 (108) Thread Size: 1 1/8-16 UN-2B</p>	<p>LF16011 CUMMINS C6002112110</p>  <p>Overall Height: 3.52 (89) Largest OD: 3.05 (77) ADBV: Yes BPV Setting: 28.60 (197) Thread Size: 3/4-16 UNF-2B</p>	<p>LF16050 TORO 1045167, KUBOTA 1524132099</p>  <p>Overall Height: 3.19 (81) Largest OD: 3.31 (84) ADBV: Yes BPV Setting: 7.98 (55) Thread Size: M20 X 1.5-6H INT</p>
<p>LF9691 Upgrade of LF3374, LF691 Venturi Combo Filter</p>  <p>Overall Height: 11.31 (287) Largest OD: 4.74 (120) Thread Size: 1 1/2-16 UNS-2B</p>	<p>LF16013 WUXI DIESEL 10120107000000, FAW JIEFANG AUTOMOTIVE CO.,LTD 1012010D6</p>  <p>Overall Height: 6.96 (177) Largest OD: 3.68 (94) Thread Size: M27 X 2-6H INT</p>	<p>LF16051 TATA 252518130129</p> <p>LF16056 TATA 253418130169</p>
<p>LF9691A Upgrade of LF3566, LF691A Venturi Combo Filter</p>  <p>Overall Height: 12.20 (310) Largest OD: 5.38 (137) Thread Size: 1 1/2-16 UNS-2B</p>	<p>LF16015 CUMMINS 4897898, DAF 1399494</p> <p>LF16028 MASSEY-FERGUSON 3757038M2, AGCO 3757038M2 Similar to the LF16011 with no by-pass valve</p>   <p>Overall Height: 3.21 (82) Largest OD: 3.05 (77) ADBV: Yes BPV Setting: 28.60 (197) Thread Size: 3/4-16 UNF-2B</p>	<p>LF16055 TATA 253418130165</p> <p>LF16062 TATA 253418130165</p> <p>LF16087 CUMMINS POWER GENERATION LTD 1220922</p>

E. PRODUCT GUIDE

LF16101 MACK 485GB3191C .



Overall Height: 10.39 (264)
Largest OD: 4.24 (108)
Thread Size: 1 1/8-16 UN-2B

LF16102 GMC 97214983



Overall Height: 5.41 (137)
Largest OD: 3.69 (94)
BPV Setting: 13.50 (93)
Thread Size: 13/16-16 UNS-2B

LF16104 GMC 25014748 Upgrade of LF3945 L-6 engines



Overall Height: 4.58 (116)
Largest OD: 3.05 (77)
ADBV: Yes
Thread Size: 13/16-16 UNS-2B

LF16106 JOHN DEERE RE521548



Overall Height: 7.19 (183)
Largest OD: 5.08 (129)
Thread Size: 1 5/8-12 UNS-2B

LF16108 KOHLER 1205001



Overall Height: 2.56 (65)
Largest OD: 3.05 (77)
ADBV: Yes
BPV Setting: 7.98 (55)
Thread Size: 3/4-16 UNF-2B

LF16109 GMC 26324057



Overall Height: 3.44 (87)
Largest OD: 3.69 (94)
Thread Size: 13/16-16 UNS-2B

LF16110 HINO 15613E0030



Overall Height: 8.09 (205)
Largest OD: 4.74 (120)
Thread Size: 1 1/2-16 UNS-2B

LF16111 FRAM PH6583



Overall Height: 4.57 (116)
Largest OD: 3.05 (77)
BPV Setting: 17.50 (121)
Thread Size: M20 X 1.5-6H INT

LF16113 FORD 1088179



Overall Height: 2.43 (62)
Overall OD: 3.60 (92)
End 1 ID: 1.34 (34)

LF16117 IVECO 504084161 Replaces LF16023



LF16121 CUMMINS 4899247



Overall Height: 3.58 (91)
Largest OD: 3.68 (94)
Thread Size: M27 X 2-6H

LF16129 KHD(KLOCKNER-HUMBOLDT-DEUTZ) 12128936



Overall Height: 11.89 (302)
Largest OD: 5.51 (140)
ADBV: Yes
BPV Setting: 36.26 (250)
Thread Size: 1 1/2-16 UNF-2B

LF16133 International Applications



Overall Height: 9.63 (245)
Largest OD: 5.41 (137)
BPV Setting: 27.99 (193)
Thread Size: M45X1.5-7H

LF16139A JOHN DEERE M146082

LF16143 BAUDOUIIN 12430780S



Overall Height: 8.98 (228)
Overall OD: 4.15 (106)
End 1 ID: 0.89 (23)

LF16144 MERCEDES-BENZ A0001801709 Contains 3 Metal Gaskets for Mexican Market.



Overall Height: 8.37 (213)
Overall OD: 3.31 (84)
End 1 ID: 1.56 (40)

LF16145 MITSUBISHI 35C4001100



Overall Height: 8.07 (205)
Largest OD: 4.27 (109)
Thread Size: 1 1/8-16 UN-2B

LF16147 MITSUBISHI 3254021600 Similar to LF3328 except for media.



Overall Height: 6.59 (167)
Largest OD: 4.24 (108)
Thread Size: 1 1/8-16 UN-2B

LF16149 PURFLUX L129



Overall Height: 11.85 (301)
Overall OD: 8.39 (213)
End 1 ID: 3.15 (80)

LF16157 KUBOTA 1627132090 Fluted shell version of LF3536



Overall Height: 4.02 (102)
Largest OD: 3.34 (85)
ADBV: Yes
BPV Setting: 7.98 (55)
Thread Size: M20 X 1.5-6H INT

LF16161 I-335 full flow filter



Overall Height: 10.50 (267)
Largest OD: 4.68 (119)
Thread Size: M92 X 2-6G EXT

LF16162 INTERNATIONAL TRUCKS 1850832C1



Overall Height: 11.32 (287)
Largest OD: 4.74 (120)
Thread Size: 1 1/4-12 UNF-2B

LF16165 ONAN 1220836



Overall Height: 4.40 (112)
Largest OD: 2.69 (68)
BPV Setting: 8.00 (55)
Thread Size: 3/4-16 UNF-2B

LF16166 FORD 3C3Z6731AA



Overall Height: 7.13 (181)
Overall OD: 3.28 (83)

LF16172 IVECO 2995561



Overall Height: 6.81 (173)
Largest OD: 3.68 (94)
Standpipe: YES
ADBV: Yes
BPV Setting: 36.26 (250)
Thread Size: M22 X 1.5-6H INT

LF16173 JOHN DEERE RE519626



Overall Height: 5.62 (143)
Largest OD: 3.68 (93)
ADBV: Yes
BPV Setting: 23.21 (160)
Thread Size: M24 X 1.5-6H INT

LF16176 BOSCH 1457429619



Overall Height: 6.02 (153)
Overall OD: 2.56 (65)
End 1 ID: 0.75 (19)

LF16182 MANN & HUMMEL HU9326N



Overall Height: 4.30 (109)
Overall OD: 3.27 (83)
End 1 ID: 0.83 (21)
End 2 ID: 1.46 (37)

E. PRODUCT GUIDE

LF16183	ROLLS ROYCE 703931		Overall Height: 13.15 (334) Overall OD: 7.93 (202) End 1 ID: 5.43 (138)
LF16208	FORD D9AZ6731A Mexico only		Overall Height: 5.35 (136) Largest OD: 3.66 (93) Thread Size: 3/4-16 UNF-2B
LF16209	GMC 6438384 Mexico only		Overall Height: 5.35 (136) Largest OD: 3.66 (93) Thread Size: 13/16-16 UN-2B
LF16210	CHRYSLER 3549957 Mexico only		Overall Height: 4.13 (105) Largest OD: 3.66 (93) Thread Size: 3/4-16 UNF-2B
LF16211	NISSAN 43001000 Mexico only		Overall Height: 3.35 (85) Largest OD: 2.56 (65) Thread Size: M20 X 1.5-6H INT
LF16212	FORD E1EE6714AA Mexico only		Overall Height: 4.88 (124) Largest OD: 2.91 (74) Thread Size: 3/4-16 UNF-2B
LF16213	GMC 6439929 Mexico only		Overall Height: 3.35 (85) Largest OD: 2.91 (74) Thread Size: M18 X 1.5-6H INT
LF16214	FORD F1AZ6731A Mexico only		Overall Height: 3.86 (98) Largest OD: 3.66 (93) Thread Size: M22 X 1.5-6H INT
LF16215	CHRYSLER 5281090 Mexico only		Overall Height: 3.86 (98) Largest OD: 3.66 (93) Thread Size: 3/4-16 UNF-2B
LF16216	GMC 5578052 Mexico only		Overall Height: 4.09 (104) Largest OD: 3.66 (93) Thread Size: 13/16-16 UNF
LF16217	GMC 12555891 Mexico only		Overall Height: 4.88 (124) Largest OD: 2.91 (74) Thread Size: M18 X 1.5-6H INT

LF16218	GMC 25014377 Mexico only		Overall Height: 3.94 (100) Largest OD: 2.91 (74) Thread Size: 3/4-16 UNF-2B
LF16219	GMC 25010251 Mexico only		Overall Height: 3.94 (100) Largest OD: 2.91 (74) Thread Size: 3/4-16 UNF-2B
LF16220	GMC 25010792 Mexico only		Overall Height: 5.35 (136) Largest OD: 3.66 (93) Thread Size: 13/16-16 UN-2B
LF16221	NISSAN 1520813201 Mexico only		Overall Height: 4.88 (124) Largest OD: 2.91 (74) Thread Size: 3/4-16 UNF-2B
LF16222	NISSAN 1520855Y00 Mexico only		Overall Height: 4.17 (106) Largest OD: 2.91 (74) Thread Size: 3/4-16 UNF-2B
LF16224	HYUNDAI 2630035502		Overall Height: 3.03 (77) Largest OD: 3.66 (93) Thread Size: M20 X 1.5 INT
LF16226	HINO 156072190		Overall Height: 8.33 (212) Largest OD: 4.88 (124) Thread Size: 1 1/2-16 UNS-2B
LF16227	MANN & HUMMEL W93026		Overall Height: 4.61 (117) Largest OD: 3.66 (93) Thread Size: M26 X 1.5 INT
LF16228	SCANIA 1873014 Uses service part: 3934841S		Overall Height: 10.19 (259) End 1 OD: 4.04 (103) End 2 OD: 3.94 (100)
LF16231	MANN & HUMMEL HU821		Overall Height: 3.74 (95) Overall OD: 2.82 (72)
LF16232	DAF 1397765		Overall Height: 8.66 (220) Overall OD: 4.44 (113) End 1 ID: 2.67 (68)
LF16233	DAF 1643070		Overall Height: 8.66 (220) Overall OD: 4.44 (113) End 1 ID: 2.20 (56)

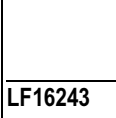
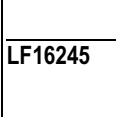
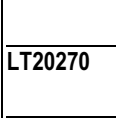
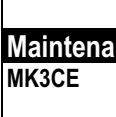
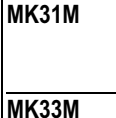
LF16242	GMC 89017524		Overall Height: 3.34 (85) Largest OD: 2.95 (75) Thread Size: M22 X 1.5-6G EXT
LF16243	JOHN DEERE RE507522		Overall Height: 5.94 (151) Largest OD: 3.66 (93) Thread Size: M92 X 2.5-6H INT
LF16245	MTU 31845301 MTU Construction Equipment		Overall Height: 11.89 Dome OD: 5.354 Thread Size: 1 1/2-16 UN-2B
LT20270	Literature ES EG Sticker, to build MK12550		
LT20276	Literature, ES Filter Sticker, to build MK12550		

Maintenance Kits

MK3CE	CUMMINS LF750B, LF516, FF105, WF2071
MK31M	MACK LF667(2), FF172, FF171, WF2015
MK33M	MACK LF667(3), FF172, FF222, WF2022
MK198	CUMMINS LF750B, LF670, FF105, WF2071, 164159S
MK1410	CUMMINS LF777(2), LF670(4), FF202(2), WF2071(4)
MK1451	CUMMINS LF777, LF670, FS1212, WF2071
MK1462	CATERPILLAR LF691, FF211
MK1465	CUMMINS LF777, LF670, FF105, WF2071
MK1466	INTERNATIONAL TRUCKS LF3316(2), FF5020, FF5019
MK1468	CUMMINS LF777, LF670, FF105
MK1483	CUMMINS LF777, LF670, FF104, WF2071
MK1519	INTERNATIONAL TRUCKS LF3316(2), FF5020, FF5019, WF2051
MK1530	CUMMINS LF777, LF670, FS1212

E. PRODUCT GUIDE

MK1538	CUMMINS LF777, LF670(2), FS1212(2), WF2071	MK11267	INTERNATIONAL TRUCKS LF3455(2), FF5020, FF5019	MK11447	GMC LF3342, FF5033, AF400, LF692
MK1547	CATERPILLAR LF3342(2), FF185	MK11273	FORD LF3443(2), FF42002(2), FS1234, WF2071	MK11467	CUMMINS LF3000, FS1212, WF2072
MK1549	DETROIT DIESEL LF670, FF5207, FF5206	MK11277	INTERNATIONAL TRUCKS LF3420(2), FF5020, FF5019, WF2071	MK11498	CUMMINS LF3000, FS1251, WF2071
MK1599	INTERNATIONAL TRUCKS LF3344, FF5035, FF194	MK11356	CUMMINS LF3000, FS1206, WF2071	MK11499	CUMMINS LF3349, FF42000, FS1240, HF6056, HF6243
MK11002	INTERNATIONAL TRUCKS LF690(2), FF196, FF5019	MK11361	CUMMINS LF3000, FS1212	MK11511	CATERPILLAR LF667, FF185, FF105
MK11012	THERMO-KING LF3361, FF204	MK11362	MACK CS41000, LF667(2), FF172, FF222	MK11513	GMC LF653, FF5033, AF380
MK11021	INTERNATIONAL TRUCKS LF3316(2), FF5020, FF5019, WF2071	MK11368	CATERPILLAR LF691A, FF211, FS1212, WF2071	MK11517	CATERPILLAR LF691A, FF211, FF105, WF2071
MK11029	INTERNATIONAL TRUCKS LF3420(2), FF5020, FF5019	MK11371	CATERPILLAR LF691, FF211, FS1212	MK11519	CUMMINS LF3349, FS1251
MK11033	CARRIER LF778, LF699, FF200, FF185	MK11372	CATERPILLAR LF691A, FF211, WF2071	MK11556	CUMMINS LF3000, FS1212, WF2051
MK11053	CUMMINS LF3000, FS1212, WF2071	MK11375	DETROIT DIESEL LF3333(2), LF777, FF5206	MK11557	FORD LF697, FF5033, HF6056, AF4967
MK11057	MACK CS41000, LF667(2), FF172, FF222, WF2022	MK11387	INTERNATIONAL TRUCKS LF3420(2), FF5078	MK11562	DETROIT DIESEL LF3620(2), FF5207, FF5206
MK11059	CATERPILLAR LF691, FF211, WF2071	MK11389	INTERNATIONAL TRUCKS LF3455(2), FF5020, FF5019, WF2071	MK11577	VOLVO LF777, LF3321, FF42000(2)
MK11060	CATERPILLAR LF691, FF211, FF105	MK11394	FORD LF3443(2), FF42002(2), WF2071	MK11582	INTERNATIONAL TRUCKS LF3420(2), FF5078, FS1205, WF2071
MK11065	FORD LF3443(2), FF42002(2)	MK11397	CATERPILLAR LF691A, FF211, FF105	MK11584	THERMO-KING LF3536, FF204
MK11066	CUMMINS LF3000, FF105, WF2071	MK11402	DETROIT DIESEL LF777, LF3333(2), FF5206, FS19513, WF2071	MK11585	CUMMINS LF3000, FF5052
MK11115	CATERPILLAR LF691, FF211, FS1212, WF2071	MK11412	MACK CS41000, LF667(2), FF172, FF222, WF2015	MK11593	DETROIT DIESEL LF3620(2), FF5206
MK11116	MACK LF667(2), FF172, FF222	MK11424	CUMMINS LF3000, FS1242	MK11600	DETROIT DIESEL LF3620(2), FF5206, FS19513, WF2071
MK11128	CUMMINS LF3000, FF105	MK11429	MITSUBISHI LF3447, LF3432	MK11601	CUMMINS LF3000, FF213
MK11146	FORD LF3443(2), FF42002(2), FS1234, WF2070	MK11437	CATERPILLAR LF691A, FF211, FS19513, WF2071	MK11606	DETROIT DIESEL LF3620(2), FF5206, FS19513
MK11148	CARRIER LF699, FF200, FF185	MK11442	CATERPILLAR LF691A, FF211, FS1206	MK11608	CUMMINS LF3000, FF5052, FS1247, LF3342
MK11215	DETROIT DIESEL LF777, LF3333(2), FF5207, FF5206	MK11443	CATERPILLAR LF691A, FF211, FS1212	MK11612	FORD LF3443(2), FF42002(2), FS1247, WF2070
MK11217	CUMMINS LF3000, FS1212, WF2077	MK11446	CUMMINS LF777, LF670, FF105(2), WF2071	MK11620	DETROIT DIESEL LF3620(2), FF5206, FS1212, WF2071
MK11225	CUMMINS LF3349, FF5052, FS1280				

E. PRODUCT GUIDE

MK11623	DETROIT DIESEL LF3620(2), FF5206, WF2071	MK11813	CUMMINS LF3000, FS1000, WF2072	MK12019	DETROIT DIESEL LF3620(2), FF5207, FF5206, DCA60L
MK11632	CUMMINS LF3363(3), FF202(2)	MK11814	CUMMINS LF3000, FS1000, WF2073	MK12020	CATERPILLAR LF691, FF213, FF211, WF2073
MK11651	INTERNATIONAL TRUCKS LF3883, FF5078, WF2106, CC2525	MK11837	DETROIT DIESEL LF3333SC, FF235, FF5021	MK12021	CATERPILLAR LF691A(2), LF667, HF6097(2)
MK11654	CUMMINS LF3000, FF105, WF2053	MK11841	CUMMINS LF3000, FF5052, WF2072	MK12024	DETROIT DIESEL LF3671(2), FF5207, FF5206
MK11661	DETROIT DIESEL LF3620(2), FF5206, FS1212	MK11842	INTERNATIONAL TRUCKS LF3883, FF5078, WF2072	MK12025	CUMMINS LF3000, FS1001, WF2071
MK11663	INTERNATIONAL TRUCKS LF3883, FF5078	MK11843	INTERNATIONAL TRUCKS LF3630, FS1298, WF2071	MK12036	CUMMINS LF777(2), LF670(3), FF202
MK11665	CATERPILLAR LF3566, FF211, WF2071	MK11844	CUMMINS LF3349, FF5052	MK12039	CATERPILLAR LF691A, FF5369W, WF2071
MK11666	DETROIT DIESEL LF3620(2), FF5207, FF5206, WF2071	MK11861	FORD LF3681, FF5244	MK12042	CATERPILLAR LF691A(2), FF185, FF211, LF667
MK11669	CATERPILLAR LF667, FF185, WF2071	MK11868	GMC LF782, FF5026	MK12043	TOYOTA LF3599, AF25308
MK11699	CATERPILLAR LF691A, FF211, DCA60L	MK11874	CUMMINS LF3349(2), FS1253, AF25090	MK12048	CUMMINS LF3000, FS1001
MK11726	INTERNATIONAL TRUCKS LF3883, FF5078, WF2106	MK11884	TOYOTA LF3311, LF3400, AF437K	MK12049	CATERPILLAR LF691A, FF211
MK11736	IHC LF3883, FF5078, WF2071	MK11890	CATERPILLAR LF691A, FF211, FS1000, WF2071	MK12050	DETROIT DIESEL LF3620(2), FF5369W, WF2077
MK11743	ISUZU LF3563, LF3328, FF5108	MK11916	INTERNATIONAL TRUCKS LF3883, FF5078, HF6057	MK12054	DETROIT DIESEL LF9620(2), FF5207, FF5206
MK11772	CATERPILLAR LF691A(2), HF6098(4), HF6097	MK11959	CUMMINS FS1280, FF5052	MK12059	MERCEDES-BENZ LF3607(2)
MK11776	CUMMINS LF777(2), LF670(3), LF509N(2)	MK11967	CATERPILLAR LF3566, FF211, FS1212	MK12060	CUMMINS LF3000, FS1251
MK11778	CUMMINS LF777(2), LF670(4), FF202(2)	MK11971	INTERNATIONAL TRUCKS LF3883, FF5269, WF2106	MK12072	CARRIER LF778, LF787, FF5301
MK11779	CUMMINS LF777(2), LF670(4)	MK11977	GMC LF3679, FS1295	MK12073	THERMO-KING LF3746, FF5275, FF5276
MK11791	ISUZU LF3622, FF5114	MK11978	FORD LF3630, FS1298	MK12107	CATERPILLAR LF667, FF5324, WF2052
MK11800	DETROIT DIESEL LF3620(2), WF2071, FF5369W	MK11996	CUMMINS LF3000, FS1001, WF2073	MK12119	CUMMINS LF3639, FS1000, WF2071
MK11802	CATERPILLAR LF691A, FF5264	MK11997	CUMMINS LF3639, FS1212, WF2071	MK12120	CATERPILLAR LF691, FF211, FS1000, WF2071
MK11807	CUMMINS LF3000, FS1000	MK12001	VOLVO LF3654, LF3675(2), FF5272	MK12127	CATERPILLAR LF3566(2), FF5319(2), WF2052, 3838230S
MK11808	CUMMINS LF3000, FS1000, DCA60L	MK12008	CUMMINS LF3000, FF5369W	MK12131	DETROIT DIESEL LF3620(2), FF5206, FS1206, WF2071
MK11811	CUMMINS LF3000, FS1000, WF2071	MK12014	THERMO-KING LF3746, FF5275, FF5276, AH1189		
		MK12017	CATERPILLAR LF691A(2), FF211(2)		

E. PRODUCT GUIDE

MK12133	VOLVO LF3654, LF3321(2), FF5272, WF2108	MK12252	CATERPILLAR LF691, FF5264	MK12353	CATERPILLAR LF691A, FF5319
MK12134	CATERPILLAR LF691, FF5264, WF2071	MK12253	VOLVO FF5272, LF3321(2), LF3654	MK12354	GMC LF782, FF5033
MK12136	DETROIT DIESEL LF9620(2), FF5206, FS19513	MK12257	CUMMINS LF9009, FS1000, WF2071	MK12357	CUMMINS LF3970, FS19579E
MK12138	MACK CS41000, LF667(2), WF2015	MK12258	CUMMINS LF750B, LF670, FS1001, WF2071	MK12358	DETROIT DIESEL LF3620(2), FS1029W
MK12145	CUMMINS LF3000, FF5369W, WF2071	MK12259	CUMMINS LF670, LF777, FS1001, WF2071	MK12364	DETROIT DIESEL LF3620(2), FF5369W, WF2071, CC2525
MK12146	VOLVO LF3654, LF3675(2), FF5272, WF2108	MK12260	CATERPILLAR FF5319(2), LF691A(2)	MK12368	CATERPILLAR LF667, FF5321, FF5207
MK12150	INTERNATIONAL TRUCKS LF3883, FF5269	MK12264	INTERNATIONAL TRUCKS FF5269, HF6057, LF3883	MK12369	TRANSICOLD LF3490, FF185
MK12151	INTERNATIONAL TRUCKS LF3883, FF5052	MK12265	CATERPILLAR FF185, FF5319, LF667, LF691A(2)	MK12370	CATERPILLAR LF667, FF5321, WF2071
MK12154	THERMO-KING LF3641, LF3536, FF204	MK12267	CATERPILLAR LF691A, FF211, FF213	MK12371	THERMO-KING LF3536, FF204, LF3361
MK12159	CATERPILLAR LF3379, FF185, FF105, WF2071	MK12269	CATERPILLAR LF667, FF5324, FS1001	MK12376	INTERNATIONAL TRUCKS LF3883, FS1281, FF5269
MK12160	MACK CS41000, LF667(2), FF222, FS1219, WF2015	MK12272	CUMMINS LF3363, FS1001, WF2071	MK12379	GMC LF692, LF3342, FF5033
MK12174	MACK CS41000, LF667(2), FF222, FF172, WF2083, CC2602B	MK12277	CUMMINS LF3363, FS1001(2), HF6110(2), HF6111(3), WF2073	MK12381	CATERPILLAR LF691A, FF5319, FF5207
MK12175	CUMMINS WF2121, CC2602B, CC2840, CC2607B	MK12310	CUMMINS LF9009, WF2072, FS1000	MK12382	DETROIT DIESEL LF3380, FF235, FF5021
MK12176	CATERPILLAR LF3342(2), FF5245	MK12312	CUMMINS LF3000, FS1000, CC2602B, CC2525	MK12384	CUMMINS LF3000, FS1251, WF2072
MK12180	INTERNATIONAL TRUCKS LF3883, FF5269, WF2071	MK12313	CUMMINS LF9000, FS1000, CC2602B, CC2525	MK12389	CUMMINS LF3000, FS1022, WF2071
MK12185	INTERNATIONAL TRUCKS LF3455(2), FF5078, AF364, HF6056, HF6110, HF6162	MK12320	CUMMINS LF9009, FS1212	MK12390	CUMMINS LF9009, FS1000, WF2077
MK12201	INTERNATIONAL TRUCKS LF3630, FS1298, WF2071, HF6056	MK12331	VOLVO LF3321, LF3654, FF5074(2)	MK12391	FORD AF25590, LF3681, FF5033
MK12221	CATERPILLAR LF691A, LF777, FF5264	MK12339	MACK LF667(2), FF5381, FF5382	MK12392	CUMMINS LF9001, FS1011
MK12223	DETROIT DIESEL FF5369W, LF3620(2)	MK12343	CATERPILLAR LF691A, FS1212, FF5319, WF2071	MK12393	CUMMINS LF3000, FS1022
MK12235	DETROIT DIESEL FF5369W, LF3671(2)	MK12348	MACK FF5381, FF5382, LF667(2), WF2015, CS41000	MK12394	CUMMINS LF3000, FS1022, WF2074
MK12238	DETROIT DIESEL LF3620(2), FF5207	MK12351	CATERPILLAR LF667, FF5324	MK12396	CATERPILLAR FF5035, LF667
MK12248	INTERNATIONAL TRUCKS LF3883, WF2071, FF5019	MK12352	CATERPILLAR LF667, FF5321	MK12401	CUMMINS LF3000, FS1029W, CC2602B
				MK12402	MACK FF5381, FF5382, LF667(2), CS41000
				MK12404	CUMMINS LF9000, FS1000, WF2071

E. PRODUCT GUIDE

MK12405	CUMMINS LF3342, LF3349, FS1251, FF5079, HF6510	MK12466	CATERPILLAR LF9691A, FF5319	MK12507	HOLDEN AF25372, FF5030, LF3528
MK12406	CATERPILLAR LF691A, FF5207, FF5264, WF2071	MK12471	CATERPILLAR LF691A, FF5319, FS1000, WF2071	MK12508	HOLDEN AF1649, FF149, LF3336
MK12411	CUMMINS LF3970, LF3342, HF6057, FS19579E	MK12472	CATERPILLAR LF3566, FF5319, FS1000, CC2525	MK12509	HOLDEN AF4975, FF5180, LF3462
MK12418	CATERPILLAR LF667, FF5324, FF5052	MK12473	MACK LF3379(2), CS41000, FF5381, FF5382	MK12511	FORD FF5244, LF3313
MK12421	NISSAN LF3434, AF4973K	MK12476	CUMMINS LF9001, FS1000, WF2071	MK12512	NISSAN AF1649, FF5114, LF690
MK12425	ISUZU LF3379, FF5052, FF5321	MK12478	DETROIT DIESEL LF3671(2), FF5206	MK12513	NISSAN AF4615, FF5180, LF3434
MK12430	CUMMINS LF3000, FF5369W, CC2602B	MK12479	CUMMINS LF9000, FS1000, WF2122	MK12514	NISSAN FF5307, LF3659
MK12435	CUMMINS LF9001, FS1000, WF2072	MK12484	CATERPILLAR LF667, FF5207, FF5321, LF3342	MK12515	NISSAN AF1778, FF5180, LF3434
MK12436	CATERPILLAR LF3379, FF5321	MK12486	DETROIT DIESEL LF3620(2), FS1029W	MK12516	NISSAN AF1649, FF5180, LF3435
MK12437	GMC LF692, LF3342, FF5033, AF25259	MK12487	CUMMINS LF9001, FS1000, CC2602B	MK12518	TOYOTA FF5159, LF3313
MK12438	CATERPILLAR LF691A, FF5319, FS1001	MK12488	CUMMINS LF3000, FS1000, CC2602B	MK12519	TOYOTA AF25295, FF5159, LF3313
MK12439	CUMMINS LF9000, FF5369W, WF2071	MK12489	DETROIT DIESEL LF3620(2), FF5206, FF5207, CC2602B	MK12520	TOYOTA AF4509, FF5114, LF3313
MK12441	CUMMINS LF9009, FS1000, WF2073	MK12494	INTERNATIONAL TRUCKS LF3883, FF42002	MK12521	TOYOTA AF4509, FF5030, LF3313
MK12442	CATERPILLAR LF9691A(2), FF5319(2), WF2052	MK12496	CATERPILLAR LF691, FF5369W	MK12522	TOYOTA FF5030, LF3399
MK12443	KOMATSU LF3363(2), FS1000(2), LF777, WF2052	MK12498	DETROIT DIESEL LF9620(2), FF5369W	MK12523	MITSUBISHI AF25500K, FF5160, LF3830
MK12445	CATERPILLAR LF9691A(2), FF5319	MK12499	DETROIT DIESEL LF3620(2), FS19536	MK12524	MITSUBISHI FF5179, LF3336
MK12449	CATERPILLAR HF6341(2), HF6342(2)	MK12500	TOYOTA AF4509, FF5030, FF5385, LF3399	MK12525	MITSUBISHI FF5160, LF3830
MK12450	MACK LF3379, CS41000, FF5381, FF5382, WF2015	MK12501	TOYOTA AF4509, FF5159, LF3608	MK12526	MITSUBISHI AF25447, FF5221, LF3336
MK12452	CATERPILLAR LF9691A(2), FF5319, WF2052	MK12502	HOLDEN AF4616, FF5030, LF3433	MK12527	MITSUBISHI FF5224, LF3336
MK12453	CATERPILLAR HF6344(4), HF6341	MK12503	HOLDEN AF4616, FF5030, LF3508	MK12528	TOYOTA AF4509, FF5030, LF3399
MK12457	CATERPILLAR LF9691A, FF5319, WF2051	MK12504	HOLDEN AF4616, FF5030, LF3528	MK12529	TOYOTA AF4956, FF5177, LF3874
MK12460	CATERPILLAR LF9691, FS1000, FF5319, WF2072	MK12505	HOLDEN FF5180, LF3462	MK12546	CATERPILLAR LF777, LF691A, FF5264, 255622S
		MK12506	HOLDEN AF1649, FF5030, LF3433	MK12547	CUMMINS LF9009, FS1000
				MK12552	TOYOTA AF4509, LF3608, FF5159, HF6173, FF5385

E. PRODUCT GUIDE

MK12557	CUMMINS LF9000, FS1000	MK12684	CUMMINS LF9001, FS1007	MK12770	MACK LF9667(2), CS41005, WF2015
MK12559	CUMMINS LF9001, FS1007, WF2126	MK12685	CATERPILLAR LF691A, FS1212, FF5264	MK12775	VOLVO LF3675(2), LF3654, FF5369W
MK12560	THERMO-KING LF694, FF204, FS1225	MK12687	THERMO-KING LF3746, FS19580, AH1189	MK12777	CUMMINS LF9001, FS1000, WF2051
MK12561	THERMO-KING LF787, FF185, FF200	MK12688	CATERPILLAR LF691A, FF5319, FS1212	MK12778	CUMMINS LF9001, HF7608, FS1000, WF2051
MK12563	CUMMINS FF42000, FS1240, HF6243, HF6710, HF7996, LF3349	MK12690	GMC LF3679, FF5033	MK12779	CATERPILLAR LF667, FF185(2)
MK12566	CUMMINS LF9009, FS1022	MK12691	SCANIA LF3730, 3931308S	MK12782	CUMMINS LF3000, FS1029W, FS1000, WF2071
MK12568	DETROIT DIESEL LF3620(2), FS1029W, WF2073	MK12693	CATERPILLAR LF691A, LF777, FF5319, FF105	MK12796	MACK LF667(2), FS19558, CS41005
MK12582	THERMO-KING LF694, LF695, FF185, FF204	MK12694	CUMMINS LF9001, FS1029W, WF2071	MK12803	CATERPILLAR LF9691, FF5319, FS1029W
MK12588	CATERPILLAR LF691A, FF5319, WF2077	MK12695	CATERPILLAR LF691A, FF5319, FF5207, WF2071	MK12812	CUMMINS LF9001, WF2072, FF5369W, CC2602B
MK12589	CUMMINS LF9009, FS1000, WF2070	MK12696	CATERPILLAR LF691A, FF5319, WF2071	MK12814	DETROIT DIESEL LF9620(2), FS19513, FF5206, WF2071
MK12593	CUMMINS LF9009, FS1029W, WF2072	MK12697	CATERPILLAR LF691A, FF5319, FS1000	MK12815	CATERPILLAR LF9691A, FF5207, FF5319, WF2071
MK12596	CUMMINS LF9001, FS1040, WF2126	MK12698	MACK LF667(2), CS41005, FF5381, FF5382	MK12816	CATERPILLAR LF691A, LF777, FF211, FS19532
MK12599	ISUZU LF551A, FF5108	MK12700	CATERPILLAR LF667, FF5320	MK12817	INTERNATIONAL HARVESTER LF3883, FF203, FF5269
MK12622	MACK LF667(2), CS41000, FF5369W	MK12746	CUMMINS LF9001, FS1000	MK12818	NAVISTAR LF3630, FS1298, HF6056
MK12623	MACK LF667(2), CS41000, FF5381, FF5382, FF222	MK12747	CUMMINS LF9001, FS1040	MK12820	PERKINS LF3615, AH19001, FF5260
MK12624	ISUZU LF3854, LF551A, FF5108	MK12749	GMC LF3679, LF3342, FF5033	MK12821	CUMMINS FF2200, LF9001, WF2126
MK12638	CATERPILLAR LF3566(3), FF5132(2), HF7473(2), HF7779	MK12750	CUMMINS LF9001, FS19557, CC2602B	MK12822	GMC LF796, FF5033
MK12639	DETROIT DIESEL LF3380(2), FF5036, FF5037	MK12756	CUMMINS LF3342, LF3349, FF149, FS1251, HF6056	MK12824	CUMMINS LF9001, FS1212
MK12641	NEW HOLLAND LF3630, FF5418	MK12758	CARRIER LF787, LF778, FF5458	MK12828	CATERPILLAR LF667, FS1251, FF5321
MK12672	THERMO-KING LF3746, FS19580	MK12759	CUMMINS LF9009, FS1022, WF2071	MK12831	CUMMINS LF9001, WF2127, FS19559
MK12673	CATERPILLAR LF691A, FF5319, FF105	MK12760	VOLVO LF9667(2), LF3654, FF5272	MK12845	FORD LF3681, FF5033
MK12674	CUMMINS LF3959, FS1280, FF5052	MK12763	MACK LF667(2), FF172, FF222, WF2015	MK12850	CATERPILLAR LF691A, FF105, FF185
MK12678	CUMMINS LF3959, FS1251	MK12764	CATERPILLAR LF3566, LF777, FS1029W	MK12852	CATERPILLAR FF5319, FF5369W, LF691A
MK12683	CATERPILLAR LF691A, FS1029W, FF5319				















E. PRODUCT GUIDE

MK12889	VOLVO LF3321(2), LF3654, FF5507	MK12963	CUMMINS FS1003, 3930618S	MK13027	MACK FF172, FF222, LF16101(3), WF2022
MK12897	MACK LF667(2), CS41005, FF5369W	MK12992	CUMMINS LF9001, FF2200, FS19729	MK13028	MACK FF172, FF222, LF16101(2), WF2022, CS41000
MK12902	CUMMINS LF9001, FS1029W	MK12993	CUMMINS LF9001, FF2200, FF2203, WF2126	MK13030	IHC LF3883, FF5019
MK12906	VOLVO LF3675(2), LF3654, FF5507, FF5369W	MK12995	MACK LF3973(2), CS41011	MK13031	CUMMINS LF3349, FF5052, FF5059, LF3342, HF6057
MK12907	MACK CS41005, LF16101, FF5369W	MK13006	CATERPILLAR LF777, LF3566, FF211	MK13032	CUMMINS LF9009, FF5052, FF5079, FS1280, WF2071
MK12909	CUMMINS LF16046, FF5405	MK13007	CUMMINS FF2200, FF2203, LF9001	MK13034	VOLVO LF3654, LF3675(2), WF2108, FF5507
MK12910	MERCEDES-BENZ LF9001, FF5369W, FF2200, WF2126	MK13008	CATERPILLAR LF777, LF3566, FF202, FF5319	MK13036	VOLVO LF3675(2), LF3654, FS19532, FF5507, WF2129
MK12917	CUMMINS WF2051, FS1000, LF9009	MK13009	CATERPILLAR LF691A, FS19683, FF5319	MK13037	CATERPILLAR LF3566, FF5319
MK12918	DETROIT DIESEL WF2051, FF5369W, LF3620(2)	MK13010	CUMMINS LF9001, FF2200, FS19729, WF2127	MK13038	CUMMINS LF9001, FS19729, WF2126, FF2200
MK12932	VOLVO LF3675(2), FF5507, LF3654	MK13012	FORD LF3681, FF5455	MK13039	CUMMINS LF9001, FS19729, WF2126
MK12933	CUMMINS FS1003, LF9009, WF2071, FF5488	MK13013	DEUTZ AG AF418, LF3311, FS20102, FF5040, HF6185, AF490M	MK13040	CUMMINS LF9001, FS19729
MK12941	INTERNATIONAL TRUCKS LF9620(2), FS19624	MK13014	CUMMINS LF3970, FS19596	MK13041	CUMMINS LF3959, FS1251, HF6057, LF3342
MK12942	CUMMINS LF9009, FS19624, WF2071	MK13015	DETROIT DIESEL LF3620(2), FS19624	MK13042	CATERPILLAR FF202, FF5319, LF691A
MK12945	CATERPILLAR LF691A, FS19624, FF5319	MK13016	CUMMINS FF5369W, LF9001	MK13043	MERCEDES-BENZ FS19624, LF3671(2), WF2051
MK12946	CATERPILLAR FF202, FF5319, LF691A	MK13017	CUMMINS LF3806, FS19616	MK13044	CATERPILLAR LF3566, CC2525, FF5319, FS1029W
MK12950	DETROIT DIESEL LF3620(2), FS19624, CC2602B	MK13019	CATERPILLAR LF3379, HF6553, FF5321, FF5322, FS19555	MK13045	CUMMINS LF9025, FS19684E
MK12952	MACK LF16101(2), FF5382, FF5381, CS41005	MK13020	CUMMINS LF9025, FS19684E, CS41013	MK13046	CUMMINS LF3854, FF5617
MK12953	MACK LF667, FF234, HF6243, 3838230S, FF5320, WF2015	MK13021	MACK LF3328(2), FF172, FF222, CS41000, HF6557, WF2015	MK13047	CUMMINS LF3671, FF5206, FS19513
MK12955	CATERPILLAR LF691A, FS1001, FF5320	MK13022	MERCEDES-BENZ LF3914, FF5380, FS19624	MK13048	VOLVO LF667(2), LF777, FF42000(2)
MK12956	MACK LF667(2), FF172, FF222, CS41000, HF6557, WF2015	MK13024	MACK FF172, FF222, LF16101(2), WF2015, CS41000	MK13049	CATERPILLAR LF9691A, FF5319, FF202
MK12959	MACK LF667(2), CS41010, FF5381, FF5382	MK13025	MACK FF172, FF171, LF16101(2), WF2015	MK13050	DETROIT DIESEL LF3671(2), FS19624
MK12961	CUMMINS FS19579E, HF6056(2), LF3970	MK13026	MACK FF172, FF171, LF16101(2), WF2015, CS41000	MK13051	MERCEDES-BENZ FF5405, LF16046, FS1029W















E. PRODUCT GUIDE

MK13052	VOLVO LF3675(2), LF3651, FS19728	MK13090	CATERPILLAR LF3566, FF5319, CC2525	MK13119	RENAULT TRUCKS FF5507, FS19735, LF3654, LF3675(2), 3959961, 3959962, 3959963 Gasket: 3959961 (1), 3959962(1), 3959963 (1)
MK13053	MACK LF3379(2), CS41005, FS19728	MK13091	CUMMINS LF667, FS1000, FF5321	MK13120	CUMMINS LF777, LF3566, FS19728, FF5319
MK13054	CUMMINS LF9001, FS1003, FS19727	MK13092	CATERPILLAR LF691A, FF5319, FS20201, WF2077	MK13121	CUMMINS LF3536, LF778, FF5301
MK13057	CUMMINS LF3914, FF5380, FS19513	MK13093	CUMMINS LF3914, FS19521, FF5380	MK13122	CUMMINS LF9009, FF5369W, WF2071
MK13058	CUMMINS LF9001, FF2200, FF5369W	MK13094	CUMMINS LF787, FF5380	MK13123	CUMMINS LF9009, FF5369W, WF2051
MK13061	CATERPILLAR LF3566, FS19729, FF5319	MK13095	CUMMINS LF3973(2), FS19558	MK13124	CUMMINS LF9009, FF5369W
MK13062	IHC LF16166, FF5418, HF35296	MK13096	CUMMINS LF3566, FF5319, FS1000	MK13125	CATERPILLAR LF691A, FF5369W, FF5319
MK13063	IHC LF3883, FF5269, HF35296	MK13097	CATERPILLAR LF691A, FF202, FF5264	MK13126	CUMMINS LF16046, FF5369W, FF5405
MK13064	MACK LF667(2), CS41000, FS1219, FF222, WF2015	MK13098	CUMMINS LF9001, FS19799, FF2200, WF2126	MK13127	DETROIT DIESEL LF9001(2), FF5369W
MK13065	MACK LF3973(2), CS41005, FS1029W, WF2015	MK13099	CUMMINS LF9001, FS1000, WF2123	MK13128	MERCEDES-BENZ FS19847, LF16046, FF5405
MK13066	CATERPILLAR LF3566, FF5319, FS19807	MK13100	CUMMINS LF3671(2), FS19727	MK13148	MACK LF3973(2), FS19624, CS41011
MK13067	MERCEDES-BENZ LF3914, FF5380, CS41008, FS19624	MK13103	CUMMINS LF695, LF702, FF204, FF185, AH1189	MK13149	CUMMINS LF3349, FS19616
MK13068	CUMMINS LF3654, LF3675(2), FF5507, FS19551	MK13104	CATERPILLAR LF667, FF5320, FF234, HF6243, HF35197(3), WF2051, 3838230S	MK13150	VOLVO LF3675(2), LF3654, FF5507, FS19624, WF2129
MK13069	CUMMINS LF691A, FF211, FF202	MK13106	CUMMINS LF9009, FS1029W	MK13151	DETROIT DIESEL LF9620(2), FS19624, WF2051
MK13070	CUMMINS LF9001, FF5488, FS1003	MK13107	CUMMINS LF9009, FS1029W, WF2071	MK13152	CUMMINS HF6243, FF42000, FS1240, LF3959, HF6730, 3312097S
MK13071	VOLVO LF3675(2), LF3654, FS1029W, FF5507	MK13108	CUMMINS LF9009, FS1029W, WF2051	MK13153	CUMMINS HF6243, FS1240, FS19596, LF3970, HF6730, 3312097S
MK13082	CUMMINS LF9009, FS1003, FF5488	MK13109	CATERPILLAR LF9691A, FF5207, FF5319	MK13154	CUMMINS HF6243, FS1000, FF5421, LF3970, HF6730, 3312097S
MK13083	PERKINS FF5260, LF3615	MK13110	CATERPILLAR LF9691A, FF5319, FS1029W	MK13155	MERCEDES-BENZ LF16046, FF5405, FS19593
MK13084	CUMMINS LF9001, FS19624	MK13111	DETROIT DIESEL LF9620(2), FF5206, FF5207, WF2051	MK13156	CUMMINS LF9001, FS19729, FF2200, WF2126, CC2602B
MK13085	CUMMINS LF3000, FF5488, FS1003	MK13112	DETROIT DIESEL LF9620(2), FS1029W	MK13157	CATERPILLAR LF691A, FS19536, FF5319, WF2071, CC2602B
MK13086	CUMMINS LF3854, FF5160, LF551A	MK13113	VOLVO LF3675(2), LF3654, FF5507, FF5369W, WF2108	MK13158	MERCEDES-BENZ LF16046, FS19558, FF5405, WF2071, CC2602B
MK13087	CUMMINS LF9009(2), FS1000(2), WF2076, CC2543, 3318168S, CC2602B	MK13118	CUMMINS LF3914, FF5380		

E. PRODUCT GUIDE

MK13159	DETROIT DIESEL LF3620(2), FS19558, WF2071, CC2602B	MK13191	CUMMINS LF9000, FF2200, FF5369W	RN24005	DAVCO 570720 Continuous Oil Change Module- 24 Volt DC- Quarts
MK13160	MERCEDES-BENZ LF16046, FF5405, WF2051	MK13193	MACK LF667(2), LF3654, FF5507		
MK13161	CUMMINS LF3000, FS1029W	MK13194	CUMMINS FF2200, FS1212, LF9001	RN24006	DAVCO 571002 Oil Level Regulator. Includes mounting bracket, hose and fittings.
MK13162	DETROIT DIESEL LF3620(2), FF5333, FS19513	MK13195	CUMMINS LF9001, FS19728, FF2200		
MK13163	CUMMINS LF3970, FF5632, FS19732	MK13196	CUMMINS LF9001, FF2200, FF2203, WF2127	RN24007	DAVCO 570102 Oil Level Regulator. Does not include mounting bracket, hose and fittings.
MK13165	CUMMINS LF9000, FF2200, FS19729, WF2126	MK13197	CUMMINS LF3000, FF5636, FS1003		
MK13168	MACK LF3973(2), FF5381, FF5643, CS41011, WF2015	Natural Gas Filters		RN24009	DAVCO 570233 Counter Assembly, MRA
MK13169	FREIGHTLINER FS19532, FF5380, LF16046, CC2548	NG5900	CUMMINS 3606712 Filter used with 3893692S L10G, B&C Natural Gas Version of 10 liter engine		
MK13170	FREIGHTLINER FS19532, FF5380, LF16144, CC2548		Overall Height: 7.35 (187) Largest OD: 3.78 (96) Thread Size: 1 1/2-16 UN-2B	RN24011	REN 111 Liquid Level Switch (U.L.)
MK13171	CUMMINS LF3970, FS19732, FF5421	Fluid Level Management			
MK13172	VOLVO LF9667(2), LF3654, FF5369W, FF5207	RN24000	DAVCO 570715 Continuous Oil Change Module- 12V DC- Gallons		
MK13173	CUMMINS LF703(2), FS19728, FF5319	RN24001	DAVCO 570716 Continuous Oil Change Module- 24V DC- Gallons		
MK13179	CUMMINS FS1029W, LF9009	RN24002	DAVCO 570717 Continuous Oil Change Module- 12 Volt DC- Liters		
MK13180	DETROIT DIESEL FS1029W, LF9620(2)	RN24003	DAVCO 570718 Continuous Oil Change Module- 24 Volt DC- Liters		
MK13181	VOLVO LF9667(2), LF3654, FF5272, FS1029W	RN24004	DAVCO 570719 Continuous Oil Change Module- 12 Volt DC- Quarts		
MK13182	CUMMINS LF9667(2), LF3654, FS1029W	RN24012	DAVCO 571009 5 Gallon (18.9 liter) Oil Supply Reservoir and Pedestal Stand with Calibrated Sight Gauge & Shutoff Valve		
MK13183	VOLVO LF9667(2), LF3654, FS1029W, FF5507	RN24014	DAVCO 570409 Tank with Sight Gauge & Shutoff Valve- REN Product		
MK13184	MACK LF3973(2), CS41011, FF5381, FF5382	RN24015	DAVCO 571011 Uses service part: 3946389S 15 Gallon (56.8 liter) Tank with Calibrated Sight Gauge, Shutoff Valve & Barrel Straps with 36" Stand		
MK13185	VOLVO LF3675(2), LF3654, FS19728, FF5507	RN24016	DAVCO 570101 Oil Level Regulator		
MK13189	MACK LF3973(2), FS19558, WF2015, CS41011				
MK13190	CUMMINS LF9000, FS1000, FF5369W				

E. PRODUCT GUIDE

RN24017	DAVCO 571012 Uses service part: 3946390S 30 Gallon (113.6 liter) Tank with Callibrated Sight Gauge, Shutoff Valve & Barrel Straps with 36" Stand 	RN24035	DAVCO 5701003603 Kit-Oil Regulator with Glass Window and Switch, RALUBO-GL/VN/SW 	ST1008	MP FILTRI STR1001SG1M90 This product is not available in all regions of the world Overall Height: 6.85 (174) Overall OD: 3.54 (90) Thread Size: 1 1/4 BSP	
RN24022	DAVCO 5702052602 Meter, MRM (gallon)	RN24036	DAVCO 5701003606 Kit-Oil Regulator with Bracket and 1/2" HXHD Plug, RABK 	ST1017	MP FILTRI STR1001BG1M90 This product is not available in all regions of the world Overall Height: 5.95 (151) Overall OD: 3.54 (90) BPV Setting: 2.90 (20) End 1 ID: 0.97 (25) Thread Size: 1 1/4 BSP	
RN24023	DAVCO 57020571 Slow Flow Meter, MRM (gallon)	RN24037	DAVCO 57010200 Solar Turbine Oil Level Regulator with Bracket, RAB 	ST1026	MP FILTRI HP1351A25AN This product is not available in all regions of the world Overall Height: 4.61 (117) Overall OD: 2.13 (54) End 1 ID: 1.02 (26)	
RN24025	DAVCO 57041000 5 1/2 Gallon Horizontal Tank- REN Product 	RN24038	DAVCO 57010234 Solar Turbine Oil Level Regulator with Bracket, Isoplast, EZ303 and Switch, RABO-SW/CN 	ST1028HH	Head used with HF7835, ST1814 This product is not available in all regions of the world	
RN24026	DAVCO 570204 Slow Flow Meter with electronic readout (gallon) - wire terminal	RN24039	DAVCO 57020381 Oil Level Regulator with Internal Anodizing (gallon)	ST1032	HYDAC 30D010BH3HC, HYDAC 305117 This product is not available in all regions of the world	
RN24027	DAVCO 570411 Lube Reservoir- REN Product 	RN24040	DAVCO 57010079 Oil Level Regulator 	ST1033	HYDAC 30D020BH3HC, HYDAC 322693 This product is not available in all regions of the world	
RN24028	DAVCO 57010133 Kit-Oil Regulator with Glass Window, RAK 	RN24041	DAVCO 5701007901 Oil Level Regulator. Consists of RN24040 and aluminum Y mounting bracket (3946909 S) attached and 2 fixing screws and washers. 	ST1034	HYDAC 60D003BH3HC, HYDAC 308082 This product is not available in all regions of the world	
RN24029	DAVCO 57010233 Kit-Oil Level Regulator with Glass Window, Bracket, RABO 	RN24042	DAVCO 57020481 Annodized Slow Flow Meter-REN Product 	ST1034	HYDAC 60D003BH3HC, HYDAC 308081 This product is not available in all regions of the world	
RN24030	DAVCO 57100130 Kit-Oil Level Regulator with Isoplast EZ203 Window, RA	RN24044	Replaces RN24020 Replaces RN24018 and RN24008.	ST1035	HYDAC 60D005BH3HC, HYDAC 308081 This product is not available in all regions of the world	
RN24031	DAVCO 5701000004 Kit-Oil Level Regulator used on Force Feed Oil Lubricator, RALUB-K 	RN24045	Replaces RN24021 and RN24010.	ST1036	HYDAC 60D010BH3HC, HYDAC 308080 This product is not available in all regions of the world	
RN24032	DAVCO 5701000006 Standard Oil Level Regulator used on Force Feed Oil Lubricator, RALUBO 	RN24046	DAVCO 571004	ST1036	Overall Height: 3.31 (84) Overall OD: 1.85 (47) End 1 ID: 0.83 (21)	
RN24033	DAVCO 57010033 Kit-Oil Level Regulator with Glass Window used on Force Feed Lubricator, RALUB-K	Hydraulic Filters			ST1000	PARKER FC5000Q010BS This product is not available in all regions of the world
RN24034	DAVCO 5701003302 Standard Oil Level Regulator with Glass Window and Switch, RALUBO-GL/VN/SW	ST1000	Overall Height: 6.18 (157) Overall OD: 2.87 (73) End 1 ID: 1.10 (28)	ST1001	This product is not available in all regions of the world Overall Height: 7.87 (200) Overall OD: 2.84 (72) End 1 ID: 0.28 (7)	

E. PRODUCT GUIDE

ST1037	HYDAC 60D020BH3HC, HYDAC 308079 This product is not available in all regions of the world Overall Height: 3.31 (84) Overall OD: 1.85 (47) End 1 ID: 0.83 (21)	ST1046	HYDAC 240D003BH3HC, HYDAC 308094 This product is not available in all regions of the world Overall Height: 6.89 (175) Overall OD: 2.72 (69) End 1 ID: 1.31 (33)	ST1055	HYDAC 660D005BH3HC, HYDAC 308101 This product is not available in all regions of the world Overall Height: 12.95 (329) Overall OD: 3.56 (91) End 1 ID: 1.84 (47)
ST1038	HYDAC 110D003BH3HC, HYDAC 308086 This product is not available in all regions of the world Overall Height: 6.02 (153) Overall OD: 1.85 (47) End 1 ID: 0.83 (21)	ST1047	HYDAC 240D005BH3HC, HYDAC 308093 This product is not available in all regions of the world	ST1056	HYDAC 660D010BH3HC, HYDAC 308100 This product is not available in all regions of the world Overall Height: 12.95 (329) Overall OD: 3.56 (91) End 1 ID: 1.84 (47)
ST1039	HYDAC 110D005BH3HC, HYDAC 308085 This product is not available in all regions of the world Overall Height: 6.02 (153) Overall OD: 1.85 (47) End 1 ID: 0.83 (21)	ST1048	HYDAC 240D010BH3HC, HYDAC 308092 This product is not available in all regions of the world Overall Height: 6.89 (175) Overall OD: 2.72 (69) End 1 ID: 1.31 (33)	ST1057	HYDAC 660D020BH3HC, HYDAC 308099 This product is not available in all regions of the world Overall Height: 12.95 (329) Overall OD: 3.56 (91) End 1 ID: 1.84 (47)
ST1040	HYDAC 110D010BH3HC, HYDAC 308084 This product is not available in all regions of the world Overall Height: 6.02 (153) Overall OD: 1.85 (47) End 1 ID: 0.83 (21)	ST1049	HYDAC 240D020BH3HC, HYDAC 308091 This product is not available in all regions of the world Overall Height: 6.89 (175) Overall OD: 2.72 (69) End 1 ID: 1.31 (33)	ST1058	HYDAC 30D025W, HYDAC 303973 This product is not available in all regions of the world Overall Height: 3.70 (94) Overall OD: 1.38 (35) End 1 ID: 0.48 (12)
ST1041	HYDAC 110D020BH3HC, HYDAC 308083 This product is not available in all regions of the world Overall Height: 6.02 (153) Overall OD: 1.85 (47) End 1 ID: 0.83 (21)	ST1050	HYDAC 330D003BH3HC, HYDAC 308098 This product is not available in all regions of the world Overall Height: 6.46 (164) Overall OD: 3.56 (91) End 1 ID: 1.84 (47)	ST1059	HYDAC 60D025W, HYDAC 301409 This product is not available in all regions of the world Overall Height: 3.58 (91) Overall OD: 1.75 (45) End 1 ID: 0.83 (21)
ST1042	HYDAC 160D003BH3HC, HYDAC 308090 This product is not available in all regions of the world Overall Height: 4.57 (116) Overall OD: 2.72 (69) End 1 ID: 1.31 (33)	ST1051	HYDAC 330D005BH3HC, HYDAC 308097 This product is not available in all regions of the world Overall Height: 6.46 (164) Overall OD: 3.56 (91) End 1 ID: 1.84 (47)	ST1060	HYDAC 304002 This product is not available in all regions of the world Overall Height: 6.22 (158) Overall OD: 1.75 (45) End 1 ID: 0.83 (21)
ST1043	HYDAC 160D005BH3HC, HYDAC 308089 This product is not available in all regions of the world Overall Height: 4.57 (116) Overall OD: 2.72 (69) End 1 ID: 1.31 (33)	ST1052	HYDAC 330D010BH3HC, HYDAC 308096 This product is not available in all regions of the world Overall Height: 6.46 (164) Overall OD: 3.56 (91) End 1 ID: 1.84 (47)	ST1061	HYDAC 160D025W, HYDAC 301410 This product is not available in all regions of the world Overall Height: 5.12 (130) Overall OD: 2.36 (60) End 1 ID: 1.30 (33)
ST1044	HYDAC 160D010BH3HC, HYDAC 308088 This product is not available in all regions of the world Overall Height: 4.57 (116) Overall OD: 2.72 (69) End 1 ID: 1.31 (33)	ST1053	HYDAC 330D020BH3HC, HYDAC 308095 This product is not available in all regions of the world Overall Height: 6.46 (164) Overall OD: 3.56 (91) End 1 ID: 1.84 (47)	ST1062	HYDAC 240D025W, HYDAC 303875 This product is not available in all regions of the world Overall Height: 7.44 (189) Overall OD: 2.36 (60) End 1 ID: 1.30 (33)
ST1045	HYDAC 160D020BH3HC, HYDAC 308087 This product is not available in all regions of the world Overall Height: 4.57 (116) Overall OD: 2.72 (69) End 1 ID: 1.31 (33)	ST1054	HYDAC 660D003BH3HC, HYDAC 308102 This product is not available in all regions of the world Overall Height: 12.95 (329) Overall OD: 3.56 (91) End 1 ID: 1.84 (47)	ST1063	HYDAC 330D025W, HYDAC 301411 This product is not available in all regions of the world. Overall Height: 7.09 (180) Overall OD: 3.01 (77) End 1 ID: 1.84 (47)

E. PRODUCT GUIDE

<p>ST1064 HYDAC 660D025W, HYDAC 301412 This product is not available in all regions of the world.</p> <p>Overall Height: 13.82 (351) Overall OD: 3.01 (77) End 1 ID: 1.84 (47)</p>	<p>ST1073 HYDAC 110D020V, HYDAC 303997 This product is not available in all regions of the world.</p> <p>Overall Height: 6.22 (158) Overall OD: 1.75 (45) End 1 ID: 0.83 (21)</p>	<p>ST1082 HYDAC 240D010V, HYDAC 303873 This product is not available in all regions of the world.</p> <p>Overall Height: 7.44 (189) Overall OD: 2.36 (60) End 1 ID: 1.30 (33)</p>
<p>ST1065 HYDAC 30D020V, HYDAC 30D010V, HYDAC 303969 This product is not available in all regions of the world.</p> <p>Overall Height: 3.70 (94) Overall OD: 1.38 (35) End 1 ID: 0.45 (11)</p>	<p>ST1074 HYDAC 110D010V, HYDAC 303998 This product is not available in all regions of the world.</p> <p>Overall Height: 6.22 (158) Overall OD: 1.75 (45) End 1 ID: 0.83 (21)</p>	<p>ST1083 HYDAC 240D005V, HYDAC 303872 This product is not available in all regions of the world.</p> <p>Overall Height: 7.44 (189) Overall OD: 2.36 (60) End 1 ID: 1.30 (33)</p>
<p>ST1066 HYDAC 303970 This product is not available in all regions of the world.</p> <p>Overall Height: 3.70 (94) Overall OD: 1.38 (35) End 1 ID: 0.45 (11)</p>	<p>ST1075 HYDAC 110D005V, HYDAC 303999 This product is not available in all regions of the world.</p> <p>Overall Height: 6.22 (158) Overall OD: 1.75 (45) End 1 ID: 0.83 (21)</p>	<p>ST1084 HYDAC 240D003V, HYDAC 303871 This product is not available in all regions of the world.</p> <p>Overall Height: 7.44 (189) Overall OD: 2.36 (60) End 1 ID: 1.30 (33)</p>
<p>ST1067 HYDAC 30D005V, HYDAC 303971 This product is not available in all regions of the world.</p> <p>Overall Height: 3.70 (94) Overall OD: 1.38 (35) End 1 ID: 0.45 (11)</p>	<p>ST1076 HYDAC 110D003V, HYDAC 304001 This product is not available in all regions of the world.</p> <p>Overall Height: 6.22 (158) Overall OD: 1.75 (45) End 1 ID: 0.83 (21)</p>	<p>ST1085 HYDAC 330D020V, HYDAC 245413 This product is not available in all regions of the world.</p> <p>Overall Height: 7.09 (180) Overall OD: 3.01 (77) End 1 ID: 1.84 (47)</p>
<p>ST1068 HYDAC 30D003V, HYDAC 303972 This product is not available in all regions of the world.</p> <p>Overall Height: 3.70 (94) Overall OD: 1.38 (35) End 1 ID: 0.45 (11)</p>	<p>ST1077 HYDAC 160D020V, HYDAC 245412 This product is not available in all regions of the world.</p> <p>Overall Height: 5.12 (130) Overall OD: 2.36 (60) End 1 ID: 1.30 (33)</p>	<p>ST1086 HYDAC 330D010V, HYDAC 245403 This product is not available in all regions of the world.</p> <p>Overall Height: 7.09 (180) Overall OD: 3.01 (77) End 1 ID: 1.84 (47)</p>
<p>ST1069 HYDAC 60D010V, HYDAC 60D020V, HYDAC 245411 This product is not available in all regions of the world.</p> <p>Overall Height: 3.58 (91) Overall OD: 1.75 (45) End 1 ID: 0.83 (21)</p>	<p>ST1078 HYDAC 160D010V, HYDAC 245402 This product is not available in all regions of the world.</p> <p>Overall Height: 5.12 (130) Overall OD: 2.36 (60) End 1 ID: 1.30 (33)</p>	<p>ST1087 HYDAC 330D005V, HYDAC 245107 This product is not available in all regions of the world.</p> <p>Overall Height: 7.09 (180) Overall OD: 3.01 (77) End 1 ID: 1.84 (47)</p>
<p>ST1070 HYDAC 245401 This product is not available in all regions of the world.</p> <p>Overall Height: 3.58 (91) Overall OD: 1.75 (45) End 1 ID: 0.83 (21)</p>	<p>ST1079 HYDAC 160D005V, HYDAC 245106 This product is not available in all regions of the world.</p> <p>Overall Height: 5.12 (130) Overall OD: 2.36 (60) End 1 ID: 1.30 (33)</p>	<p>ST1088 HYDAC 330D003V, HYDAC 245102 This product is not available in all regions of the world.</p> <p>Overall Height: 7.09 (180) Overall OD: 3.01 (77) End 1 ID: 1.84 (47)</p>
<p>ST1071 HYDAC 60D005V, HYDAC 245105 This product is not available in all regions of the world.</p> <p>Overall Height: 3.58 (91) Overall OD: 1.75 (45) End 1 ID: 0.83 (21)</p>	<p>ST1080 HYDAC 160D003V, HYDAC 245101 This product is not available in all regions of the world.</p> <p>Overall Height: 5.12 (130) Overall OD: 2.36 (60) End 1 ID: 1.30 (33)</p>	<p>ST1089 HYDAC 660D020V, HYDAC 302808 This product is not available in all regions of the world.</p> <p>Overall Height: 13.82 (351) Overall OD: 3.01 (77) End 1 ID: 1.84 (47)</p>
<p>ST1072 HYDAC 60D003V, HYDAC 245100 This product is not available in all regions of the world.</p> <p>Overall Height: 3.58 (91) Overall OD: 1.75 (45) End 1 ID: 0.83 (21)</p>	<p>ST1081 HYDAC 240D020V, HYDAC 303874 This product is not available in all regions of the world.</p> <p>Overall Height: 7.44 (189) Overall OD: 2.36 (60) End 1 ID: 1.30 (33)</p>	<p>ST1090 HYDAC 660D010V, HYDAC 301357 This product is not available in all regions of the world.</p> <p>Overall Height: 13.82 (351) Overall OD: 3.01 (77) End 1 ID: 1.84 (47)</p>

E. PRODUCT GUIDE

ST1091 HYDAC 660D005V, HYDAC 301359 This product is not available in all regions of the world. Overall Height: 13.82 (351) Overall OD: 3.01 (77) End 1 ID: 1.84 (47)	ST1100 HYDAC 660R025W This product is not available in all regions of the world. Overall Height: 13.15 (334) Overall OD: 3.76 (96) BPV Setting: 43.51 (300) End 1 ID: 2.63 (67)	ST1109 HYDAC 60R020V This product is not available in all regions of the world. Overall Height: 4.06 (103) Overall OD: 1.75 (45) BPV Setting: 43.51 (300) End 1 ID: 0.83 (21)
ST1092 HYDAC 660D003V, HYDAC 301360 This product is not available in all regions of the world. Overall Height: 13.82 (351) Overall OD: 3.01 (77) End 1 ID: 1.84 (47)	ST1101 HYDAC 850R025W This product is not available in all regions of the world. Overall Height: 16.30 (414) Overall OD: 3.76 (96) BPV Setting: 43.51 (300) End 1 ID: 2.63 (67)	ST1110 HYDAC 60R010V This product is not available in all regions of the world. Overall Height: 4.06 (103) Overall OD: 1.75 (45) BPV Setting: 43.51 (300) End 1 ID: 0.83 (21)
ST1093 HYDAC 30R025W This product is not available in all regions of the world. Overall Height: 4.13 (105) Overall OD: 1.38 (35) BPV Setting: 43.51 (300) End 1 ID: 0.45 (11)	ST1102 HYDAC 950R025W This product is not available in all regions of the world. Overall Height: 16.30 (414) Overall OD: 3.76 (96) BPV Setting: 43.51 (300) End 1 ID: 2.63 (67)	ST1111 HYDAC 60R005V This product is not available in all regions of the world. Overall Height: 4.06 (103) Overall OD: 1.75 (45) BPV Setting: 43.51 (300) End 1 ID: 0.83 (21)
ST1094 HYDAC 60R025W This product is not available in all regions of the world. Overall Height: 4.06 (103) Overall OD: 1.75 (45) BPV Setting: 43.51 (300) End 1 ID: 0.83 (21)	ST1103 HYDAC 1300R025W This product is not available in all regions of the world. Overall Height: 14.33 (364) Overall OD: 4.90 (125) BPV Setting: 43.51 (300) End 1 ID: 3.78 (96)	ST1112 HYDAC 60R003V This product is not available in all regions of the world. Overall Height: 4.06 (103) Overall OD: 1.75 (45) BPV Setting: 43.51 (300) End 1 ID: 0.83 (21)
ST1095 HYDAC 110R025W This product is not available in all regions of the world. Overall Height: 6.69 (170) Overall OD: 1.75 (45) BPV Setting: 43.51 (300) End 1 ID: 0.83 (21)	ST1104 HYDAC 2600R025W This product is not available in all regions of the world. Overall Height: 19.02 (483) Overall OD: 4.90 (125) BPV Setting: 43.51 (300) End 1 ID: 3.78 (96)	ST1113 HYDAC 110R020V This product is not available in all regions of the world. Overall Height: 6.69 (170) Overall OD: 1.75 (45) BPV Setting: 43.51 (300) End 1 ID: 0.83 (21)
ST1096 HYDAC 160R025W This product is not available in all regions of the world. Overall Height: 5.67 (144) Overall OD: 2.36 (60) BPV Setting: 43.51 (300) End 1 ID: 1.27 (32)	ST1105 HYDAC 30R020V This product is not available in all regions of the world. Overall Height: 4.13 (105) Overall OD: 1.38 (35) BPV Setting: 43.51 (300) End 1 ID: 0.45 (11)	ST1114 HYDAC 110R010V This product is not available in all regions of the world. Overall Height: 6.69 (170) Overall OD: 1.75 (45) BPV Setting: 43.51 (300) End 1 ID: 0.83 (21)
ST1097 HYDAC 240R025W This product is not available in all regions of the world. Overall Height: 7.99 (203) Overall OD: 2.36 (60) BPV Setting: 43.51 (300) End 1 ID: 1.27 (32)	ST1106 HYDAC 30R010V This product is not available in all regions of the world. Overall Height: 4.13 (105) Overall OD: 1.38 (35) BPV Setting: 43.51 (300) End 1 ID: 0.45 (11)	ST1115 HYDAC 110R005V This product is not available in all regions of the world. Overall Height: 6.69 (170) Overall OD: 1.75 (45) BPV Setting: 43.51 (300) End 1 ID: 0.83 (21)
ST1098 HYDAC 330R025W This product is not available in all regions of the world. Overall Height: 7.68 (195) Overall OD: 3.01 (77) BPV Setting: 43.51 (300) End 1 ID: 1.84 (47)	ST1107 HYDAC 30R005V This product is not available in all regions of the world. Overall Height: 4.13 (105) Overall OD: 1.38 (35) BPV Setting: 43.51 (300) End 1 ID: 0.45 (11)	ST1116 HYDAC 110R003V This product is not available in all regions of the world. Overall Height: 6.69 (170) Overall OD: 1.75 (45) BPV Setting: 43.51 (300) End 1 ID: 0.83 (21)
ST1099 HYDAC 500R025W This product is not available in all regions of the world. Overall Height: 10.87 (276) Overall OD: 3.01 (77) BPV Setting: 43.51 (300) End 1 ID: 1.84 (47)	ST1108 HYDAC 30R003V This product is not available in all regions of the world. Overall Height: 4.13 (105) Overall OD: 1.38 (35) BPV Setting: 43.51 (300) End 1 ID: 0.45 (11)	ST1117 HYDAC 160R020V This product is not available in all regions of the world. Overall Height: 5.67 (144) Overall OD: 2.36 (60) BPV Setting: 43.51 (300) End 1 ID: 1.27 (32)

E. PRODUCT GUIDE

<p>ST1118 HYDAC 160R010V This product is not available in all regions of the world.</p> <p>Overall Height: 5.67 (144) Overall OD: 2.36 (60) BPV Setting: 43.51 (300) End 1 ID: 1.27 (32)</p>	<p>ST1127 HYDAC 330R005V This product is not available in all regions of the world.</p> <p>Overall Height: 7.68 (195) Overall OD: 3.01 (77) BPV Setting: 43.51 (300) End 1 ID: 1.84 (47)</p>	<p>ST1136 HYDAC 660R003V This product is not available in all regions of the world.</p> <p>Overall Height: 13.15 (334) Overall OD: 3.76 (96) BPV Setting: 43.51 (300) End 1 ID: 2.63 (67)</p>
<p>ST1119 HYDAC 160R005V This product is not available in all regions of the world.</p> <p>Overall Height: 5.67 (144) Overall OD: 2.36 (60) BPV Setting: 43.51 (300) End 1 ID: 1.27 (32)</p>	<p>ST1128 HYDAC 330R003V This product is not available in all regions of the world.</p> <p>Overall Height: 7.68 (195) Overall OD: 3.01 (77) BPV Setting: 43.51 (300) End 1 ID: 1.84 (47)</p>	<p>ST1137 HYDAC 850R020V This product is not available in all regions of the world.</p> <p>Overall Height: 16.30 (414) Overall OD: 3.76 (96) BPV Setting: 43.51 (300) End 1 ID: 2.63 (67)</p>
<p>ST1120 HYDAC 160R003V This product is not available in all regions of the world.</p> <p>Overall Height: 5.67 (144) Overall OD: 2.36 (60) BPV Setting: 43.51 (300) End 1 ID: 1.27 (32)</p>	<p>ST1129 HYDAC 500R020V This product is not available in all regions of the world.</p> <p>Overall Height: 10.87 (276) Overall OD: 3.01 (77) BPV Setting: 43.51 (300) End 1 ID: 1.84 (47)</p>	<p>ST1138 HYDAC 850R010V This product is not available in all regions of the world.</p> <p>Overall Height: 16.30 (414) Overall OD: 3.76 (96) BPV Setting: 43.51 (300) End 1 ID: 2.63 (67)</p>
<p>ST1121 HYDAC 240R020V This product is not available in all regions of the world.</p> <p>Overall Height: 7.99 (203) Overall OD: 2.36 (60) BPV Setting: 43.51 (300) End 1 ID: 1.27 (32)</p>	<p>ST1130 HYDAC 500R010V This product is not available in all regions of the world.</p> <p>Overall Height: 10.87 (276) Overall OD: 3.01 (77) BPV Setting: 43.51 (300) End 1 ID: 1.84 (47)</p>	<p>ST1139 HYDAC 850R005V This product is not available in all regions of the world.</p> <p>Overall Height: 16.30 (414) Overall OD: 3.76 (96) BPV Setting: 43.51 (300) End 1 ID: 2.63 (67)</p>
<p>ST1122 HYDAC 240R010V This product is not available in all regions of the world.</p> <p>Overall Height: 7.99 (203) Overall OD: 2.36 (60) BPV Setting: 43.51 (300) End 1 ID: 1.27 (32)</p>	<p>ST1131 HYDAC 500R005V This product is not available in all regions of the world.</p> <p>Overall Height: 10.87 (276) Overall OD: 3.01 (77) BPV Setting: 43.51 (300) End 1 ID: 1.84 (47)</p>	<p>ST1140 HYDAC 850R003V This product is not available in all regions of the world.</p> <p>Overall Height: 16.30 (414) Overall OD: 3.76 (96) BPV Setting: 43.51 (300) End 1 ID: 2.63 (67)</p>
<p>ST1123 HYDAC 240R005V This product is not available in all regions of the world.</p> <p>Overall Height: 7.99 (203) Overall OD: 2.36 (60) BPV Setting: 43.51 (300) End 1 ID: 1.27 (32)</p>	<p>ST1132 HYDAC 500R003V This product is not available in all regions of the world.</p> <p>Overall Height: 10.87 (276) Overall OD: 3.01 (77) BPV Setting: 43.51 (300) End 1 ID: 1.84 (47)</p>	<p>ST1141 HYDAC 950R020V This product is not available in all regions of the world.</p> <p>Overall Height: 14.33 (364) Overall OD: 4.90 (125) BPV Setting: 43.51 (300) End 1 ID: 3.78 (96)</p>
<p>ST1124 HYDAC 240R003V This product is not available in all regions of the world.</p> <p>Overall Height: 7.99 (203) Overall OD: 2.36 (60) BPV Setting: 43.51 (300) End 1 ID: 1.27 (32)</p>	<p>ST1133 HYDAC 660R020V This product is not available in all regions of the world.</p> <p>Overall Height: 13.15 (334) Overall OD: 3.76 (96) BPV Setting: 43.51 (300) End 1 ID: 2.63 (67)</p>	<p>ST1142 HYDAC 950R010V This product is not available in all regions of the world.</p> <p>Overall Height: 14.33 (364) Overall OD: 4.90 (125) BPV Setting: 43.51 (300) End 1 ID: 3.78 (96)</p>
<p>ST1125 HYDAC 330R020V This product is not available in all regions of the world.</p> <p>Overall Height: 7.68 (195) Overall OD: 3.01 (77) BPV Setting: 43.51 (300) End 1 ID: 1.84 (47)</p>	<p>ST1134 HYDAC 660R010V This product is not available in all regions of the world.</p> <p>Overall Height: 13.15 (334) Overall OD: 3.76 (96) BPV Setting: 43.51 (300) End 1 ID: 2.63 (67)</p>	<p>ST1143 HYDAC 950R005V This product is not available in all regions of the world.</p> <p>Overall Height: 14.33 (364) Overall OD: 4.90 (125) BPV Setting: 43.51 (300) End 1 ID: 3.78 (96)</p>
<p>ST1126 HYDAC 330R010V This product is not available in all regions of the world.</p> <p>Overall Height: 7.68 (195) Overall OD: 3.01 (77) BPV Setting: 43.51 (300) End 1 ID: 1.84 (47)</p>	<p>ST1135 HYDAC 660R005V This product is not available in all regions of the world.</p> <p>Overall Height: 13.15 (334) Overall OD: 3.76 (96) BPV Setting: 43.51 (300) End 1 ID: 2.63 (67)</p>	<p>ST1144 HYDAC 950R003V This product is not available in all regions of the world.</p> <p>Overall Height: 14.33 (364) Overall OD: 4.90 (125) BPV Setting: 43.51 (300) End 1 ID: 3.78 (96)</p>

E. PRODUCT GUIDE

ST1145	HYDAC 1300R020V This product is not available in all regions of the world. Overall Height: 19.02 (483) Overall OD: 4.90 (125) BPV Setting: 43.51 (300) End 1 ID: 3.78 (96)	ST1154	HYDAC 850R010BN3HC This product is not available in all regions of the world. Overall Height: 16.30 (414) Overall OD: 4.49 (114) BPV Setting: 43.51 (300) End 1 ID: 2.69 (68)	ST1163	HYDAC 1300R005BN3HC This product is not available in all regions of the world. Overall Height: 19.02 (483) Overall OD: 5.63 (143) BPV Setting: 43.51 (300) End 1 ID: 3.78 (96)
ST1146	HYDAC 1300R010V This product is not available in all regions of the world. Overall Height: 19.02 (483) Overall OD: 4.90 (125) BPV Setting: 43.51 (300) End 1 ID: 3.78 (96)	ST1155	HYDAC 850R005BN3HC This product is not available in all regions of the world. Overall Height: 16.30 (414) Overall OD: 4.49 (114) BPV Setting: 43.51 (300) End 1 ID: 2.69 (68)	ST1164	HYDAC 1300R003BN3HC This product is not available in all regions of the world. Overall Height: 19.02 (483) Overall OD: 5.63 (143) BPV Setting: 43.51 (300) End 1 ID: 3.78 (96)
ST1147	HYDAC 1300R005V This product is not available in all regions of the world. Overall Height: 19.02 (483) Overall OD: 4.90 (125) BPV Setting: 43.51 (300) End 1 ID: 3.78 (96)	ST1156	HYDAC 850R003BN3HC This product is not available in all regions of the world. Overall Height: 16.30 (414) Overall OD: 4.49 (114) BPV Setting: 43.51 (300) End 1 ID: 2.69 (68)	ST1167	MAHLE PI3245SMXVST10 This product is not available in all regions of the world. Overall Height: 14.69 (373) Overall OD: 3.25 (83) End 1 ID: 1.87 (48)
ST1148	HYDAC 1300R003V This product is not available in all regions of the world. Overall Height: 19.02 (483) Overall OD: 4.90 (125) BPV Setting: 43.51 (300) End 1 ID: 3.78 (96)	ST1157	HYDAC 950R020BN3HC This product is not available in all regions of the world. Overall Height: 14.33 (364) Overall OD: 5.63 (143) BPV Setting: 43.51 (300) End 1 ID: 3.78 (96)	ST1206	INTERNORMEN 1E32010VG16SP This product is not available in all regions of the world. Overall Height: 12.21 (310) Overall OD: 2.76 (70) BPV Setting: 36.26 (250) End 1 ID: 1.63 (42)
ST1149	HYDAC 2600R020BN3HC This product is not available in all regions of the world. Overall Height: 36.30 (922) Overall OD: 5.63 (143) BPV Setting: 43.51 (300) End 1 ID: 3.78 (96)	ST1158	HYDAC 950R010BN3HC This product is not available in all regions of the world. Overall Height: 14.33 (364) Overall OD: 5.63 (143) BPV Setting: 43.51 (300) End 1 ID: 3.78 (96)	ST1207	INTERNORMEN 1E42516VG16SP This product is not available in all regions of the world. Overall Height: 12.24 (311) Overall OD: 3.27 (83) BPV Setting: 36.26 (250) End 1 ID: 1.77 (45)
ST1150	HYDAC 2600R010V This product is not available in all regions of the world. Overall Height: 36.30 (922) Overall OD: 4.90 (125) BPV Setting: 43.51 (300) End 1 ID: 3.78 (96)	ST1159	HYDAC 950R005BN3HC This product is not available in all regions of the world. Overall Height: 14.33 (364) Overall OD: 5.63 (143) BPV Setting: 43.51 (300) End 1 ID: 3.78 (96)	ST1208	MP FILTRI HP1352A10AN This product is not available in all regions of the world. Overall Height: 9.06 (230) Overall OD: 2.13 (54) End 1 ID: 1.02 (26)
ST1151	HYDAC 2600R005V This product is not available in all regions of the world. Overall Height: 36.30 (922) Overall OD: 4.90 (125) BPV Setting: 43.51 (300) End 1 ID: 3.78 (96)	ST1160	HYDAC 950R003BN3HC This product is not available in all regions of the world. Overall Height: 14.33 (364) Overall OD: 5.63 (143) BPV Setting: 43.51 (300) End 1 ID: 3.78 (96)	ST1211	MP FILTRI HP1352A25AN This product is not available in all regions of the world. Overall Height: 9.06 (230) Overall OD: 2.13 (54) End 1 ID: 1.02 (26)
ST1152	HYDAC 2600R003V This product is not available in all regions of the world. Overall Height: 36.30 (922) Overall OD: 4.90 (125) BPV Setting: 43.51 (300) End 1 ID: 3.78 (96)	ST1161	HYDAC 1300R020BN3HC This product is not available in all regions of the world. Overall Height: 19.02 (483) Overall OD: 5.63 (143) BPV Setting: 43.51 (300) End 1 ID: 3.78 (96)	ST1215	HYDAC 30D003BN3HC, HYDAC 305158 This product is not available in all regions of the world. Overall Height: 3.70 (94) Overall OD: 1.38 (35) End 1 ID: 0.45 (11)
ST1153	HYDAC 850R020BN3HC This product is not available in all regions of the world. Overall Height: 16.30 (414) Overall OD: 4.49 (114) BPV Setting: 43.51 (300) End 1 ID: 2.69 (68)	ST1162	HYDAC 1300R010BN3HC This product is not available in all regions of the world. Overall Height: 19.02 (483) Overall OD: 5.63 (143) BPV Setting: 43.51 (300) End 1 ID: 3.78 (96)	ST1216	HYDAC 30D005BN3HC, HYDAC 305521 This product is not available in all regions of the world. Overall Height: 3.70 (94) Overall OD: 1.38 (35) End 1 ID: 0.45 (11)

E. PRODUCT GUIDE

<p>ST1217 HYDAC 30D010BN3HC, HYDAC 1250149, HYDAC 1250486 This product is not available in all regions of the world.</p> <p>Overall Height: 3.70 (94) Overall OD: 1.38 (35) End 1 ID: 0.45 (11)</p>	<p>ST1227 HYDAC 160D003BN3HC, HYDAC 308114 This product is not available in all regions of the world.</p> <p>Overall Height: 4.57 (116) Overall OD: 2.72 (69) End 1 ID: 1.31 (33)</p>	<p>ST1236 HYDAC 330D005BN3HC, HYDAC 1260897, HYDAC 308121 This product is not available in all regions of the world.</p> <p>Overall Height: 6.46 (164) Overall OD: 3.56 (91) End 1 ID: 1.84 (47)</p>
<p>ST1219 HYDAC 60D003BN3HC, HYDAC 308106 This product is not available in all regions of the world.</p> <p>Overall Height: 3.31 (84) Overall OD: 1.85 (47) End 1 ID: 0.83 (21)</p>	<p>ST1228 HYDAC 160D005BN3HC, HYDAC 308113 This product is not available in all regions of the world.</p> <p>Overall Height: 4.57 (116) Overall OD: 2.72 (69) End 1 ID: 1.31 (33)</p>	<p>ST1237 HYDAC 330D010BN3HC, HYDAC 1250493, HYDAC 308120 This product is not available in all regions of the world.</p> <p>Overall Height: 6.46 (164) Overall OD: 3.56 (91) End 1 ID: 1.84 (47)</p>
<p>ST1220 HYDAC 60D005BN3HC, HYDAC 308105, HYDAC 1253040 This product is not available in all regions of the world.</p> <p>Overall Height: 3.31 (84) Overall OD: 1.85 (47) End 1 ID: 0.83 (21)</p>	<p>ST1229 HYDAC 160D010BN3HC, HYDAC 308112 This product is not available in all regions of the world.</p> <p>Overall Height: 4.57 (116) Overall OD: 2.72 (69) End 1 ID: 1.31 (33)</p>	<p>ST1238 HYDAC 330D020BN3HC, HYDAC 308119 This product is not available in all regions of the world.</p> <p>Overall Height: 6.46 (164) Overall OD: 3.56 (91) End 1 ID: 1.84 (47)</p>
<p>ST1221 HYDAC 60D010BN3HC, HYDAC 1250487, HYDAC 308104 This product is not available in all regions of the world.</p> <p>Overall Height: 3.31 (84) Overall OD: 1.85 (47) End 1 ID: 0.83 (21)</p>	<p>ST1230 HYDAC 160D020BN3HC, HYDAC 308111 This product is not available in all regions of the world.</p> <p>Overall Height: 4.57 (116) Overall OD: 2.72 (69) End 1 ID: 1.31 (33)</p>	<p>ST1239 HYDAC 500D003BN3HC, HYDAC 314953 This product is not available in all regions of the world.</p> <p>Overall Height: 9.96 (253) Overall OD: 3.56 (91) End 1 ID: 1.84 (47)</p>
<p>ST1222 This product is not available in all regions of the world.</p> <p>Overall Height: 3.31 (84) Overall OD: 1.85 (47) End 1 ID: 0.83 (21)</p>	<p>ST1231 HYDAC 240D003BN3HC, HYDAC 308118 This product is not available in all regions of the world.</p> <p>Overall Height: 6.89 (175) Overall OD: 2.72 (69) End 1 ID: 1.31 (33)</p>	<p>ST1240 HYDAC 500D005BN3HC, HYDAC 309512 This product is not available in all regions of the world.</p> <p>Overall Height: 9.96 (253) Overall OD: 3.56 (91) End 1 ID: 1.84 (47)</p>
<p>ST1223 HYDAC 110D003BN3HC This product is not available in all regions of the world.</p> <p>Overall Height: 6.02 (153) Overall OD: 1.85 (47) End 1 ID: 0.83 (21)</p>	<p>ST1232 HYDAC 240D005BN3HC, HYDAC 308117 This product is not available in all regions of the world.</p> <p>Overall Height: 6.89 (175) Overall OD: 2.72 (69) End 1 ID: 1.31 (33)</p>	<p>ST1241 HYDAC 500D010BN3HC, HYDAC 1250494, HYDAC 309510 This product is not available in all regions of the world.</p> <p>Overall Height: 9.96 (253) Overall OD: 3.56 (91) End 1 ID: 1.84 (47)</p>
<p>ST1224 HYDAC 110D005BN3HC, HYDAC 308110 This product is not available in all regions of the world.</p> <p>Overall Height: 6.02 (153) Overall OD: 1.85 (47) End 1 ID: 0.83 (21)</p>	<p>ST1233 HYDAC 240D010BN3HC, HYDAC 1250491, HYDAC 308116 This product is not available in all regions of the world.</p> <p>Overall Height: 6.89 (175) Overall OD: 2.72 (69) End 1 ID: 1.31 (33)</p>	<p>ST1242 HYDAC 500D020BN3HC, HYDAC 308960 This product is not available in all regions of the world.</p> <p>Overall Height: 9.96 (253) Overall OD: 3.56 (91) End 1 ID: 1.84 (47)</p>
<p>ST1225 HYDAC 308108 This product is not available in all regions of the world.</p> <p>Overall Height: 6.02 (153) Overall OD: 1.85 (47) End 1 ID: 0.83 (21)</p>	<p>ST1234 HYDAC 240D020BN3HC, HYDAC 308115 This product is not available in all regions of the world.</p> <p>Overall Height: 6.89 (175) Overall OD: 2.72 (69) End 1 ID: 1.31 (33)</p>	<p>ST1243 HYDAC 660D003BN3HC, HYDAC 308126 This product is not available in all regions of the world.</p> <p>Overall Height: 12.95 (329) Overall OD: 3.56 (91) End 1 ID: 1.84 (47)</p>
<p>ST1226 HYDAC 110D020BN3HC, HYDAC 308107 This product is not available in all regions of the world.</p> <p>Overall Height: 6.02 (153) Overall OD: 1.85 (47) End 1 ID: 0.83 (21)</p>	<p>ST1235 HYDAC 330D003BN3HC, HYDAC 308122 This product is not available in all regions of the world.</p> <p>Overall Height: 6.46 (164) Overall OD: 3.56 (91) End 1 ID: 1.84 (47)</p>	<p>ST1244 HYDAC 660D005BN3HC, HYDAC 308125 This product is not available in all regions of the world.</p> <p>Overall Height: 12.95 (329) Overall OD: 3.56 (91) End 1 ID: 1.84 (47)</p>

E. PRODUCT GUIDE

ST1245	HYDAC 660D010BN3HC, HYDAC 308124 This product is not available in all regions of the world. Overall Height: 12.95 (329) Overall OD: 3.56 (91) End 1 ID: 1.84 (47)	ST1254	HYDAC 110R020BN3HC, HYDAC 304085 This product is not available in all regions of the world. Overall Height: 6.69 (170) Overall OD: 2.03 (52) BPV Setting: 43.51 (300) End 1 ID: 0.87 (22)	ST1263	HYDAC 330R003BN3HC This product is not available in all regions of the world. Overall Height: 7.68 (195) Overall OD: 3.74 (95) BPV Setting: 43.51 (300) End This product is not available in all regions of the world.1 ID: 1.91 (49)
ST1246	HYDAC 660D020BN3HC, HYDAC 308123 This product is not available in all regions of the world. Overall Height: 12.95 (329) Overall OD: 3.56 (91) End 1 ID: 1.84 (47)	ST1255	HYDAC 160R003BN3HC This product is not available in all regions of the world. Overall Height: 5.67 (144) Overall OD: 2.91 (74) BPV Setting: 43.51 (300) End 1 ID: 1.35 (34)	ST1264	HYDAC 330R005BN3HC This product is not available in all regions of the world. Overall Height: 7.68 (195) Overall OD: 3.74 (95) BPV Setting: 43.51 (300) End 1 ID: 1.91 (49)
ST1247	HYDAC 60R003BN3HC This product is not available in all regions of the world. Overall Height: 4.06 (103) Overall OD: 2.03 (52) BPV Setting: 43.51 (300) End 1 ID: 0.87 (22)	ST1256	HYDAC 160R005BN3HC This product is not available in all regions of the world. Overall Height: 5.67 (144) Overall OD: 2.91 (74) BPV Setting: 43.51 (300) End 1 ID: 1.35 (34)	ST1265	HYDAC 330R010BN3HC, HYDAC 1262993 This product is not available in all regions of the world. Overall Height: 7.68 (195) Overall OD: 3.74 (95) BPV Setting: 43.51 (300) End 1 ID: 1.91 (49)
ST1248	HYDAC 60R005BN3HC This product is not available in all regions of the world. Overall Height: 4.06 (103) Overall OD: 2.03 (52) BPV Setting: 43.51 (300) End 1 ID: 0.87 (22)	ST1257	HYDAC 160R010BN3HC This product is not available in all regions of the world. Overall Height: 5.67 (144) Overall OD: 2.91 (74) BPV Setting: 43.51 (300) End 1 ID: 1.35 (34)	ST1266	HYDAC 330R020BN3HC, HYDAC 245602 This product is not available in all regions of the world. Overall Height: 7.68 (195) Overall OD: 3.74 (95) BPV Setting: 43.51 (300) End 1 ID: 1.91 (49)
ST1249	HYDAC 60R010BN3HC This product is not available in all regions of the world. Overall Height: 4.06 (103) Overall OD: 2.03 (52) BPV Setting: 43.51 (300) End 1 ID: 0.87 (22)	ST1258	HYDAC 160R020BN3HC This product is not available in all regions of the world. Overall Height: 5.67 (144) Overall OD: 2.91 (74) BPV Setting: 43.51 (300) End 1 ID: 1.35 (34)	ST1267	HYDAC 500R003BN3HC This product is not available in all regions of the world. Overall Height: 10.87 (276) Overall OD: 3.74 (95) BPV Setting: 43.51 (300) End 1 ID: 1.91 (49)
ST1250	HYDAC 60R020BN3HC This product is not available in all regions of the world. Overall Height: 4.06 (103) Overall OD: 2.03 (52) BPV Setting: 43.51 (300) End 1 ID: 0.87 (22)	ST1259	HYDAC 240R003BN3HC This product is not available in all regions of the world. Overall Height: 7.99 (203) Overall OD: 2.91 (74) BPV Setting: 43.51 (300) End 1 ID: 1.35 (34)	ST1268	HYDAC 500R005BN3HC This product is not available in all regions of the world. Overall Height: 10.87 (276) Overall OD: 3.74 (95) BPV Setting: 43.51 (300) End 1 ID: 1.91 (49)
ST1251	HYDAC 110R003BN3HC This product is not available in all regions of the world. Overall Height: 6.69 (170) Overall OD: 2.03 (52) BPV Setting: 43.51 (300) End 1 ID: 0.87 (22)	ST1260	HYDAC 240R005BN3HC This product is not available in all regions of the world. Overall Height: 7.99 (203) Overall OD: 2.91 (74) BPV Setting: 43.51 (300) End 1 ID: 1.35 (34)	ST1269	HYDAC 500R010BN3HC This product is not available in all regions of the world. Overall Height: 10.87 (276) Overall OD: 3.74 (95) BPV Setting: 43.51 (300) End 1 ID: 1.91 (49)
ST1252	HYDAC 110R005BN3HC This product is not available in all regions of the world. Overall Height: 6.69 (170) Overall OD: 2.03 (52) BPV Setting: 43.51 (300) End 1 ID: 0.87 (22)	ST1261	HYDAC 240R010BN3HC This product is not available in all regions of the world. Overall Height: 7.99 (203) Overall OD: 2.91 (74) BPV Setting: 43.51 (300) End 1 ID: 1.35 (34)	ST1270	HYDAC 500R020BN3HC This product is not available in all regions of the world. Overall Height: 10.87 (276) Overall OD: 3.74 (95) BPV Setting: 43.51 (300) End 1 ID: 1.91 (49)
ST1253	HYDAC 1262945 This product is not available in all regions of the world. Overall Height: 6.69 (170) Overall OD: 2.03 (52) BPV Setting: 43.51 (300) End 1 ID: 0.87 (22)	ST1262	HYDAC 240R020BN3HC This product is not available in all regions of the world. Overall Height: 7.99 (203) Overall OD: 2.91 (74) BPV Setting: 43.51 (300) End 1 ID: 1.35 (34)	ST1271	HYDAC 660R003BN3HC This product is not available in all regions of the world. Overall Height: 13.15 (334) Overall OD: 4.49 (114) BPV Setting: 43.51 (300) End 1 ID: 2.69 (68)

E. PRODUCT GUIDE

<p>ST1272 HYDAC 660R005BN3HC This product is not available in all regions of the world.</p> <p>Overall Height: 13.15 (334) Overall OD: 4.49 (114) BPV Setting: 43.51 (300) End 1 ID: 2.69 (68)</p>	<p>ST1282 HYDAC 330D100W This product is not available in all regions of the world.</p> <p>Overall Height: 7.09 (180) Overall OD: 3.01 (77) End 1 ID: 1.84 (47)</p>	<p>ST1292 HYDAC 30R010BN3HC This product is not available in all regions of the world.</p> <p>Overall Height: 4.13 (105) Overall OD: 1.38 (35) BPV Setting: 43.51 (300) End 1 ID: 0.45 (11)</p>
<p>ST1273 HYDAC 660R010BN3HC This product is not available in all regions of the world.</p> <p>Overall Height: 13.15 (334) Overall OD: 4.49 (114) BPV Setting: 43.51 (300) End 1 ID: 2.69 (68)</p>	<p>ST1283 HYDAC 660D40W This product is not available in all regions of the world.</p> <p>Overall Height: 13.82 (351) Overall OD: 3.01 (77) End 1 ID: 1.84 (47)</p>	<p>ST1293 HYDAC 30R020BN3HC This product is not available in all regions of the world.</p> <p>Overall Height: 4.13 (105) Overall OD: 1.38 (35) BPV Setting: 43.51 (300) End 1 ID: 0.45 (11)</p>
<p>ST1274 HYDAC 660R020BN3HC, HYDAC 1263018 This product is not available in all regions of the world.</p> <p>Overall Height: 13.15 (334) Overall OD: 4.49 (114) BPV Setting: 43.51 (300) End 1 ID: 2.69 (68)</p>	<p>ST1284 HYDAC 660D100W This product is not available in all regions of the world.</p> <p>Overall Height: 13.82 (351) Overall OD: 3.01 (77) End 1 ID: 1.84 (47)</p>	<p>ST1294 HYDAC 140D003BH3HC, HYDAC 311178 This product is not available in all regions of the world.</p> <p>Overall Height: 7.60 (193) Overall OD: 1.85 (47) End 1 ID: 0.83 (21)</p>
<p>ST1275 HYDAC 260R003BN3HC This product is not available in all regions of the world.</p> <p>Overall Height: 36.30 (922) Overall OD: 5.63 (143) BPV Setting: 43.51 (300) End 1 ID: 3.78 (96)</p>	<p>ST1285 HYDAC 140D010BN3HC This product is not available in all regions of the world.</p> <p>Overall Height: 7.60 (193) Overall OD: 1.85 (47) End 1 ID: 0.83 (21)</p>	<p>ST1295 HYDAC 140D005BH3HC, HYDAC 308860 This product is not available in all regions of the world.</p> <p>Overall Height: 7.60 (193) Overall OD: 1.85 (47) End 1 ID: 0.83 (21)</p>
<p>ST1276 HYDAC 260R005BN3HC This product is not available in all regions of the world.</p> <p>Overall Height: 36.30 (922) Overall OD: 5.63 (143) BPV Setting: 43.51 (300) End 1 ID: 3.78 (96)</p>	<p>ST1286 HYDAC 480R010BN3HC This product is not available in all regions of the world.</p> <p>Overall Height: 15.16 (385) Overall OD: 2.91 (74) BPV Setting: 43.51 (300) End 1 ID: 1.35 (34)</p>	<p>ST1296 HYDAC 140D010BH3HC, HYDAC 309501 This product is not available in all regions of the world.</p> <p>Overall Height: 7.60 (193) Overall OD: 1.85 (47) End 1 ID: 0.83 (21)</p>
<p>ST1277 HYDAC 260R010BN3HC, HYDAC 1263065 This product is not available in all regions of the world.</p> <p>Overall Height: 36.30 (922) Overall OD: 5.63 (143) BPV Setting: 43.51 (300) End 1 ID: 3.78 (96)</p>	<p>ST1287 HYDAC 140D025W This product is not available in all regions of the world.</p> <p>Overall Height: 7.87 (200) Overall OD: 1.75 (45) End 1 ID: 0.83 (21)</p>	<p>ST1298 HYDAC 140D003V This product is not available in all regions of the world.</p> <p>Overall Height: 7.87 (200) Overall OD: 1.75 (45) End 1 ID: 0.83 (21)</p>
<p>ST1279 HYDAC 240D040W, HYDAC 306928 This product is not available in all regions of the world.</p> <p>Overall Height: 7.44 (189) Overall OD: 2.36 (60) End 1 ID: 1.30 (33)</p>	<p>ST1288 HYDAC 280D025W, HYDAC 313257 This product is not available in all regions of the world.</p> <p>Overall Height: 14.61 (371) Overall OD: 2.36 (60) End 1 ID: 1.30 (33)</p>	<p>ST1299 HYDAC 140D005V, HYDAC 314339 This product is not available in all regions of the world.</p> <p>Overall Height: 7.87 (200) Overall OD: 1.75 (45) End 1 ID: 0.83 (21)</p>
<p>ST1280 HYDAC 240D100W This product is not available in all regions of the world.</p> <p>Overall Height: 7.44 (189) Overall OD: 2.36 (60) End 1 ID: 1.30 (33)</p>	<p>ST1289 HYDAC 500D025W, HYDAC 313004 This product is not available in all regions of the world.</p> <p>Overall Height: 10.75 (273) Overall OD: 3.01 (77) End 1 ID: 1.84 (47)</p>	<p>ST1300 HYDAC 140D010V, HYDAC 313186 This product is not available in all regions of the world.</p> <p>Overall Height: 7.87 (200) Overall OD: 1.75 (45) End 1 ID: 0.83 (21)</p>
<p>ST1281 HYDAC 330D40W This product is not available in all regions of the world.</p> <p>Overall Height: 7.09 (180) Overall OD: 3.01 (77) End 1 ID: 1.84 (47)</p>	<p>ST1290 HYDAC 30R003BN3HC This product is not available in all regions of the world.</p> <p>Overall Height: 4.13 (105) Overall OD: 1.38 (35) BPV Setting: 43.51 (300) End 1 ID: 0.45 (11)</p>	<p>ST1301 HYDAC 140D020V, HYDAC 313187 This product is not available in all regions of the world.</p> <p>Overall Height: 7.87 (200) Overall OD: 1.75 (45) End 1 ID: 0.83 (21)</p>
	<p>ST1291 HYDAC 30R005BN3HC This product is not available in all regions of the world.</p> <p>Overall Height: 4.13 (105) Overall OD: 1.38 (35) BPV Setting: 43.51 (300) End 1 ID: 0.45 (11)</p>	

E. PRODUCT GUIDE

ST1302	HYDAC 280D003V This product is not available in all regions of the world. Overall Height: 14.61 (371) Overall OD: 2.36 (60) End 1 ID: 1.30 (33)	ST1312	HYDAC 500D005BH3HC, HYDAC 309511 This product is not available in all regions of the world. Overall Height: 9.96 (253) Overall OD: 3.56 (91) End 1 ID: 1.84 (47)	ST1331	MAHLE 852754MIC10 This product is not available in all regions of the world. Overall Height: 19.02 (483) Overall OD: 4.00 (102) End 1 ID: 2.42 (62)
ST1303	HYDAC 280D005V This product is not available in all regions of the world. Overall Height: 14.61 (371) Overall OD: 2.36 (60) End 1 ID: 1.30 (33)	ST1313	HYDAC 500D003BH3HC, HYDAC 312422 This product is not available in all regions of the world. Overall Height: 9.96 (253) Overall OD: 3.56 (91) End 1 ID: 1.84 (47)	ST1333	HYDAC 165R020BN3HC This product is not available in all regions of the world. Overall Height: 8.98 (228) Overall OD: 2.36 (60) BPV Setting: 43.51 (300) End 1 ID: 1.27 (32)
ST1304	HYDAC 280D010V This product is not available in all regions of the world. Overall Height: 14.61 (371) Overall OD: 2.36 (60) End 1 ID: 1.30 (33)	ST1314	HYDAC 500D020BH3HC, HYDAC 309508 This product is not available in all regions of the world. Overall Height: 9.96 (253) Overall OD: 3.56 (91) End 1 ID: 1.84 (47)	ST1337	HYDAC 60D100W This product is not available in all regions of the world. Overall Height: 3.58 (91) Overall OD: 1.75 (45) End 1 ID: 0.83 (21)
ST1305	HYDAC 280D020V, HYDAC 313188 This product is not available in all regions of the world. Overall Height: 14.61 (371) Overall OD: 2.36 (60) End 1 ID: 1.30 (33)	ST1315	HYDAC 2600R010BN3HCB6 This product is not available in all regions of the world. Overall Height: 36.30 (922) Overall OD: 5.63 (143) BPV Setting: 87.02 (600) End 1 ID: 3.78 (96)	ST1339	MAHLE 852754MIC25 This product is not available in all regions of the world. Overall Height: 19.02 (483) Overall OD: 4.02 (102) End 1 ID: 2.42 (62)
ST1306	HYDAC 500D003V, HYDAC 312858 This product is not available in all regions of the world. Overall Height: 10.75 (273) Overall OD: 3.01 (77) End 1 ID: 1.84 (47)	ST1316	HYDAC 2600R020BN3HCB6 This product is not available in all regions of the world. Overall Height: 36.30 (922) Overall OD: 5.63 (143) BPV Setting: 87.02 (600) End 1 ID: 3.78 (96)	ST1340	This product is not available in all regions of the world. Overall Height: 8.86 (225) Overall OD: 3.62 (92) End 1 ID: 0.45 (12) End 2 ID: 2.52 (64)
ST1307	HYDAC 500D005V, HYDAC 314341 This product is not available in all regions of the world. Overall Height: 10.75 (273) Overall OD: 3.01 (77) End 1 ID: 1.84 (47)	ST1317	HYDAC 850R020BN3HCB6 This product is not available in all regions of the world. Overall Height: 16.30 (414) Overall OD: 4.49 (114) BPV Setting: 87.02 (600) End 1 ID: 2.69 (68)	ST1342	MAHLE 852126SMX25 This product is not available in all regions of the world. Overall Height: 4.43 (113) End 1 OD: 1.79 (46) End 2 OD: 1.77 (45) End 1 ID: 1.01 (26)
ST1308	HYDAC 500D010V, HYDAC 313374 This product is not available in all regions of the world. Overall Height: 10.75 (273) Overall OD: 3.01 (77) End 1 ID: 1.84 (47)	ST1318	EPPENSTEINER 2225P25P This product is not available in all regions of the world.	ST1343	MAHLE 852127SMX25 This product is not available in all regions of the world. Overall Height: 6.95 (177) Overall OD: 2.03 (52) End 1 ID: 1.22 (31)
ST1309	HYDAC 500D020V This product is not available in all regions of the world. Overall Height: 10.75 (273) Overall OD: 3.01 (77) End 1 ID: 1.84 (47)	ST1319	HYDAC 2600R020V This product is not available in all regions of the world. Overall Height: 36.30 (922) Overall OD: 4.90 (125) BPV Setting: 43.51 (300) End 1 ID: 3.78 (96)	ST1352	DOMANGE FD66P10 This product is not available in all regions of the world. Overall Height: 13.78 (350) Overall OD: 4.96 (126) End 1 ID: 0.45 (12) End 2 ID: 3.62 (92)
ST1310	HYDAC 500D010BH3HC, HYDAC 309509 This product is not available in all regions of the world. Overall Height: 9.96 (253) Overall OD: 3.56 (91) End 1 ID: 1.84 (47)	ST1320	HYDAC 30D003BH3HC, HYDAC 305123 This product is not available in all regions of the world. Overall Height: 3.70 (94) Overall OD: 1.38 (35) End 1 ID: 0.45 (11)	ST1355	MAHLE PI1030MIC25 This product is not available in all regions of the world. Overall Height: 10.12 (257) Overall OD: 3.25 (83) End 1 ID: 1.87 (48)
ST1311	HYDAC 140D020BH3HC, HYDAC 309500 This product is not available in all regions of the world. Overall Height: 7.60 (193) Overall OD: 1.85 (47) End 1 ID: 0.83 (21)	ST1321	HYDAC 30D005BH3HC, HYDAC 322694 This product is not available in all regions of the world. Overall Height: 3.70 (94) Overall OD: 1.38 (35) End 1 ID: 0.45 (11)	ST1356	MAHLE 852493MIC10 This product is not available in all regions of the world. Overall Height: 3.62 (92) Overall OD: 1.65 (42) End 1 ID: 0.83 (21) End 2 ID: 0.83 (21)

E. PRODUCT GUIDE

ST1357 MAHLE 852493MIC25 This product is not available in all regions of the world. Overall Height: 3.60 (92) Overall OD: 1.65 (42) End 1 ID: 0.84 (21) End 2 ID: 0.84 (21)	ST1366 MAHLE 852436MIC10 This product is not available in all regions of the world. Overall Height: 12.52 (318) Overall OD: 5.08 (129) End 1 ID: 2.60 (66) End 2 ID: 2.74 (70)	ST1376 MAHLE 852127MICVST10 This product is not available in all regions of the world. Overall Height: 6.97 (177) Overall OD: 2.03 (52) End 1 ID: 1.20 (31)
ST1358 MAHLE 852443MIC10 This product is not available in all regions of the world. Overall Height: 4.11 (105) Overall OD: 2.28 (58) End 1 ID: 1.21 (31) End 2 ID: 0.81 (21)	ST1367 MAHLE 852436MIC25 This product is not available in all regions of the world. Overall Height: 12.52 (318) Overall OD: 5.08 (129) End 1 ID: 2.60 (66) End 2 ID: 2.74 (70)	ST1377 MAHLE 852126DRGVST60 This product is not available in all regions of the world. Overall Height: 4.43 (113) Overall OD: 1.77 (45) End 1 ID: 1.00 (25)
ST1359 MAHLE 852444MIC25 This product is not available in all regions of the world. Overall Height: 4.11 (105) Overall OD: 2.28 (58) End 1 ID: 1.21 (31) End 2 ID: 0.81 (21)	ST1368 MAHLE 852439DRG25 This product is not available in all regions of the world. Overall Height: 8.58 (218) Overall OD: 3.90 (99) End 1 ID: 1.91 (49) End 2 ID: 2.05 (52)	ST1378 MAHLE 852362MICVST10 This product is not available in all regions of the world. Overall Height: 5.08 (129) Overall OD: 3.23 (82) End 1 ID: 1.28 (33) End 2 ID: 1.28 (33)
ST1360 MAHLE 852444MIC25 This product is not available in all regions of the world. Overall Height: 7.01 (178) Overall OD: 2.28 (58) End 1 ID: 1.21 (31) End 2 ID: 0.81 (21)	ST1369 MAHLE 852444SMX25 This product is not available in all regions of the world. Overall Height: 7.07 (180) Overall OD: 2.28 (58) End 1 ID: 1.27 (32) End 2 ID: 0.83 (21)	ST1398MR UCCHYDR UC270113 pressure gauge This product is not available in all regions of the world.
ST1361 MAHLE 852438MIC10 This product is not available in all regions of the world. Overall Height: 6.08 (155) Overall OD: 3.92 (100) End 1 ID: 1.89 (48) End 2 ID: 1.98 (50)	ST1370 MAHLE 852125DRG25 This product is not available in all regions of the world. Overall Height: 3.37 (86) Overall OD: 1.63 (42) End 1 ID: 0.84 (21)	ST1400 MAHLE 852436SMX10 This product is not available in all regions of the world. Overall Height: 12.60 (320) Overall OD: 5.08 (129) End 1 ID: 2.63 (67) End 2 ID: 2.78 (71)
ST1362 MAHLE 852439MIC10 This product is not available in all regions of the world. Overall Height: 8.56 (218) Overall OD: 3.92 (100) End 1 ID: 1.89 (48) End 2 ID: 1.98 (50)	ST1371 MAHLE 852126DRG60 This product is not available in all regions of the world. Overall Height: 4.43 (113) Overall OD: 1.79 (46) End 1 ID: 0.95 (24)	ST1402 PARKER GO1930Q This product is not available in all regions of the world. Overall Height: 5.34 (136) Overall OD: 2.36 (60) End 1 ID: 0.98 (25)
ST1363 MAHLE 852439MIC25 This product is not available in all regions of the world. Overall Height: 8.56 (218) Overall OD: 3.92 (100) End 1 ID: 1.89 (48) End 2 ID: 1.98 (50)	ST1372 MAHLE 852034DRG60 This product is not available in all regions of the world. Overall Height: 5.67 (144) Overall OD: 3.05 (78) End 1 ID: 1.08 (28)	ST1404 MAHLE 852760SMX10 This product is not available in all regions of the world. Overall Height: 16.69 (424) Overall OD: 5.51 (140) End 1 ID: 2.56 (65) End 2 ID: 2.56 (65)
ST1364 MAHLE 852435MIC10 This product is not available in all regions of the world. Overall Height: 8.70 (221) Overall OD: 5.08 (129) End 1 ID: 2.62 (67) End 2 ID: 2.74 (70)	ST1373 EPPENSTEINER 1820P102 Overall Height: 3.43 (87) Overall OD: 1.63 (42) End 1 ID: 0.84 (21)	ST1405 MAHLE PI3105SMX10 This product is not available in all regions of the world. Overall Height: 3.70 (94) Overall OD: 1.85 (47) End 1 ID: 1.00 (26)
ST1365 MAHLE 852435MIC25 This product is not available in all regions of the world. Overall Height: 8.70 (221) Overall OD: 5.08 (129) End 1 ID: 2.62 (67) End 2 ID: 2.74 (70)	ST1374 EPPENSTEINER 1840P102 This product is not available in all regions of the world. Overall Height: 4.45 (113) Overall OD: 1.75 (45) End 1 ID: 0.95 (24)	ST1406 MAHLE PI3108SMX10 This product is not available in all regions of the world. Overall Height: 6.77 (172) Overall OD: 1.85 (47) End 1 ID: 1.00 (26)
	ST1375 MAHLE 852126MICVST10 This product is not available in all regions of the world. Overall Height: 4.45 (113) Overall OD: 1.75 (45) End 1 ID: 0.95 (24)	ST1407 MAHLE PI3111SMX10 This product is not available in all regions of the world. Overall Height: 9.80 (249) Overall OD: 1.85 (47) End 1 ID: 1.00 (26)

E. PRODUCT GUIDE

ST1408	MAHLE PI3115SMX10 This product is not available in all regions of the world. Overall Height: 5.59 (142) Overall OD: 3.25 (83) End 1 ID: 1.87 (48)	ST1424	MAHLE PI2105SMX3 This product is not available in all regions of the world. Overall Height: 3.70 (94) Overall OD: 1.85 (47) End 1 ID: 1.00 (26)	ST1436	HYDAC 280D020BN3HC, HYDAC 309505 This product is not available in all regions of the world. Overall Height: 14.02 (356) Overall OD: 2.72 (69) End 1 ID: 1.31 (33)
ST1409	MAHLE PI3130SMX10 This product is not available in all regions of the world. Overall Height: 10.12 (257) Overall OD: 3.25 (83) End 1 ID: 1.87 (48)	ST1426	UCC HYDRAULICS UC2439 This product is not available in all regions of the world. Overall Height: 5.87 (149) Largest OD: 3.78 (96) BPV Setting: 14.50 (100) Thread Size: 3/4-14 BSP	ST1437	HYDAC 280D003BH3HC, HYDAC 310536 This product is not available in all regions of the world. Overall Height: 14.02 (356) Overall OD: 2.72 (69) End 1 ID: 1.31 (33)
ST1410	MAHLE PI3145SMX10 This product is not available in all regions of the world. Overall Height: 14.69 (373) Overall OD: 3.25 (83) End 1 ID: 1.87 (48)	ST1427	UCC HYDRAULICS UC2449 This product is not available in all regions of the world. Overall Height: 7.13 (181) Largest OD: 5.04 (128) BPV Setting: 14.50 (100) Thread Size: 1 1/4 BSP	ST1438	HYDAC 280D005BH3HC, HYDAC 308321 This product is not available in all regions of the world. Overall Height: 14.02 (356) Overall OD: 2.72 (69) End 1 ID: 1.31 (33)
ST1411	MAHLE PI3205SMXVST10 This product is not available in all regions of the world. Overall Height: 3.70 (94) Overall OD: 1.85 (47) End 1 ID: 1.00 (26)	ST1428	INTERNORMEN 1E7010P16SP This product is not available in all regions of the world. Overall Height: 6.65 (169) Overall OD: 1.77 (45) BPV Setting: 29.01 (200) End 1 ID: 0.91 (23)	ST1439	HYDAC 280D010BH3HC This product is not available in all regions of the world. Overall Height: 14.02 (356) Overall OD: 2.72 (69) End 1 ID: 1.31 (33)
ST1412	MAHLE PI3208SMXVST10 This product is not available in all regions of the world. Overall Height: 6.77 (172) Overall OD: 1.85 (47) End 1 ID: 1.00 (26)	ST1429MA	pressure gauge This product is not available in all regions of the world.	ST1440	HYDAC 280D020BH3HC, HYDAC 309506, HYDAC 311324 This product is not available in all regions of the world. Overall Height: 14.02 (356) Overall OD: 2.72 (69) End 1 ID: 1.31 (33)
ST1413	MAHLE PI3211SMXVST10 This product is not available in all regions of the world. Overall Height: 9.80 (249) Overall OD: 1.85 (47) End 1 ID: 1.00 (26)	ST1430	MAHLE PI2230SMXVST3 This product is not available in all regions of the world. Overall Height: 10.12 (257) Overall OD: 3.25 (83) End 1 ID: 1.87 (48)	ST1441	HYDAC 110R025WHC This product is not available in all regions of the world. Overall Height: 6.69 (170) Overall OD: 2.03 (52) BPV Setting: 43.51 (300) End 1 ID: 0.87 (22)
ST1414	MAHLE PI3215SMXVST10 This product is not available in all regions of the world. Overall Height: 5.59 (142) Overall OD: 3.25 (83) End 1 ID: 1.87 (48)	ST1432	TEHO FILTER KOVL9625 This product is not available in all regions of the world. Overall Height: 5.91 (150) Overall OD: 2.87 (73) End 1 ID: 1.10 (28)	ST1442	HYDAC 330R100WHC This product is not available in all regions of the world. Overall Height: 7.68 (195) Overall OD: 3.74 (95) BPV Setting: 43.51 (300) End 1 ID: 1.91 (49)
ST1415	MAHLE PI3230SMXVST10 This product is not available in all regions of the world. Overall Height: 10.12 (257) Overall OD: 3.25 (83) End 1 ID: 1.87 (48)	ST1433	HYDAC 280D003BN3HC, HYDAC 311967 This product is not available in all regions of the world. Overall Height: 14.02 (356) Overall OD: 2.72 (69) End 1 ID: 1.31 (33)	ST1445	MAHLE 852087SMX25 This product is not available in all regions of the world. Overall Height: 7.56 (192) Overall OD: 6.30 (160) End 1 ID: 4.33 (110) End 2 ID: 4.33 (110)
ST1422	MAHLE HC18 This product is not available in all regions of the world. Overall Height: 7.09 (180) Largest OD: 5.04 (128) Thread Size: 1 1/2-16 UNF-2B	ST1434	HYDAC 280D005BN3HC, HYDAC 310535 This product is not available in all regions of the world. Overall Height: 14.02 (356) Overall OD: 2.72 (69) End 1 ID: 1.31 (33)	ST1446	MAHLE 852125SMXVST25 This product is not available in all regions of the world. Overall Height: 3.41 (87) Overall OD: 1.63 (42) End 1 ID: 0.89 (23)
ST1423	MP FILTRI HP3203A25AN This product is not available in all regions of the world. Overall Height: 14.74 (375) Overall OD: 3.07 (78) End 1 ID: 1.52 (39)	ST1435	HYDAC 280D010BN3HC, HYDAC 308672 This product is not available in all regions of the world. Overall Height: 14.02 (356) Overall OD: 2.72 (69) End 1 ID: 1.31 (33)		

E. PRODUCT GUIDE

<p>ST1447 MAHLE 852439SMX10 This product is not available in all regions of the world.</p> <p>Overall Height: 8.58 (218) Overall OD: 3.90 (99) End 1 ID: 1.91 (49) End 2 ID: 2.09 (53)</p>	<p>ST1457 MAHLE PI4145SMX25 This product is not available in all regions of the world.</p> <p>Overall Height: 14.69 (373) Overall OD: 3.25 (83) End 1 ID: 1.87 (48)</p>	<p>ST1466 HYDAC 160R100WHC This product is not available in all regions of the world.</p> <p>Overall Height: 5.67 (144) Overall OD: 2.91 (74) BPV Setting: 43.51 (300) End 1 ID: 1.35 (34)</p>
<p>ST1448 MAHLE PI1008MIC25 This product is not available in all regions of the world.</p> <p>Overall Height: 6.73 (171) Overall OD: 1.85 (47) End 1 ID: 1.00 (26)</p>	<p>ST1458 MAHLE PI9408DRGVST60 This product is not available in all regions of the world.</p> <p>Overall Height: 6.77 (172) Overall OD: 1.85 (47) End 1 ID: 1.00 (26)</p>	<p>ST1467 HYDAC 240R025WHC This product is not available in all regions of the world.</p> <p>Overall Height: 7.99 (203) Overall OD: 2.91 (74) BPV Setting: 43.51 (300) End 1 ID: 1.35 (34)</p>
<p>ST1449 MAHLE PI1015MIC25 This product is not available in all regions of the world.</p> <p>Overall Height: 5.63 (143) Overall OD: 3.25 (83) End 1 ID: 1.87 (48)</p>	<p>ST1459 HYDAC 60R025WHC This product is not available in all regions of the world.</p> <p>Overall Height: 4.06 (103) Overall OD: 2.03 (52) BPV Setting: 43.51 (300) End 1 ID: 0.87 (22)</p>	<p>ST1468 HYDAC 240R050WHC This product is not available in all regions of the world.</p> <p>Overall Height: 7.99 (203) Overall OD: 2.91 (74) BPV Setting: 43.51 (300) End 1 ID: 1.35 (34)</p>
<p>ST1450 MAHLE PI1105MIC10 This product is not available in all regions of the world.</p> <p>Overall Height: 3.66 (93) Overall OD: 1.85 (47) End 1 ID: 1.00 (26)</p>	<p>ST1460 HYDAC 60R050WHC This product is not available in all regions of the world.</p> <p>Overall Height: 4.06 (103) Overall OD: 2.03 (52) BPV Setting: 43.51 (300) End 1 ID: 0.87 (22)</p>	<p>ST1469 HYDAC 240R100WHC This product is not available in all regions of the world.</p> <p>Overall Height: 7.99 (203) Overall OD: 2.91 (74) BPV Setting: 43.51 (300) End 1 ID: 1.35 (34)</p>
<p>ST1451 MAHLE PI1108MIC10 This product is not available in all regions of the world.</p> <p>Overall Height: 6.73 (171) Overall OD: 1.85 (47) End 1 ID: 1.00 (26)</p>	<p>ST1461 HYDAC 60R100WHC This product is not available in all regions of the world.</p> <p>Overall Height: 4.06 (103) Overall OD: 2.03 (52) BPV Setting: 43.51 (300) End 1 ID: 0.87 (22)</p>	<p>ST1470 HYDAC 330R025WHC This product is not available in all regions of the world.</p> <p>Overall Height: 7.68 (195) Overall OD: 3.74 (95) BPV Setting: 43.51 (300) End 1 ID: 1.91 (49)</p>
<p>ST1452 MAHLE PI2108SMX3 This product is not available in all regions of the world.</p> <p>Overall Height: 6.77 (172) Overall OD: 1.85 (47) End 1 ID: 1.00 (26)</p>	<p>ST1462 HYDAC 110R050WHC This product is not available in all regions of the world.</p> <p>Overall Height: 6.69 (170) Overall OD: 2.03 (52) BPV Setting: 43.51 (300) End 1 ID: 0.87 (22)</p>	<p>ST1471 HYDAC 330R050WHC This product is not available in all regions of the world.</p> <p>Overall Height: 7.68 (195) Overall OD: 3.74 (95) BPV Setting: 43.51 (300) End 1 ID: 1.91 (49)</p>
<p>ST1453 MAHLE PI2111SMX3 This product is not available in all regions of the world.</p> <p>Overall Height: 9.80 (249) Overall OD: 1.85 (47) End 1 ID: 1.00 (26)</p>	<p>ST1463 HYDAC 110R100WHC This product is not available in all regions of the world.</p> <p>Overall Height: 6.69 (170) Overall OD: 2.03 (52) BPV Setting: 43.51 (300) End 1 ID: 0.87 (22)</p>	<p>ST1472 HYDAC 500R025WHC This product is not available in all regions of the world.</p> <p>Overall Height: 10.87 (276) Overall OD: 3.74 (95) BPV Setting: 43.51 (300) End 1 ID: 1.91 (49)</p>
<p>ST1454 MAHLE PI2145SMX3 This product is not available in all regions of the world.</p> <p>Overall Height: 14.69 (373) Overall OD: 3.25 (83) End 1 ID: 1.87 (48)</p>	<p>ST1464 HYDAC 160R025WHC This product is not available in all regions of the world.</p> <p>Overall Height: 5.67 (144) Overall OD: 2.91 (74) BPV Setting: 43.51 (300) End 1 ID: 1.35 (34)</p>	<p>ST1473 HYDAC 500R050WHC This product is not available in all regions of the world.</p> <p>Overall Height: 10.87 (276) Overall OD: 3.74 (95) BPV Setting: 43.51 (300) End 1 ID: 1.91 (49)</p>
<p>ST1455 MAHLE PI2245SMXVST3 This product is not available in all regions of the world.</p> <p>Overall Height: 14.69 (373) Overall OD: 3.25 (83) End 1 ID: 1.87 (48)</p>	<p>ST1465 HYDAC 160R050WHC This product is not available in all regions of the world.</p> <p>Overall Height: 5.67 (144) Overall OD: 2.91 (74) BPV Setting: 43.51 (300) End 1 ID: 1.35 (34)</p>	<p>ST1474 HYDAC 500R100WHC This product is not available in all regions of the world.</p> <p>Overall Height: 10.87 (276) Overall OD: 3.74 (95) BPV Setting: 43.51 (300) End 1 ID: 1.91 (49)</p>
<p>ST1456 MAHLE PI4108SMX25 This product is not available in all regions of the world.</p> <p>Overall Height: 6.77 (172) Overall OD: 1.85 (47) End 1 ID: 1.00 (26)</p>		

E. PRODUCT GUIDE

ST1475	HYDAC 660R025WHC This product is not available in all regions of the world. Overall Height: 13.15 (334) Overall OD: 4.49 (114) BPV Setting: 43.51 (300) End 1 ID: 2.69 (68)	ST1484	HYDAC 1300R025WHC This product is not available in all regions of the world. Overall Height: 19.02 (483) Overall OD: 5.63 (143) BPV Setting: 43.51 (300) End 1 ID: 3.78 (96)	ST1493	EPPENSTEINER 190G25 This product is not available in all regions of the world. Overall Height: 5.63 (143) Overall OD: 2.09 (53) End 1 ID: 1.01 (26) End 2 ID: 1.29 (33)
ST1476	HYDAC 660R050WHC This product is not available in all regions of the world. Overall Height: 13.15 (334) Overall OD: 4.49 (114) BPV Setting: 43.51 (300) End 1 ID: 2.69 (68)	ST1485	HYDAC 1300R050WHC This product is not available in all regions of the world. Overall Height: 19.02 (483) Overall OD: 5.63 (143) BPV Setting: 43.51 (300) End 1 ID: 3.78 (96)	ST1494	EPPENSTEINER 290G25 This product is not available in all regions of the world. Overall Height: 5.95 (151) Overall OD: 2.11 (54) End 1 ID: 0.92 (23)
ST1477	HYDAC 660R100WHC This product is not available in all regions of the world. Overall Height: 13.15 (334) Overall OD: 4.49 (114) BPV Setting: 43.51 (300) End 1 ID: 2.69 (68)	ST1486	HYDAC 1300R100WHC This product is not available in all regions of the world. Overall Height: 19.02 (483) Overall OD: 5.63 (143) BPV Setting: 43.51 (300) End 1 ID: 3.78 (96)	ST1495	EPPENSTEINER 256G25 This product is not available in all regions of the world. Overall Height: 3.76 (96) Overall OD: 2.11 (54) End 1 ID: 0.92 (23)
ST1478	HYDAC 850R025WHC This product is not available in all regions of the world. Overall Height: 16.30 (414) Overall OD: 4.49 (114) BPV Setting: 43.51 (300) End 1 ID: 2.69 (68)	ST1487	HYDAC 2600R025WHC This product is not available in all regions of the world. Overall Height: 36.30 (922) Overall OD: 5.63 (143) BPV Setting: 43.51 (300) End 1 ID: 3.78 (96)	ST1496	EPPENSTEINER 2140G25 This product is not available in all regions of the world. Overall Height: 5.95 (151) Overall OD: 2.91 (74) End 1 ID: 1.56 (40)
ST1479	HYDAC 850R050WHC This product is not available in all regions of the world. Overall Height: 16.30 (414) Overall OD: 4.49 (114) BPV Setting: 43.51 (300) End 1 ID: 2.69 (68)	ST1488	HYDAC 2600R050WHC This product is not available in all regions of the world. Overall Height: 36.30 (922) Overall OD: 5.63 (143) BPV Setting: 43.51 (300) End 1 ID: 3.78 (96)	ST1497	MAHLE 852761SMX10 This product is not available in all regions of the world. Overall Height: 33.39 (848) Overall OD: 5.51 (140) End 1 ID: 2.56 (65) End 2 ID: 2.56 (65)
ST1480	HYDAC 850R100WHC This product is not available in all regions of the world. Overall Height: 16.30 (414) Overall OD: 4.49 (114) BPV Setting: 43.51 (300) End 1 ID: 2.69 (68)	ST1489	HYDAC 2600R100WHC This product is not available in all regions of the world. Overall Height: 36.30 (922) Overall OD: 5.63 (143) BPV Setting: 43.51 (300) End 1 ID: 3.78 (96)	ST1498	MAHLE 852127SMX10 This product is not available in all regions of the world. Overall Height: 6.95 (177) Overall OD: 2.03 (52) End 1 ID: 1.22 (31)
ST1481	HYDAC 950R025WHC This product is not available in all regions of the world. Overall Height: 14.33 (364) Overall OD: 5.63 (143) BPV Setting: 43.51 (300) End 1 ID: 3.78 (96)	ST1490	MAHLE HC28 This product is not available in all regions of the world. Overall Height: 6.73 (171) Largest OD: 5.45 (139) Thread Size: 1 1/2-16 UNF-2B	ST1503	MAHLE 852438SMX10 This product is not available in all regions of the world. Overall Height: 6.14 (156) Overall OD: 3.90 (99) End 1 ID: 1.91 (49) End 2 ID: 2.09 (53)
ST1482	HYDAC 950R050WHC This product is not available in all regions of the world. Overall Height: 14.33 (364) Overall OD: 5.63 (143) BPV Setting: 43.51 (300) End 1 ID: 3.78 (96)	ST1491	MAHLE PI8330DRG40 This product is not available in all regions of the world. Overall Height: 14.06 (357) Overall OD: 3.25 (83) End 1 ID: 1.87 (48)	ST1504	MAHLE 852438SMX25 This product is not available in all regions of the world. Overall Height: 6.14 (156) Overall OD: 3.90 (99) End 1 ID: 1.91 (49) End 2 ID: 2.09 (53)
ST1483	HYDAC 950R100WHC This product is not available in all regions of the world. Overall Height: 14.33 (364) Overall OD: 5.63 (143) BPV Setting: 43.51 (300) End 1 ID: 3.78 (96)	ST1492	MAHLE PI8508DRG100 This product is not available in all regions of the world. Overall Height: 6.77 (172) Overall OD: 1.85 (47) End 1 ID: 1.00 (26)	ST1505	MAHLE PI4130SMX25 This product is not available in all regions of the world. Overall Height: 10.12 (257) Overall OD: 3.25 (83) End 1 ID: 1.87 (48)
				ST1506	EPPENSTEINER 2225G25 This product is not available in all regions of the world. Overall Height: 8.90 (226) Overall OD: 2.91 (74) End 1 ID: 1.56 (40)

E. PRODUCT GUIDE

ST1507	EPPENSTEINER 2460H10LL This product is not available in all regions of the world. Overall Height: 14.84 (377) Overall OD: 2.91 (74) End 1 ID: 1.56 (40)	ST1518	MAHLE PI2205SMXVST3 This product is not available in all regions of the world. Overall Height: 3.70 (94) Overall OD: 1.85 (47) End 1 ID: 1.00 (26)	ST1528	MAHLE PI4245SMXVST25 This product is not available in all regions of the world. Overall Height: 14.69 (373) Overall OD: 3.25 (83) End 1 ID: 1.87 (48)
ST1508	EPPENSTEINER 2460H20LL This product is not available in all regions of the world. Overall Height: 14.84 (377) Overall OD: 2.91 (74) End 1 ID: 1.56 (40)	ST1519	MAHLE PI2208SMXVST3 This product is not available in all regions of the world. Overall Height: 6.77 (172) Overall OD: 1.85 (47) End 1 ID: 1.00 (26)	ST1529	MAHLE PI5105SMX6 This product is not available in all regions of the world. Overall Height: 3.70 (94) Overall OD: 1.85 (47) End 1 ID: 1.00 (26)
ST1509	EPPENSTEINER 2460H10LL2 This product is not available in all regions of the world. Overall Height: 14.84 (377) Overall OD: 2.91 (74) End 1 ID: 1.56 (40)	ST1520	MAHLE PI2211SMXVST3 This product is not available in all regions of the world. Overall Height: 9.80 (249) Overall OD: 1.85 (47) End 1 ID: 1.00 (26)	ST1530	MAHLE PI5108SMX6 This product is not available in all regions of the world. Overall Height: 6.77 (172) Overall OD: 1.85 (47) End 1 ID: 1.00 (26)
ST1510	EPPENSTEINER 2460H20LL2 This product is not available in all regions of the world. Overall Height: 14.84 (377) Overall OD: 2.91 (74) End 1 ID: 1.56 (40)	ST1521	MAHLE PI2215SMXVST3 This product is not available in all regions of the world. Overall Height: 5.59 (142) Overall OD: 3.25 (83) End 1 ID: 1.87 (48)	ST1531	MAHLE PI5111SMX6 This product is not available in all regions of the world. Overall Height: 9.80 (249) Overall OD: 1.85 (47) End 1 ID: 1.00 (26)
ST1512	MAHLE PI4115SMX25 This product is not available in all regions of the world. Overall Height: 5.59 (142) Overall OD: 3.25 (83) End 1 ID: 1.87 (48)	ST1522	MAHLE PI4105SMX25 This product is not available in all regions of the world. Overall Height: 3.70 (94) Overall OD: 1.85 (47) End 1 ID: 1.00 (26)	ST1532	MAHLE PI5115SMX6 This product is not available in all regions of the world. Overall Height: 5.59 (142) Overall OD: 3.25 (83) End 1 ID: 1.87 (48)
ST1513	MAHLE 852127MICVST25 This product is not available in all regions of the world. Overall Height: 6.97 (177) Overall OD: 2.03 (52) End 1 ID: 1.20 (31)	ST1523	MAHLE PI4205SMXVST25 This product is not available in all regions of the world. Overall Height: 3.70 (94) Overall OD: 1.85 (47) End 1 ID: 1.00 (26)	ST1533	MAHLE PI5130SMX6 This product is not available in all regions of the world. Overall Height: 10.12 (257) Overall OD: 3.25 (83) End 1 ID: 1.87 (48)
ST1514	MAHLE 852443SMX10 This product is not available in all regions of the world. Overall Height: 4.11 (105) Overall OD: 2.28 (58) End 1 ID: 1.27 (32) End 2 ID: 0.83 (21)	ST1524	MAHLE PI4208SMXVST25 This product is not available in all regions of the world. Overall Height: 6.77 (172) Overall OD: 1.85 (47) End 1 ID: 1.00 (26)	ST1534	MAHLE PI5145SMX6 This product is not available in all regions of the world. Overall Height: 14.69 (373) Overall OD: 3.25 (83) End 1 ID: 1.87 (48)
ST1515	MAHLE PI4111SMX25 This product is not available in all regions of the world. Overall Height: 9.80 (249) Overall OD: 1.85 (47) End 1 ID: 1.00 (26)	ST1525	MAHLE PI4211SMXVST25 This product is not available in all regions of the world. Overall Height: 9.80 (249) Overall OD: 1.85 (47) End 1 ID: 1.00 (26)	ST1537IC	restriction indicator This product is not available in all regions of the world.
ST1516	MAHLE PI2115SMX3 This product is not available in all regions of the world. Overall Height: 5.59 (142) Overall OD: 3.25 (83) End 1 ID: 1.87 (48)	ST1526	MAHLE PI4215SMXVST25 This product is not available in all regions of the world. Overall Height: 5.59 (142) Overall OD: 3.25 (83) End 1 ID: 1.87 (48)	ST1538IC	restriction indicator This product is not available in all regions of the world.
ST1517	MAHLE PI2130SMX3 This product is not available in all regions of the world. Overall Height: 10.12 (257) Overall OD: 3.25 (83) End 1 ID: 1.87 (48)	ST1527	MAHLE PI4230SMXVST25 This product is not available in all regions of the world. Overall Height: 10.12 (257) Overall OD: 3.25 (83) End 1 ID: 1.87 (48)	ST1539IC	restriction indicator This product is not available in all regions of the world.
				ST1541	MAHLE 852690DRG25 This product is not available in all regions of the world. Overall Height: 18.86 (479) End 1 OD: 5.10 (130) End 2 OD: 5.08 (129) End 1 ID: 2.84 (72) End 2 ID: 2.70 (69)

E. PRODUCT GUIDE

ST1542	MAHLE 852690DRG40 This product is not available in all regions of the world. Overall Height: 18.86 (479) End 1 OD: 5.10 (130) End 2 OD: 5.08 (129) End 1 ID: 2.84 (72) End 2 ID: 2.70 (69)	ST1554IC	restriction indicator This product is not available in all regions of the world.	ST1567	MAHLE P18205DRG25 This product is not available in all regions of the world. Overall Height: 3.70 (94) Overall OD: 1.85 (47) End 1 ID: 1.00 (26)
ST1543	MAHLE 852690SMX10 This product is not available in all regions of the world. Overall Height: 18.86 (479) End 1 OD: 5.10 (130) End 2 OD: 5.08 (129) End 1 ID: 2.84 (72) End 2 ID: 2.70 (69)	ST1555	PARKER GO1954Q This product is not available in all regions of the world. Overall Height: 12.54 (319) Overall OD: 3.68 (94) End 1 ID: 1.88 (48)	ST1568	MAHLE P18208DRG25 This product is not available in all regions of the world. Overall Height: 6.77 (172) Overall OD: 1.85 (47) End 1 ID: 1.00 (26)
ST1544	MAHLE 852690SMX25 This product is not available in all regions of the world. Overall Height: 18.86 (479) End 1 OD: 5.10 (130) End 2 OD: 5.08 (129) End 1 ID: 2.84 (72) End 2 ID: 2.70 (69)	ST1556IC	restriction indicator This product is not available in all regions of the world.	ST1569	MAHLE P18211DRG25 This product is not available in all regions of the world. Overall Height: 9.80 (249) Overall OD: 1.85 (47) End 1 ID: 1.00 (26)
ST1545	MAHLE P15205SMXVST6 This product is not available in all regions of the world. Overall Height: 3.70 (94) Overall OD: 1.85 (47) End 1 ID: 1.00 (26)	ST1557IC	restriction indicator This product is not available in all regions of the world.	ST1570	MAHLE P18215DRG25 This product is not available in all regions of the world. Overall Height: 5.59 (142) Overall OD: 3.25 (83) End 1 ID: 1.87 (48)
ST1546	MAHLE P15208SMXVST6 This product is not available in all regions of the world. Overall Height: 6.77 (172) Overall OD: 1.85 (47) End 1 ID: 1.00 (26)	ST1558MR	pressure gauge This product is not available in all regions of the world.	ST1571	MAHLE P18230DRG25 This product is not available in all regions of the world. Overall Height: 10.12 (257) Overall OD: 3.25 (83) End 1 ID: 1.87 (48)
ST1547	MAHLE P15211SMXVST6 This product is not available in all regions of the world. Overall Height: 9.80 (249) Overall OD: 1.85 (47) End 1 ID: 1.00 (26)	ST1560	MAHLE P15245SMXVST6 This product is not available in all regions of the world. Overall Height: 14.69 (373) Overall OD: 3.25 (83) End 1 ID: 1.87 (48)	ST1572	MAHLE P18245DRG25 This product is not available in all regions of the world. Overall Height: 14.69 (373) Overall OD: 3.25 (83) End 1 ID: 1.87 (48)
ST1548	MAHLE P15215SMXVST6 This product is not available in all regions of the world. Overall Height: 5.59 (142) Overall OD: 3.25 (83) End 1 ID: 1.87 (48)	ST1561	MAHLE P18105DRG10 This product is not available in all regions of the world. Overall Height: 3.70 (94) Overall OD: 1.85 (47) End 1 ID: 1.00 (26)	ST1573	MAHLE P18305DRG40 This product is not available in all regions of the world. Overall Height: 3.70 (94) Overall OD: 1.85 (47) End 1 ID: 1.00 (26)
ST1549	MAHLE P15230SMXVST6 This product is not available in all regions of the world. Overall Height: 10.12 (257) Overall OD: 3.25 (83) End 1 ID: 1.87 (48)	ST1562	MAHLE P18108DRG10 This product is not available in all regions of the world. Overall Height: 6.77 (172) Overall OD: 1.85 (47) End 1 ID: 1.00 (26)	ST1574	MAHLE P18308DRG40 This product is not available in all regions of the world. Overall Height: 6.77 (172) Overall OD: 1.85 (47) End 1 ID: 1.00 (26)
ST1551IC	restriction indicator This product is not available in all regions of the world.	ST1563	MAHLE P18111DRG10 This product is not available in all regions of the world. Overall Height: 9.80 (249) Overall OD: 1.85 (47) End 1 ID: 1.00 (26)	ST1575	MAHLE P18311DRG40 This product is not available in all regions of the world. Overall Height: 9.80 (249) Overall OD: 1.85 (47) End 1 ID: 1.00 (26)
ST1552IC	restriction indicator This product is not available in all regions of the world.	ST1564	MAHLE P18115DRG10 This product is not available in all regions of the world. Overall Height: 5.59 (142) Overall OD: 3.25 (83) End 1 ID: 1.87 (48)	ST1576	MAHLE P18315DRG40 This product is not available in all regions of the world. Overall Height: 5.59 (142) Overall OD: 3.25 (83) End 1 ID: 1.87 (48)
ST1553IC	restriction indicator This product is not available in all regions of the world.	ST1565	MAHLE P18130DRG10 This product is not available in all regions of the world. Overall Height: 10.12 (257) Overall OD: 3.25 (83) End 1 ID: 1.87 (48)		
		ST1566	MAHLE P18145DRG10 This product is not available in all regions of the world. Overall Height: 14.69 (373) Overall OD: 3.25 (83) End 1 ID: 1.87 (48)		

E. PRODUCT GUIDE

<p>ST1577 MAHLE PI8345DRG40 This product is not available in all regions of the world.</p> <p>Overall Height: 14.69 (373) Overall OD: 3.25 (83) End 1 ID: 1.87 (48)</p>	<p>ST1587 MAHLE PI8530DRG100 This product is not available in all regions of the world.</p> <p>Overall Height: 10.12 (257) Overall OD: 3.25 (83) End 1 ID: 1.87 (48)</p>	<p>ST1597 MAHLE PI9211DRGVST25 This product is not available in all regions of the world.</p> <p>Overall Height: 9.80 (249) Overall OD: 1.85 (47) End 1 ID: 1.00 (26)</p>
<p>ST1578 MAHLE PI8405DRG60 This product is not available in all regions of the world.</p> <p>Overall Height: 3.70 (94) Overall OD: 1.85 (47) End 1 ID: 1.00 (26)</p>	<p>ST1588 MAHLE PI8545DRG100 This product is not available in all regions of the world.</p> <p>Overall Height: 14.69 (373) Overall OD: 3.25 (83) End 1 ID: 1.87 (48)</p>	<p>ST1598 MAHLE PI9215DRGVST25 This product is not available in all regions of the world.</p> <p>Overall Height: 5.59 (142) End 1 OD: 3.25 (83) End 2 OD: 3.27 (83) End 1 ID: 1.87 (48)</p>
<p>ST1579 MAHLE PI8408DRG60 This product is not available in all regions of the world.</p> <p>Overall Height: 6.77 (172) Overall OD: 1.85 (47) End 1 ID: 1.00 (26)</p>	<p>ST1589 MAHLE PI9105DRGVST10 This product is not available in all regions of the world.</p> <p>Overall Height: 3.70 (94) Overall OD: 1.85 (47) End 1 ID: 1.00 (26)</p>	<p>ST1599 MAHLE PI9230DRGVST25 This product is not available in all regions of the world.</p> <p>Overall Height: 10.12 (257) End 1 OD: 3.25 (83) End 2 OD: 3.27 (83) End 1 ID: 1.87 (48)</p>
<p>ST1580 MAHLE PI8411DRG60 This product is not available in all regions of the world.</p> <p>Overall Height: 9.80 (249) Overall OD: 1.85 (47) End 1 ID: 1.00 (26)</p>	<p>ST1590 MAHLE PI9108DRGVST10 This product is not available in all regions of the world.</p> <p>Overall Height: 6.77 (172) Overall OD: 1.85 (47) End 1 ID: 1.00 (26)</p>	<p>ST1600 MAHLE PI9245DRGVST25 This product is not available in all regions of the world.</p> <p>Overall Height: 14.69 (373) End 1 OD: 3.25 (83) End 2 OD: 3.27 (83) End 1 ID: 1.87 (48)</p>
<p>ST1581 MAHLE PI8415DRG60 This product is not available in all regions of the world.</p> <p>Overall Height: 5.59 (142) Overall OD: 3.25 (83) End 1 ID: 1.87 (48)</p>	<p>ST1591 MAHLE PI9111DRGVST10 This product is not available in all regions of the world.</p> <p>Overall Height: 9.80 (249) Overall OD: 1.85 (47) End 1 ID: 1.00 (26)</p>	<p>ST1601 MAHLE PI9305DRGVST40 This product is not available in all regions of the world.</p> <p>Overall Height: 3.70 (94) Overall OD: 1.85 (47) End 1 ID: 1.00 (26)</p>
<p>ST1582 MAHLE PI8430DRG60 This product is not available in all regions of the world.</p> <p>Overall Height: 10.12 (257) Overall OD: 3.25 (83) End 1 ID: 1.87 (48)</p>	<p>ST1592 MAHLE PI9115DRGVST10 This product is not available in all regions of the world.</p> <p>Overall Height: 5.59 (142) End 1 OD: 3.25 (83) End 2 OD: 3.27 (83) End 1 ID: 1.87 (48)</p>	<p>ST1602 MAHLE PI9308DRGVST40 This product is not available in all regions of the world.</p> <p>Overall Height: 6.77 (172) Overall OD: 1.85 (47) End 1 ID: 1.00 (26)</p>
<p>ST1583 MAHLE PI8445DRG60 This product is not available in all regions of the world.</p> <p>Overall Height: 14.69 (373) Overall OD: 3.25 (83) End 1 ID: 1.87 (48)</p>	<p>ST1593 MAHLE PI9130DRGVST10 This product is not available in all regions of the world.</p> <p>Overall Height: 10.12 (257) End 1 OD: 3.25 (83) End 2 OD: 3.27 (83) End 1 ID: 1.87 (48)</p>	<p>ST1603 MAHLE PI9311DRGVST40 This product is not available in all regions of the world.</p> <p>Overall Height: 9.80 (249) Overall OD: 1.85 (47) End 1 ID: 1.00 (26)</p>
<p>ST1584 MAHLE PI8505DRG100 This product is not available in all regions of the world.</p> <p>Overall Height: 3.70 (94) Overall OD: 1.85 (47) End 1 ID: 1.00 (26)</p>	<p>ST1594 MAHLE PI9145DRGVST10 This product is not available in all regions of the world.</p> <p>Overall Height: 14.69 (373) End 1 OD: 3.25 (83) End 2 OD: 3.27 (83) End 1 ID: 1.87 (48)</p>	<p>ST1604 MAHLE PI9315DRGVST40 This product is not available in all regions of the world.</p> <p>Overall Height: 5.59 (142) End 1 OD: 3.25 (83) End 2 OD: 3.27 (83) End 1 ID: 1.87 (48)</p>
<p>ST1585 MAHLE PI8511DRG100 This product is not available in all regions of the world.</p> <p>Overall Height: 9.80 (249) Overall OD: 1.85 (47) End 1 ID: 1.00 (26)</p>	<p>ST1595 MAHLE PI9205DRGVST25 This product is not available in all regions of the world.</p> <p>Overall Height: 3.70 (94) Overall OD: 1.85 (47) End 1 ID: 1.00 (26)</p>	<p>ST1605 MAHLE PI9330DRGVST40 This product is not available in all regions of the world.</p> <p>Overall Height: 10.12 (257) End 1 OD: 3.25 (83) End 2 OD: 3.27 (83) End 1 ID: 1.87 (48)</p>
<p>ST1586 MAHLE PI8515DRG100 This product is not available in all regions of the world.</p> <p>Overall Height: 5.59 (142) Overall OD: 3.25 (83) End 1 ID: 1.87 (48)</p>	<p>ST1596 MAHLE PI9208DRGVST25 This product is not available in all regions of the world.</p> <p>Overall Height: 6.77 (172) Overall OD: 1.85 (47) End 1 ID: 1.00 (26)</p>	<p>ST1606 MAHLE PI9345DRGVST40 This product is not available in all regions of the world.</p> <p>Overall Height: 14.69 (373) End 1 OD: 3.25 (83) End 2 OD: 3.27 (83) End 1 ID: 1.87 (48)</p>

E. PRODUCT GUIDE

ST1607	MAHLE PI9405DRGVST60 This product is not available in all regions of the world. Overall Height: 3.70 (94) Overall OD: 1.85 (47) End 1 ID: 1.00 (26)	ST1617	MAHLE PI9545DRGVST100 This product is not available in all regions of the world. Overall Height: 14.69 (373) End 1 OD: 3.25 (83) End 2 OD: 3.27 (83) End 1 ID: 1.87 (48)	ST1627	MAHLE 852034SMX25 This product is not available in all regions of the world. Overall Height: 5.67 (144) Overall OD: 3.05 (78) End 1 ID: 1.08 (28)
ST1608	MAHLE PI9411DRGVST60 This product is not available in all regions of the world. Overall Height: 9.80 (249) Overall OD: 1.85 (47) End 1 ID: 1.00 (26)	ST1618	MAHLE 852034DRG10 This product is not available in all regions of the world. Overall Height: 5.67 (144) Overall OD: 3.05 (78) End 1 ID: 1.08 (28)	ST1628	MAHLE 852034SMXVST3 This product is not available in all regions of the world. Overall Height: 5.67 (144) Overall OD: 3.05 (78) End 1 ID: 1.08 (28)
ST1609	MAHLE PI9415DRGVST60 This product is not available in all regions of the world. Overall Height: 5.59 (142) End 1 OD: 3.25 (83) End 2 OD: 3.27 (83) End 1 ID: 1.87 (48)	ST1619	MAHLE 852034DRG25 This product is not available in all regions of the world. Overall Height: 5.67 (144) Overall OD: 3.05 (78) End 1 ID: 1.08 (28)	ST1629	MAHLE 852034SMXVST10 This product is not available in all regions of the world. Overall Height: 5.67 (144) Overall OD: 3.05 (78) End 1 ID: 1.08 (28)
ST1610	MAHLE PI9430DRGVST60 This product is not available in all regions of the world. Overall Height: 10.12 (257) End 1 OD: 3.25 (83) End 2 OD: 3.27 (83) End 1 ID: 1.87 (48)	ST1620	MAHLE 852034DRG100 This product is not available in all regions of the world. Overall Height: 5.67 (144) Overall OD: 3.05 (78) End 1 ID: 1.08 (28)	ST1630	MAHLE 852034SMXVST25 This product is not available in all regions of the world. Overall Height: 5.67 (144) Overall OD: 3.05 (78) End 1 ID: 1.08 (28)
ST1611	MAHLE PI9445DRGVST60 This product is not available in all regions of the world. Overall Height: 14.69 (373) End 1 OD: 3.25 (83) End 2 OD: 3.27 (83) End 1 ID: 1.87 (48)	ST1621	MAHLE 852034DRGVST10 This product is not available in all regions of the world. Overall Height: 5.67 (144) Overall OD: 3.05 (78) End 1 ID: 1.08 (28)	ST1631	MAHLE 852059DRG10 This product is not available in all regions of the world. Overall Height: 6.02 (153) Overall OD: 4.55 (116) End 1 ID: 2.56 (65) End 2 ID: 2.56 (65)
ST1612	MAHLE PI9505DRGVST100 This product is not available in all regions of the world. Overall Height: 3.70 (94) Overall OD: 1.85 (47) End 1 ID: 1.00 (26)	ST1622	MAHLE 852034DRGVST25 This product is not available in all regions of the world. Overall Height: 5.67 (144) Overall OD: 3.05 (78) End 1 ID: 1.08 (28)	ST1632	MAHLE 852059DRG25 This product is not available in all regions of the world. Overall Height: 6.02 (153) Overall OD: 4.55 (116) End 1 ID: 2.56 (65) End 2 ID: 2.56 (65)
ST1613	MAHLE PI9508DRGVST100 This product is not available in all regions of the world. Overall Height: 6.77 (172) Overall OD: 1.85 (47) End 1 ID: 1.00 (26)	ST1623	MAHLE 852034DRGVST60 This product is not available in all regions of the world. Overall Height: 5.67 (144) Overall OD: 3.05 (78) End 1 ID: 1.08 (28)	ST1633	MAHLE 852059DRG60 This product is not available in all regions of the world. Overall Height: 6.02 (153) Overall OD: 4.55 (116) End 1 ID: 2.56 (65) End 2 ID: 2.56 (65)
ST1614	MAHLE PI9511DRGVST100 This product is not available in all regions of the world. Overall Height: 9.80 (249) Overall OD: 1.85 (47) End 1 ID: 1.00 (26)	ST1624	MAHLE 852034DRGVST100 This product is not available in all regions of the world. Overall Height: 5.67 (144) Overall OD: 3.05 (78) End 1 ID: 1.08 (28)	ST1634	MAHLE 852059DRG100 This product is not available in all regions of the world. Overall Height: 6.02 (153) Overall OD: 4.55 (116) End 1 ID: 2.56 (65) End 2 ID: 2.56 (65)
ST1615	MAHLE PI9515DRGVST100 This product is not available in all regions of the world. Overall Height: 5.59 (142) End 1 OD: 3.25 (83) End 2 OD: 3.27 (83) End 1 ID: 1.87 (48)	ST1625	MAHLE 852034SMX3 This product is not available in all regions of the world. Overall Height: 5.67 (144) Overall OD: 3.05 (78) End 1 ID: 1.08 (28)	ST1635	MAHLE 852059SMX10 This product is not available in all regions of the world. Overall Height: 6.02 (153) Overall OD: 4.55 (116) End 1 ID: 2.56 (65) End 2 ID: 2.56 (65)
ST1616	MAHLE PI9530DRGVST100 This product is not available in all regions of the world. Overall Height: 10.12 (257) End 1 OD: 3.25 (83) End 2 OD: 3.27 (83) End 1 ID: 1.87 (48)	ST1626	MAHLE 852034SMX10 This product is not available in all regions of the world. Overall Height: 5.67 (144) Overall OD: 3.05 (78) End 1 ID: 1.08 (28)	ST1636	MAHLE 852059SMX25 This product is not available in all regions of the world. Overall Height: 6.02 (153) Overall OD: 4.55 (116) End 1 ID: 2.56 (65)

E. PRODUCT GUIDE

ST1637 MAHLE 852070DRG10 This product is not available in all regions of the world. Overall Height: 8.05 (205) Overall OD: 5.91 (150) End 1 ID: 3.50 (89)	ST1647 MAHLE 852087DRG100 This product is not available in all regions of the world. Overall Height: 7.56 (192) Overall OD: 6.30 (160) End 1 ID: 4.33 (110)	ST1657 MAHLE 852125DRGVST100 This product is not available in all regions of the world. Overall Height: 3.41 (87) Overall OD: 1.63 (42) End 1 ID: 0.89 (23)
ST1638 MAHLE 852070DRG25 This product is not available in all regions of the world. Overall Height: 8.05 (205) Overall OD: 5.91 (150) End 1 ID: 3.50 (89)	ST1648 MAHLE 852087SMX10 This product is not available in all regions of the world. Overall Height: 7.56 (192) Overall OD: 6.30 (160) End 1 ID: 4.33 (110)	ST1658 MAHLE 852125SMX3 This product is not available in all regions of the world. Overall Height: 3.37 (86) Overall OD: 1.63 (42) End 1 ID: 0.89 (23)
ST1639 MAHLE 852070DRG60 This product is not available in all regions of the world. Overall Height: 8.05 (205) Overall OD: 5.91 (150) End 1 ID: 3.50 (89)	ST1649 MAHLE 852125DRG10 This product is not available in all regions of the world. Overall Height: 3.37 (86) Overall OD: 1.63 (42) End 1 ID: 0.84 (21)	ST1659 MAHLE 852125SMX10 This product is not available in all regions of the world. Overall Height: 3.37 (86) Overall OD: 1.63 (42) End 1 ID: 0.89 (23)
ST1640 MAHLE 852070DRG100 This product is not available in all regions of the world. Overall Height: 8.05 (205) Overall OD: 5.91 (150) End 1 ID: 3.50 (89)	ST1650 MAHLE 852125DRG40 This product is not available in all regions of the world. Overall Height: 3.37 (86) Overall OD: 1.63 (42) End 1 ID: 0.84 (21)	ST1660 MAHLE 852125SMX25 This product is not available in all regions of the world. Overall Height: 3.37 (86) Overall OD: 1.63 (42) End 1 ID: 0.89 (23)
ST1641 MAHLE 852070SMX3 This product is not available in all regions of the world. Overall Height: 8.05 (205) Overall OD: 5.91 (150) End 1 ID: 3.50 (89)	ST1651 MAHLE 852125DRG60 This product is not available in all regions of the world. Overall Height: 3.37 (86) Overall OD: 1.63 (42) End 1 ID: 0.84 (21)	ST1661 MAHLE 852125SMXVST3 This product is not available in all regions of the world. Overall Height: 3.41 (87) Overall OD: 1.63 (42) End 1 ID: 0.89 (23)
ST1642 MAHLE 852070SMX10 This product is not available in all regions of the world. Overall Height: 8.05 (205) Overall OD: 5.91 (150) End 1 ID: 3.50 (89)	ST1652 MAHLE 852125DRG100 This product is not available in all regions of the world. Overall Height: 3.37 (86) Overall OD: 1.63 (42) End 1 ID: 0.84 (21)	ST1662 MAHLE 852125SMXVST10 This product is not available in all regions of the world. Overall Height: 3.41 (87) Overall OD: 1.63 (42) End 1 ID: 0.89 (23)
ST1643 MAHLE 852070SMX25 This product is not available in all regions of the world. Overall Height: 8.05 (205) Overall OD: 5.91 (150) End 1 ID: 3.50 (89)	ST1653 MAHLE 852125DRGVST10 This product is not available in all regions of the world. Overall Height: 3.41 (87) Overall OD: 1.63 (42) End 1 ID: 0.89 (23)	ST1663 MAHLE 852126DRG10 This product is not available in all regions of the world. Overall Height: 4.43 (113) Overall OD: 1.79 (46) End 1 ID: 0.95 (24)
ST1644 MAHLE 852087DRG10 This product is not available in all regions of the world. Overall Height: 7.56 (192) Overall OD: 6.30 (160) End 1 ID: 4.33 (110)	ST1654 MAHLE 852125DRGVST25 This product is not available in all regions of the world. Overall Height: 3.41 (87) Overall OD: 1.63 (42) End 1 ID: 0.89 (23)	ST1664 MAHLE 852126DRG25 This product is not available in all regions of the world. Overall Height: 4.43 (113) Overall OD: 1.79 (46) End 1 ID: 0.95 (24)
ST1645 MAHLE 852087DRG25 This product is not available in all regions of the world. Overall Height: 7.56 (192) Overall OD: 6.30 (160) End 1 ID: 4.33 (110)	ST1655 MAHLE 852125DRGVST40 This product is not available in all regions of the world. Overall Height: 3.41 (87) Overall OD: 1.63 (42) End 1 ID: 0.89 (23)	ST1665 MAHLE 852126DRG40 This product is not available in all regions of the world. Overall Height: 4.43 (113) Overall OD: 1.79 (46) End 1 ID: 0.95 (24)
ST1646 MAHLE 852087DRG60 This product is not available in all regions of the world. Overall Height: 7.56 (192) Overall OD: 6.30 (160) End 1 ID: 4.33 (110)	ST1656 MAHLE 852125DRGVST60 This product is not available in all regions of the world. Overall Height: 3.41 (87) Overall OD: 1.63 (42) End 1 ID: 0.89 (23)	ST1666 MAHLE 852126DRG100 This product is not available in all regions of the world. Overall Height: 4.43 (113) Overall OD: 1.79 (46) End 1 ID: 0.95 (24)

E. PRODUCT GUIDE

ST1667	MAHLE 852126DRGVST10 This product is not available in all regions of the world. Overall Height: 4.43 (113) Overall OD: 1.77 (45) End 1 ID: 1.00 (25)	ST1677	MAHLE 852127DRG10 This product is not available in all regions of the world. Overall Height: 6.95 (177) Overall OD: 2.03 (52) End 1 ID: 1.22 (31)	ST1687	MAHLE 852127SMX3 This product is not available in all regions of the world. Overall Height: 6.95 (177) Overall OD: 2.03 (52) End 1 ID: 1.22 (31)
ST1668	MAHLE 852126DRGVST25 This product is not available in all regions of the world. Overall Height: 4.43 (113) Overall OD: 1.77 (45) End 1 ID: 1.00 (25)	ST1678	MAHLE 852127DRG25 This product is not available in all regions of the world. Overall Height: 6.95 (177) Overall OD: 2.03 (52) End 1 ID: 1.22 (31)	ST1689	MAHLE 852127SMXVST3 This product is not available in all regions of the world. Overall Height: 6.95 (177) Overall OD: 2.03 (52) End 1 ID: 1.29 (33)
ST1669	MAHLE 852126DRGVST40 This product is not available in all regions of the world. Overall Height: 4.43 (113) Overall OD: 1.77 (45) End 1 ID: 1.00 (25)	ST1679	MAHLE 852127DRG40 This product is not available in all regions of the world. Overall Height: 6.95 (177) Overall OD: 2.03 (52) End 1 ID: 1.22 (31)	ST1690	MAHLE 852127SMXVST10 This product is not available in all regions of the world. Overall Height: 6.95 (177) Overall OD: 2.03 (52) End 1 ID: 1.29 (33)
ST1670	MAHLE 852126DRGVST100 This product is not available in all regions of the world. Overall Height: 4.43 (113) Overall OD: 1.77 (45) End 1 ID: 1.00 (25)	ST1680	MAHLE 852127DRG60 This product is not available in all regions of the world. Overall Height: 6.95 (177) Overall OD: 2.03 (52) End 1 ID: 1.22 (31)	ST1691	MAHLE 852127SMXVST25 This product is not available in all regions of the world. Overall Height: 6.95 (177) Overall OD: 2.03 (52) End 1 ID: 1.29 (33)
ST1671	MAHLE 852126SMX3 This product is not available in all regions of the world. Overall Height: 4.43 (113) End 1 OD: 1.79 (46) End 2 OD: 1.77 (45) End 1 ID: 1.01 (26)	ST1681	MAHLE 852127DRG100 This product is not available in all regions of the world. Overall Height: 6.95 (177) Overall OD: 2.03 (52) End 1 ID: 1.22 (31)	ST1692	MAHLE 852146DRG10 This product is not available in all regions of the world. Overall Height: 7.56 (192) Overall OD: 7.93 (202) End 1 ID: 5.51 (140)
ST1672	MAHLE 852126SMX10 This product is not available in all regions of the world. Overall Height: 4.43 (113) End 1 OD: 1.79 (46) End 2 OD: 1.77 (45) End 1 ID: 1.01 (26)	ST1682	MAHLE 852127DRGVST10 This product is not available in all regions of the world. Overall Height: 6.95 (177) Overall OD: 2.03 (52) End 1 ID: 1.29 (33)	ST1693	MAHLE 852146DRG25 This product is not available in all regions of the world. Overall Height: 7.56 (192) Overall OD: 7.93 (202) End 1 ID: 5.51 (140)
ST1673	MAHLE 852126SMXVST3 This product is not available in all regions of the world. Overall Height: 4.43 (113) Overall OD: 1.77 (45) End 1 ID: 1.01 (26)	ST1683	MAHLE 852127DRGVST25 This product is not available in all regions of the world. Overall Height: 6.95 (177) Overall OD: 2.03 (52) End 1 ID: 1.29 (33)	ST1694	MAHLE 852146DRG60 This product is not available in all regions of the world. Overall Height: 7.56 (192) Overall OD: 7.93 (202) End 1 ID: 5.51 (140)
ST1674	MAHLE 852126SMXVST6 This product is not available in all regions of the world. Overall Height: 4.43 (113) Overall OD: 1.77 (45) End 1 ID: 1.01 (26)	ST1684	MAHLE 852127DRGVST40 This product is not available in all regions of the world. Overall Height: 6.95 (177) Overall OD: 2.03 (52) End 1 ID: 1.29 (33)	ST1695	MAHLE 852146DRG100 This product is not available in all regions of the world. Overall Height: 7.56 (192) Overall OD: 7.93 (202) End 1 ID: 5.51 (140)
ST1675	MAHLE 852126SMXVST10 This product is not available in all regions of the world. Overall Height: 4.43 (113) Overall OD: 1.77 (45) End 1 ID: 1.01 (26)	ST1685	MAHLE 852127DRGVST60 This product is not available in all regions of the world. Overall Height: 6.95 (177) Overall OD: 2.03 (52) End 1 ID: 1.29 (33)	ST1696	MAHLE 852146SMX10 This product is not available in all regions of the world. Overall Height: 7.56 (192) Overall OD: 7.93 (202) End 1 ID: 5.51 (140)
ST1676	MAHLE 852126SMXVST25 This product is not available in all regions of the world. Overall Height: 4.43 (113) Overall OD: 1.77 (45) End 1 ID: 1.01 (26)	ST1686	MAHLE 852127DRGVST100 This product is not available in all regions of the world. Overall Height: 6.95 (177) Overall OD: 2.03 (52) End 1 ID: 1.29 (33)	ST1697	MAHLE 852146SMX25 This product is not available in all regions of the world. Overall Height: 7.56 (192) Overall OD: 7.93 (202) End 1 ID: 5.51 (140)

E. PRODUCT GUIDE

<p>ST1698 MAHLE 852264DRG10 This product is not available in all regions of the world.</p> <p>Overall Height: 7.64 (194) Overall OD: 5.04 (128) End 1 ID: 3.60 (91)</p>	<p>ST1708 MAHLE 852362DRGVST10 This product is not available in all regions of the world.</p> <p>Overall Height: 5.08 (129) Overall OD: 3.23 (82) End 1 ID: 1.33 (34)</p>	<p>ST1718 MAHLE 852435DRG25 This product is not available in all regions of the world.</p> <p>Overall Height: 8.72 (222) Overall OD: 5.08 (129) End 1 ID: 2.63 (67) End 2 ID: 2.78 (71)</p>
<p>ST1699 MAHLE 852264DRG25 This product is not available in all regions of the world.</p> <p>Overall Height: 7.64 (194) Overall OD: 5.04 (128) End 1 ID: 3.60 (91)</p>	<p>ST1709 MAHLE 852362DRGVST25 This product is not available in all regions of the world.</p> <p>Overall Height: 5.08 (129) Overall OD: 3.23 (82) End 1 ID: 1.33 (34)</p>	<p>ST1719 MAHLE 852435DRG40 This product is not available in all regions of the world.</p> <p>Overall Height: 8.72 (222) Overall OD: 5.08 (129) End 1 ID: 2.63 (67) End 2 ID: 2.78 (71)</p>
<p>ST1700 MAHLE 852264DRG60 This product is not available in all regions of the world.</p> <p>Overall Height: 7.64 (194) Overall OD: 5.04 (128) End 1 ID: 3.60 (91)</p>	<p>ST1710 MAHLE 852362DRGVST60 This product is not available in all regions of the world.</p> <p>Overall Height: 5.08 (129) Overall OD: 3.23 (82) End 1 ID: 1.33 (34)</p>	<p>ST1720 MAHLE 852435SMX10 This product is not available in all regions of the world.</p> <p>Overall Height: 8.72 (222) Overall OD: 5.08 (129) End 1 ID: 2.63 (67) End 2 ID: 2.78 (71)</p>
<p>ST1701 MAHLE 852264DRG100 This product is not available in all regions of the world.</p> <p>Overall Height: 7.64 (194) Overall OD: 5.04 (128) End 1 ID: 3.60 (91)</p>	<p>ST1711 MAHLE 852362DRGVST100 This product is not available in all regions of the world.</p> <p>Overall Height: 5.08 (129) Overall OD: 3.23 (82) End 1 ID: 1.33 (34)</p>	<p>ST1721 MAHLE 852435SMX25 This product is not available in all regions of the world.</p> <p>Overall Height: 8.72 (222) Overall OD: 5.08 (129) End 1 ID: 2.63 (67) End 2 ID: 2.78 (71)</p>
<p>ST1702 MAHLE 852264SMX10 This product is not available in all regions of the world.</p> <p>Overall Height: 7.64 (194) Overall OD: 5.04 (128) End 1 ID: 3.60 (91)</p>	<p>ST1712 MAHLE 852362SMX3 This product is not available in all regions of the world.</p> <p>Overall Height: 5.08 (129) Overall OD: 3.23 (82) End 1 ID: 1.33 (34)</p>	<p>ST1722 MAHLE 852436DRG25 This product is not available in all regions of the world.</p> <p>Overall Height: 12.60 (320) Overall OD: 5.08 (129) End 1 ID: 2.63 (67) End 2 ID: 2.78 (71)</p>
<p>ST1703 MAHLE 852264SMX25 This product is not available in all regions of the world.</p> <p>Overall Height: 7.64 (194) Overall OD: 5.04 (128) End 1 ID: 3.60 (91)</p>	<p>ST1713 MAHLE 852362SMX10 This product is not available in all regions of the world.</p> <p>Overall Height: 5.08 (129) Overall OD: 3.23 (82) End 1 ID: 1.33 (34)</p>	<p>ST1723 MAHLE 852436DRG40 This product is not available in all regions of the world.</p> <p>Overall Height: 12.60 (320) Overall OD: 5.08 (129) End 1 ID: 2.63 (67) End 2 ID: 2.78 (71)</p>
<p>ST1704 MAHLE 852362DRG10 This product is not available in all regions of the world.</p> <p>Overall Height: 5.08 (129) Overall OD: 3.23 (82) End 1 ID: 1.30 (33)</p>	<p>ST1714 MAHLE 852362SMX25 This product is not available in all regions of the world.</p> <p>Overall Height: 5.08 (129) Overall OD: 3.23 (82) End 1 ID: 1.33 (34)</p>	<p>ST1724 MAHLE 852436SMX25 This product is not available in all regions of the world.</p> <p>Overall Height: 12.60 (320) Overall OD: 5.08 (129) End 1 ID: 2.63 (67) End 2 ID: 2.78 (71)</p>
<p>ST1705 MAHLE 852362DRG25 This product is not available in all regions of the world.</p> <p>Overall Height: 5.08 (129) Overall OD: 3.23 (82) End 1 ID: 1.30 (33)</p>	<p>ST1715 MAHLE 852362SMXVST3 This product is not available in all regions of the world.</p> <p>Overall Height: 5.08 (129) Overall OD: 3.23 (82) End 1 ID: 1.33 (34)</p>	<p>ST1725 MAHLE 852438DRG25 This product is not available in all regions of the world.</p> <p>Overall Height: 6.14 (156) Overall OD: 3.90 (99) End 1 ID: 1.91 (49) End 2 ID: 2.05 (52)</p>
<p>ST1706 MAHLE 852362DRG60 This product is not available in all regions of the world.</p> <p>Overall Height: 5.08 (129) Overall OD: 3.23 (82) End 1 ID: 1.30 (33)</p>	<p>ST1716 MAHLE 852362SMXVST10 This product is not available in all regions of the world.</p> <p>Overall Height: 5.08 (129) Overall OD: 3.23 (82) End 1 ID: 1.33 (34)</p>	<p>ST1726 MAHLE 852438DRG40 This product is not available in all regions of the world.</p> <p>Overall Height: 6.14 (156) Overall OD: 3.90 (99) End 1 ID: 1.91 (49) End 2 ID: 2.05 (52)</p>
<p>ST1707 MAHLE 852362DRG100 This product is not available in all regions of the world.</p> <p>Overall Height: 5.08 (129) Overall OD: 3.23 (82) End 1 ID: 1.30 (33)</p>	<p>ST1717 MAHLE 852362SMXVST25 This product is not available in all regions of the world.</p> <p>Overall Height: 5.08 (129) Overall OD: 3.23 (82) End 1 ID: 1.33 (34)</p>	

E. PRODUCT GUIDE

ST1727	MAHLE 852439DRG40 This product is not available in all regions of the world. Overall Height: 8.58 (218) Overall OD: 3.90 (99) End 1 ID: 1.91 (49) End 2 ID: 2.05 (52)	ST1736	MAHLE 852493DRG40 This product is not available in all regions of the world. Overall Height: 3.60 (92) Overall OD: 1.63 (42) End 1 ID: 0.84 (21)	ST1757	HIAB 9824499 This product is not available in all regions of the world. Overall Height: 5.91 (150) Overall OD: 2.84 (72) End 1 ID: 0.32 (8) End 2 ID: 1.75 (45)
ST1728	MAHLE 852439SMX25 This product is not available in all regions of the world. Overall Height: 8.58 (218) Overall OD: 3.90 (99) End 1 ID: 1.91 (49) End 2 ID: 2.09 (53)	ST1737	MAHLE 852493SMX10 This product is not available in all regions of the world. Overall Height: 3.60 (92) Overall OD: 1.63 (42) End 1 ID: 0.84 (21)	ST1758	EPPENSTEINER 232H10LL This product is not available in all regions of the world. Overall Height: 3.31 (84) Overall OD: 1.75 (45) End 1 ID: 0.61 (16)
ST1729	MAHLE 852443DRG25 This product is not available in all regions of the world. Overall Height: 4.11 (105) Overall OD: 2.28 (58) End 1 ID: 1.21 (31) End 2 ID: 0.83 (21)	ST1738	MAHLE 852493SMX25 This product is not available in all regions of the world. Overall Height: 3.60 (92) Overall OD: 1.63 (42) End 1 ID: 0.84 (21)	ST1759	EPPENSTEINER 2140H10LL This product is not available in all regions of the world. Overall Height: 5.95 (151) Overall OD: 2.91 (74) End 1 ID: 1.59 (41)
ST1730	MAHLE 852443DRG40 This product is not available in all regions of the world. Overall Height: 4.11 (105) Overall OD: 2.28 (58) End 1 ID: 1.21 (31) End 2 ID: 0.83 (21)	ST1739	MAHLE 852760SMX3 This product is not available in all regions of the world. Overall Height: 16.69 (424) Overall OD: 5.51 (140) End 1 ID: 2.56 (65)	ST1760	EPPENSTEINER 1225P10 This product is not available in all regions of the world. Overall Height: 8.74 (222) Overall OD: 2.89 (74) End 1 ID: 1.50 (38) End 2 ID: 1.81 (46)
ST1731	MAHLE 852443SMX25 This product is not available in all regions of the world. Overall Height: 4.11 (105) Overall OD: 2.28 (58) End 1 ID: 1.21 (31) End 2 ID: 0.83 (21)	ST1740	MAHLE 852760SMX25 This product is not available in all regions of the world. Overall Height: 16.69 (424) Overall OD: 5.51 (140) End 1 ID: 2.56 (65)	ST1761	FINN FC1260F025XS This product is not available in all regions of the world. Overall Height: 10.24 (260) Overall OD: 2.84 (72) End 1 ID: 0.32 (8) End 2 ID: 1.75 (45)
ST1732	MAHLE 852444DRG25 This product is not available in all regions of the world. Overall Height: 7.07 (180) Overall OD: 2.28 (58) End 1 ID: 1.21 (31) End 2 ID: 0.83 (21)	ST1741	MAHLE 852761SMX3 This product is not available in all regions of the world. Overall Height: 33.39 (848) Overall OD: 5.51 (140) End 1 ID: 2.56 (65)	ST1762	EPPENSTEINER 2225G402V This product is not available in all regions of the world. Overall Height: 8.90 (226) Overall OD: 2.91 (74) End 1 ID: 1.59 (41)
ST1733	MAHLE 852444DRG40 This product is not available in all regions of the world. Overall Height: 7.07 (180) Overall OD: 2.28 (58) End 1 ID: 1.21 (31) End 2 ID: 0.83 (21)	ST1742	MAHLE 852761SMX25 This product is not available in all regions of the world. Overall Height: 33.39 (848) Overall OD: 5.51 (140) End 1 ID: 2.56 (65)	ST1763	MAHLE 852126MIC10 This product is not available in all regions of the world. Overall Height: 4.45 (113) Overall OD: 1.77 (45) End 1 ID: 0.95 (24)
ST1734	MAHLE 852444SMX10 This product is not available in all regions of the world. Overall Height: 7.07 (180) Overall OD: 2.28 (58) End 1 ID: 1.21 (31) End 2 ID: 0.83 (21)	ST1749	LOGLIFT 38320034 This product is not available in all regions of the world. Overall Height: 10.24 (260) Overall OD: 4.17 (106) End 1 ID: 1.16 (30) End 2 ID: 2.84 (72)	ST1764	PARKER GO2075 This product is not available in all regions of the world. Overall Height: 9.57 (243) End 1 OD: 2.36 (60) End 2 OD: 2.44 (62) End 1 ID: 1.11 (28) End 2 ID: 0.95 (24)
ST1735	MAHLE 852493DRG25 This product is not available in all regions of the world. Overall Height: 3.60 (92) Overall OD: 1.63 (42) End 1 ID: 0.84 (21)	ST1750IC	restriction indicator This product is not available in all regions of the world.	ST1765	PARKER GO3774 This product is not available in all regions of the world. Overall Height: 9.67 (246) Overall OD: 2.64 (67) End 1 ID: 1.00 (26)
		ST1755	MP FILTRI HP3202M60AN This product is not available in all regions of the world. Overall Height: 9.29 (236) Overall OD: 3.07 (78) End 1 ID: 1.52 (39)	ST1766	EPPENSTEINER 1225H10LL This product is not available in all regions of the world. Overall Height: 8.86 (225) Overall OD: 2.91 (74) End 1 ID: 1.81 (46) End 2 ID: 1.51 (38)
		ST1756	MAHLE 852125MIC10 This product is not available in all regions of the world. Overall Height: 3.43 (87) Overall OD: 1.63 (42) End 1 ID: 0.84 (21)		

E. PRODUCT GUIDE

<p>ST1767 EPPENSTEINER 1225H20LL This product is not available in all regions of the world.</p> <p>Overall Height: 8.86 (225) Overall OD: 2.91 (74) End 1 ID: 1.81 (46) End 2 ID: 1.51 (38)</p>	<p>ST1780 EPPENSTEINER 256H20LL This product is not available in all regions of the world.</p> <p>Overall Height: 3.76 (96) Overall OD: 2.11 (54) End 1 ID: 0.92 (23)</p>	<p>ST1791 MP FILTRI CH050P10A This product is not available in all regions of the world.</p> <p>Overall Height: 5.79 (147) Largest OD: 3.80 (97) Thread Size: M32 X 1.5-6H INT</p>
<p>ST1769 EPPENSTEINER 2360H10LL This product is not available in all regions of the world.</p> <p>Overall Height: 10.91 (277) Overall OD: 2.91 (74) End 1 ID: 1.59 (41)</p>	<p>ST1781 EPPENSTEINER 290H10LL This product is not available in all regions of the world.</p> <p>Overall Height: 5.95 (151) Overall OD: 2.11 (54) End 1 ID: 0.92 (23)</p>	<p>ST1796 EPPENSTEINER 2225H10LL2 This product is not available in all regions of the world.</p> <p>Overall Height: 8.90 (226) Overall OD: 2.91 (74) End 1 ID: 1.56 (40)</p>
<p>ST1770 EPPENSTEINER 2360H20LL This product is not available in all regions of the world.</p> <p>Overall Height: 10.91 (277) Overall OD: 2.91 (74) End 1 ID: 1.59 (41)</p>	<p>ST1782 EPPENSTEINER 290H20LL This product is not available in all regions of the world.</p> <p>Overall Height: 5.95 (151) Overall OD: 2.11 (54) End 1 ID: 0.92 (23)</p>	<p>ST1797 EPPENSTEINER 2225H20LL2 This product is not available in all regions of the world.</p> <p>Overall Height: 8.90 (226) Overall OD: 2.91 (74) End 1 ID: 1.56 (40)</p>
<p>ST1771 EPPENSTEINER 2360H10LL2 This product is not available in all regions of the world.</p> <p>Overall Height: 10.89 (277) Overall OD: 2.91 (74) End 1 ID: 1.59 (41)</p>	<p>ST1783 EPPENSTEINER 290P10 This product is not available in all regions of the world.</p> <p>Overall Height: 5.95 (151) Overall OD: 2.11 (54) End 1 ID: 0.92 (23)</p>	<p>ST1798 INTERNORMEN 1E36025VG30EP This product is not available in all regions of the world.</p> <p>Overall Height: 12.13 (308) Overall OD: 2.36 (60) End 1 ID: 1.35 (34)</p>
<p>ST1772 EPPENSTEINER 2360H20LL2 This product is not available in all regions of the world.</p> <p>Overall Height: 10.89 (277) Overall OD: 2.91 (74) End 1 ID: 1.59 (41)</p>	<p>ST1784 EPPENSTEINER 2140G100 This product is not available in all regions of the world.</p> <p>Overall Height: 5.95 (151) Overall OD: 2.91 (74) End 1 ID: 1.56 (40)</p>	<p>ST1799 INTERNORMEN 1E45025VG30EP This product is not available in all regions of the world.</p> <p>Overall Height: 16.26 (413) Overall OD: 2.36 (60) End 1 ID: 1.35 (34)</p>
<p>ST1775 EPPENSTEINER 218G25 This product is not available in all regions of the world.</p> <p>Overall Height: 2.09 (53) Overall OD: 1.75 (45) End 1 ID: 0.61 (16)</p>	<p>ST1785 EPPENSTEINER 2140H6LL This product is not available in all regions of the world.</p> <p>Overall Height: 5.95 (151) Overall OD: 2.91 (74) End 1 ID: 1.56 (40)</p>	<p>ST1801 MAHLE PI21004RNSMX3 This product is not available in all regions of the world.</p> <p>Overall Height: 3.90 (99) Overall OD: 2.28 (58) End 1 ID: 1.27 (32)</p>
<p>ST1776 EPPENSTEINER 1140G25 This product is not available in all regions of the world.</p> <p>Overall Height: 5.83 (148) Overall OD: 2.91 (74) End 1 ID: 1.81 (46) End 2 ID: 1.51 (38)</p>	<p>ST1786 EPPENSTEINER 2140H20LL This product is not available in all regions of the world.</p> <p>Overall Height: 5.95 (151) Overall OD: 2.91 (74) End 1 ID: 1.56 (40)</p>	<p>ST1802 MAHLE PI22004RNSMX6 This product is not available in all regions of the world.</p> <p>Overall Height: 3.90 (99) Overall OD: 2.28 (58) End 1 ID: 1.27 (32)</p>
<p>ST1777 EPPENSTEINER 1225G25 This product is not available in all regions of the world.</p> <p>Overall Height: 8.86 (225) Overall OD: 2.91 (74) End 1 ID: 1.81 (46) End 2 ID: 1.51 (38)</p>	<p>ST1787 EPPENSTEINER 2225G100 This product is not available in all regions of the world.</p> <p>Overall Height: 8.90 (226) Overall OD: 2.91 (74) End 1 ID: 1.56 (40)</p>	<p>ST1803 MAHLE PI23004RNSMX10 This product is not available in all regions of the world.</p> <p>Overall Height: 3.90 (99) Overall OD: 2.28 (58) End 1 ID: 1.27 (32)</p>
<p>ST1778 EPPENSTEINER 256H6LL This product is not available in all regions of the world.</p> <p>Overall Height: 3.76 (96) Overall OD: 2.11 (54) End 1 ID: 0.92 (23)</p>	<p>ST1788 EPPENSTEINER 2225H10LL This product is not available in all regions of the world.</p> <p>Overall Height: 8.90 (226) Overall OD: 2.91 (74) End 1 ID: 1.59 (41)</p>	<p>ST1804 MAHLE PI25004RNSMX25 This product is not available in all regions of the world.</p> <p>Overall Height: 3.90 (99) Overall OD: 2.28 (58) End 1 ID: 1.27 (32)</p>
<p>ST1779 EPPENSTEINER 256H10LL This product is not available in all regions of the world.</p> <p>Overall Height: 3.76 (96) Overall OD: 2.11 (54) End 1 ID: 0.92 (23)</p>	<p>ST1789 EPPENSTEINER 2225H20LL This product is not available in all regions of the world.</p> <p>Overall Height: 8.90 (226) Overall OD: 2.91 (74) End 1 ID: 1.59 (41)</p>	<p>ST1811 PARKER GO1098Q This product is not available in all regions of the world.</p> <p>Overall Height: 12.54 (319) Overall OD: 3.68 (94) End 1 ID: 1.88 (48)</p>

E. PRODUCT GUIDE

ST1813	MP FILTRI CS050M90A This product is not available in all regions of the world. Overall Height: 5.91 (150) Largest OD: 3.78 (96) Thread Size: 3/4-14 BSP	ST1823	MP FILTRI HP3202A25AN This product is not available in all regions of the world. Overall Height: 9.23 (235) End 1 OD: 3.07 (78) End 2 OD: 3.11 (79) End 1 ID: 1.53 (39)	ST1851	INTERNORMEN 1E9025VGHREP This product is not available in all regions of the world. Overall Height: 6.89 (175) Overall OD: 1.75 (45) End 1 ID: 0.83 (21)
ST1814	MP FILTRI CS100M90A Filter used with ST1028HH This product is not available in all regions of the world. Overall Height: 7.11 (181) Largest OD: 5.04 (128) Thread Size: 1 1/4 BSP	ST1824	MP FILTRI HP3203A10AN This product is not available in all regions of the world. Overall Height: 14.74 (375) End 1 OD: 3.07 (78) End 2 OD: 3.11 (79) End 1 ID: 1.53 (39)	ST1852	INTERNORMEN 1E15025VGHREP This product is not available in all regions of the world. Overall Height: 11.22 (285) Overall OD: 1.75 (45) End 1 ID: 0.83 (21)
ST1815	MAHLE PI13010RNMIC10 This product is not available in all regions of the world. Overall Height: 9.80 (249) Overall OD: 2.28 (58) End 1 ID: 1.24 (32) End 2 ID: 1.24 (32)	ST1825	MP FILTRI CU250A25A This product is not available in all regions of the world. Overall Height: 8.37 (213) Overall OD: 3.90 (99) End 1 ID: 1.95 (49)	ST1853	INTERNORMEN 1E24025VGHREP This product is not available in all regions of the world. Overall Height: 9.02 (229) Overall OD: 2.36 (60) End 1 ID: 1.30 (33)
ST1816	PARKER 10119620C This product is not available in all regions of the world. Overall Height: 6.58 (167) Overall OD: 2.76 (70) End 1 ID: 1.69 (43)	ST1826	MP FILTRI CU630A25A This product is not available in all regions of the world. Overall Height: 9.92 (252) Overall OD: 5.12 (130) End 1 ID: 2.90 (74)	ST1854	INTERNORMEN 1E36025VGHREP This product is not available in all regions of the world. Overall Height: 12.13 (308) Overall OD: 2.36 (60) End 1 ID: 1.30 (33)
ST1817	This product is not available in all regions of the world. Overall Height: 9.57 (243) Overall OD: 2.36 (60) End 1 ID: 1.11 (28) End 2 ID: 0.95 (24)	ST1831	PARKER GO1286Q This product is not available in all regions of the world. Overall Height: 5.37 (137) Overall OD: 2.36 (60) End 1 ID: 1.00 (26)	ST1855	INTERNORMEN 1E45025VGHREP This product is not available in all regions of the world. Overall Height: 16.26 (413) Overall OD: 2.36 (60) End 1 ID: 1.30 (33)
ST1819	MP FILTRI HP3201A10AN This product is not available in all regions of the world. Overall Height: 4.51 (115) End 1 OD: 3.07 (78) End 2 OD: 3.11 (79) End 1 ID: 1.53 (39)	ST1832	PARKER GO3773 This product is not available in all regions of the world. Overall Height: 9.67 (246) Overall OD: 2.64 (67) End 1 ID: 1.00 (26)	ST1856	EPPENSTEINER 2900H20SLC000P This product is not available in all regions of the world. Overall Height: 12.84 (326) Overall OD: 4.02 (102) End 1 ID: 2.34 (60)
ST1820	MP FILTRI HP3201A25AN This product is not available in all regions of the world. Overall Height: 4.51 (115) End 1 OD: 3.07 (78) End 2 OD: 3.11 (79) End 1 ID: 1.53 (39)	ST1837	PARKER GO1938Q This product is not available in all regions of the world. Overall Height: 9.67 (246) Overall OD: 2.36 (60) End 1 ID: 1.00 (26)	ST1857	EPPENSTEINER 256G100A000P This product is not available in all regions of the world. Overall Height: 3.76 (96) Overall OD: 2.11 (54) End 1 ID: 0.92 (23)
ST1821	MP FILTRI HP3201M60AN This product is not available in all regions of the world. Overall Height: 4.51 (115) End 1 OD: 3.07 (78) End 2 OD: 3.11 (79) End 1 ID: 1.53 (39)	ST1848	INTERNORMEN 1E906VGHREP This product is not available in all regions of the world. Overall Height: 6.89 (175) Overall OD: 1.75 (45) End 1 ID: 0.83 (21)	ST1858	EPPENSTEINER 2560H10SLA000P This product is not available in all regions of the world. Overall Height: 9.02 (229) Overall OD: 4.02 (102) End 1 ID: 2.34 (60)
ST1822	MP FILTRI HP3202A10AN This product is not available in all regions of the world. Overall Height: 9.23 (235) End 1 OD: 3.07 (78) End 2 OD: 3.11 (79) End 1 ID: 1.53 (39)	ST1849	INTERNORMEN 1E3606VGHREP This product is not available in all regions of the world. Overall Height: 12.13 (308) Overall OD: 2.36 (60) End 1 ID: 1.30 (33)	ST1859	EPPENSTEINER 2560H20SLA000P This product is not available in all regions of the world. Overall Height: 9.02 (229) Overall OD: 4.02 (102) End 1 ID: 2.34 (60)
		ST1850	INTERNORMEN 1E6025VGHREP This product is not available in all regions of the world. Overall Height: 4.33 (110) Overall OD: 1.75 (45) End 1 ID: 0.83 (21)		

E. PRODUCT GUIDE

ST1860 EPPENSTEINER 2560H10SLC000P This product is not available in all regions of the world. Overall Height: 9.02 (229) Overall OD: 4.02 (102) End 1 ID: 2.34 (60)	ST1871 EPPENSTEINER 1361H6SLA000P This product is not available in all regions of the world. Overall Height: 9.09 (231) Overall OD: 4.02 (102) End 1 ID: 2.34 (60)	ST1882 HYVA 14896991A This product is not available in all regions of the world. Overall Height: 8.56 (218) Overall OD: 2.76 (70) BPV Setting: 29.01 (200) End 1 ID: 1.54 (39)
ST1861 EPPENSTEINER 2560H20SLC000P This product is not available in all regions of the world. Overall Height: 9.02 (229) Overall OD: 4.02 (102) End 1 ID: 2.34 (60)	ST1872 INTERNORMEN 1E6010VG30EP This product is not available in all regions of the world. Overall Height: 4.33 (110) Overall OD: 1.75 (45) End 1 ID: 0.83 (21)	ST1883HH This product is not available in all regions of the world.
ST1862 EPPENSTEINER 2900H10SLA000P This product is not available in all regions of the world. Overall Height: 12.84 (326) Overall OD: 4.02 (102) End 1 ID: 2.34 (60)	ST1873 INTERNORMEN 1E4506VGHREP This product is not available in all regions of the world. Overall Height: 16.26 (413) Overall OD: 2.36 (60) End 1 ID: 1.30 (33)	ST1888 INTERNORMEN 1E95010VG10SP This product is not available in all regions of the world. Overall Height: 13.78 (350) Overall OD: 5.59 (142) BPV Setting: 29.01 (200) End 1 ID: 3.35 (85)
ST1863 EPPENSTEINER 2900H20SLA000P This product is not available in all regions of the world. Overall Height: 12.84 (326) Overall OD: 4.02 (102) End 1 ID: 2.34 (60)	ST1874 EPPENSTEINER 156P25A000P This product is not available in all regions of the world. Overall Height: 3.64 (93) Overall OD: 2.11 (54) End 1 ID: 1.00 (26) End 2 ID: 1.30 (33)	ST1889 HYDAC 60D025WHC, HYDAC 313442 This product is not available in all regions of the world. Overall Height: 3.31 (84) Overall OD: 1.85 (47) End 1 ID: 0.83 (21)
ST1866 EPPENSTEINER 232G40A000P This product is not available in all regions of the world. Overall Height: 3.31 (84) Overall OD: 1.75 (45) End 1 ID: 0.61 (16)	ST1875 INTERNORMEN 1E42525VG16SP This product is not available in all regions of the world. Overall Height: 12.13 (308) Overall OD: 3.27 (83) BPV Setting: 29.01 (200) End 1 ID: 1.77 (45)	ST1890 HYDAC 60D050WHC This product is not available in all regions of the world. Overall Height: 3.31 (84) Overall OD: 1.85 (47) End 1 ID: 0.83 (21)
ST1867 EPPENSTEINER 11401G60A000P This product is not available in all regions of the world. Overall Height: 20.20 (513) Overall OD: 5.61 (143) End 1 ID: 3.62 (92) End 2 ID: 3.62 (92)	ST1876 MP FILTRI HP0651A10AN This product is not available in all regions of the world. Overall Height: 3.35 (85) Overall OD: 1.85 (47) End 1 ID: 0.98 (25)	ST1891 HYDAC 60D100WHC This product is not available in all regions of the world. Overall Height: 3.31 (84) Overall OD: 1.85 (47) End 1 ID: 0.83 (21)
ST1868 EPPENSTEINER 110G10A000P This product is not available in all regions of the world. Overall Height: 1.14 (29) Overall OD: 1.73 (44) End 1 ID: 1.02 (26) End 2 ID: 0.77 (20)	ST1878 EPPENSTEINER 290G60 This product is not available in all regions of the world. Overall Height: 5.95 (151) Overall OD: 2.11 (54) End 1 ID: 0.92 (23)	ST1892 HYDAC 110D025WHC This product is not available in all regions of the world. Overall Height: 6.02 (153) Overall OD: 1.85 (47) End 1 ID: 0.83 (21)
ST1869 EPPENSTEINER 1901P25A000P This product is not available in all regions of the world. Overall Height: 15.22 (387) Overall OD: 5.61 (143) End 1 ID: 3.62 (92) End 2 ID: 3.62 (92)	ST1879 EPPENSTEINER 1560G25 This product is not available in all regions of the world. Overall Height: 10.32 (262) Overall OD: 5.59 (142) End 1 ID: 3.70 (94) End 2 ID: 3.70 (94)	ST1893 HYDAC 110D050WHC This product is not available in all regions of the world. Overall Height: 6.02 (153) Overall OD: 1.85 (47) End 1 ID: 0.83 (21)
ST1870 EPPENSTEINER 11401G40A000P This product is not available in all regions of the world. Overall Height: 20.22 (514) Overall OD: 5.61 (143) End 1 ID: 3.62 (92)	ST1880 MAHLE 852885MIC25 This product is not available in all regions of the world. Overall Height: 6.32 (161) Overall OD: 2.76 (70) End 1 ID: 1.29 (33) End 2 ID: 1.29 (33)	ST1894 HYDAC 110D100WHC This product is not available in all regions of the world. Overall Height: 6.02 (153) Overall OD: 1.85 (47) End 1 ID: 0.83 (21)
		ST1895 HYDAC 140D025WHC This product is not available in all regions of the world. Overall Height: 7.60 (193) Overall OD: 1.85 (47) End 1 ID: 0.83 (21)

E. PRODUCT GUIDE

ST1896	HYDAC 140D050WHC This product is not available in all regions of the world. Overall Height: 7.60 (193) Overall OD: 1.85 (47) End 1 ID: 0.83 (21)	ST1906	HYDAC 280D100WHC This product is not available in all regions of the world. Overall Height: 14.02 (356) Overall OD: 2.72 (69) End 1 ID: 1.30 (33)	ST1916	EPENSTEINER 1561G100A000P This product is not available in all regions of the world. Overall Height: 10.37 (264) Overall OD: 5.61 (143) End 1 ID: 3.62 (92)
ST1897	HYDAC 140D100WHC This product is not available in all regions of the world. Overall Height: 7.60 (193) Overall OD: 1.85 (47) End 1 ID: 0.83 (21)	ST1907	HYDAC 330D025WHC This product is not available in all regions of the world. Overall Height: 6.46 (164) Overall OD: 3.56 (91) End 1 ID: 1.83 (47)	ST1917	MP FILTRI CS150A10A This product is not available in all regions of the world. Overall Height: 8.92 (227) Largest OD: 5.04 (128) Thread Size: 1 1/4 BSP
ST1898	HYDAC 160D025WHC This product is not available in all regions of the world. Overall Height: 4.57 (116) Overall OD: 2.72 (69) End 1 ID: 1.30 (33)	ST1908	HYDAC 330D050WHC This product is not available in all regions of the world. Overall Height: 6.46 (164) Overall OD: 3.56 (91) End 1 ID: 1.83 (47)	ST1918	MP FILTRI HP1352M60AN This product is not available in all regions of the world. Overall Height: 9.06 (230) Overall OD: 2.13 (54) End 1 ID: 1.02 (26)
ST1899	HYDAC 160D050WHC This product is not available in all regions of the world. Overall Height: 4.57 (116) Overall OD: 2.72 (69) End 1 ID: 1.30 (33)	ST1909	HYDAC 330D100WHC This product is not available in all regions of the world. Overall Height: 6.46 (164) Overall OD: 3.56 (91) End 1 ID: 1.83 (47)	ST1919	MAHLE PI22006RNSMX6 This product is not available in all regions of the world. Overall Height: 6.26 (159) Overall OD: 2.28 (58) End 1 ID: 1.27 (32)
ST1900	HYDAC 160D100WHC This product is not available in all regions of the world. Overall Height: 4.57 (116) Overall OD: 2.72 (69) End 1 ID: 1.30 (33)	ST1910	HYDAC 500D025WHC This product is not available in all regions of the world. Overall Height: 9.96 (253) Overall OD: 3.56 (91) End 1 ID: 1.83 (47)	ST1921	PARKER GO4252Q This product is not available in all regions of the world. Overall Height: 8.70 (221) Overall OD: 2.09 (53) End 1 ID: 0.79 (20)
ST1901	HYDAC 240D025WHC This product is not available in all regions of the world. Overall Height: 6.89 (175) Overall OD: 2.72 (69) End 1 ID: 1.30 (33)	ST1911	HYDAC 500D050WHC This product is not available in all regions of the world. Overall Height: 9.96 (253) Overall OD: 3.56 (91) End 1 ID: 1.83 (47)	ST1922	PARKER GO4268Q This product is not available in all regions of the world. Overall Height: 9.76 (248) Overall OD: 2.64 (67) End 1 ID: 1.00 (26)
ST1902	HYDAC 240D050WHC This product is not available in all regions of the world. Overall Height: 6.89 (175) Overall OD: 2.72 (69) End 1 ID: 1.30 (33)	ST1912	HYDAC 500D100WHC This product is not available in all regions of the world. Overall Height: 9.96 (253) Overall OD: 3.56 (91) End 1 ID: 1.83 (47)	ST1923	PARKER GO4284Q This product is not available in all regions of the world. Overall Height: 12.60 (320) Overall OD: 3.68 (94) End 1 ID: 1.77 (45)
ST1903	HYDAC 240D100WHC This product is not available in all regions of the world. Overall Height: 6.89 (175) Overall OD: 2.72 (69) End 1 ID: 1.30 (33)	ST1913	HYDAC 660D025WHC This product is not available in all regions of the world. Overall Height: 12.95 (329) Overall OD: 3.56 (91) End 1 ID: 1.83 (47)	ST1924	PARKER GO4352Q This product is not available in all regions of the world. Overall Height: 8.19 (208) Overall OD: 1.79 (46) End 1 ID: 0.95 (24)
ST1904	HYDAC 280D025WHC This product is not available in all regions of the world. Overall Height: 14.02 (356) Overall OD: 2.72 (69) End 1 ID: 1.30 (33)	ST1914	HYDAC 660D050WHC This product is not available in all regions of the world. Overall Height: 12.95 (329) Overall OD: 3.56 (91) End 1 ID: 1.83 (47)	ST1927HH	This product is not available in all regions of the world.
ST1905	HYDAC 280D050WHC This product is not available in all regions of the world. Overall Height: 14.02 (356) Overall OD: 2.72 (69) End 1 ID: 1.30 (33)	ST1915	HYDAC 660D100WHC This product is not available in all regions of the world. Overall Height: 12.95 (329) Overall OD: 3.56 (91) End 1 ID: 1.83 (47)	ST1928	INTERNORMEN 1E95010VG10EP This product is not available in all regions of the world. Overall Height: 13.78 (350) Overall OD: 5.59 (142) End 1 ID: 3.35 (85)

E. PRODUCT GUIDE

ST1930	EPPENSTEINER 1561P25A000P This product is not available in all regions of the world. Overall Height: 10.37 (264) Overall OD: 5.61 (143) End 1 ID: 3.62 (92)	ST1940	MAHLE PI23063RNSMX10 This product is not available in all regions of the world. Overall Height: 15.71 (399) Overall OD: 5.49 (140) End 1 ID: 2.70 (69)	ST1950	MAHLE PI15004RNNMIC25 This product is not available in all regions of the world. Overall Height: 3.90 (99) Overall OD: 2.28 (58) End 1 ID: 1.21 (31)
ST1931	INTERNORMEN 1NR6306VG10BP This product is not available in all regions of the world. Overall Height: 15.71 (399) Overall OD: 5.49 (140) End 1 ID: 2.70 (69)	ST1941	EPPENSTEINER 1361H10SLA000P This product is not available in all regions of the world. Overall Height: 9.09 (231) Overall OD: 4.02 (102) End 1 ID: 2.34 (60)	ST1951	MAHLE PI15006RNNMIC25 This product is not available in all regions of the world. Overall Height: 6.26 (159) Overall OD: 2.28 (58) End 1 ID: 1.21 (31)
ST1932	MAHLE PI72025DNSMXVST6 This product is not available in all regions of the world. Overall Height: 9.80 (249) Overall OD: 3.14 (80) End 1 ID: 1.54 (39)	ST1942	EPPENSTEINER 1361G25A000P This product is not available in all regions of the world. Overall Height: 9.09 (231) Overall OD: 4.02 (102) End 1 ID: 2.34 (60)	ST1952	MAHLE PI15010RNNMIC25 This product is not available in all regions of the world. Overall Height: 9.80 (249) Overall OD: 2.28 (58) End 1 ID: 1.24 (32)
ST1933HH	This product is not available in all regions of the world.	ST1943	MP FILTRI HP1351A10AN This product is not available in all regions of the world. Overall Height: 4.53 (115) Overall OD: 2.13 (54) End 1 ID: 1.02 (26)	ST1953	MAHLE PI15016RNNMIC25 This product is not available in all regions of the world. Overall Height: 6.26 (159) Overall OD: 4.31 (110) End 1 ID: 1.99 (51)
ST1934	EPPENSTEINER 2225G40A000P This product is not available in all regions of the world. Overall Height: 8.90 (226) Overall OD: 2.91 (74) End 1 ID: 1.56 (40)	ST1944	MAHLE PI13004RNNMIC10 This product is not available in all regions of the world. Overall Height: 3.90 (99) Overall OD: 2.28 (58) End 1 ID: 1.21 (31)	ST1954	MAHLE PI15025RNNMIC25 This product is not available in all regions of the world. Overall Height: 9.80 (249) Overall OD: 4.31 (110) End 1 ID: 1.99 (51)
ST1935	MP FILTRI HP0651A25AN This product is not available in all regions of the world. Overall Height: 3.35 (85) Overall OD: 1.85 (47) End 1 ID: 0.98 (25)	ST1945	MAHLE PI13006RNNMIC10 This product is not available in all regions of the world. Overall Height: 6.26 (159) Overall OD: 2.28 (58) End 1 ID: 1.21 (31)	ST1955	MAHLE PI15040RNNMIC25 This product is not available in all regions of the world. Overall Height: 9.80 (249) Overall OD: 5.49 (140) End 1 ID: 2.70 (69)
ST1936	SOFRANCE CH0609101481Y00 This product is not available in all regions of the world. Overall Height: 4.09 (104) Overall OD: 2.60 (66) End 1 ID: 0.87 (22)	ST1946	MAHLE PI13016RNNMIC10 This product is not available in all regions of the world. Overall Height: 6.26 (159) Overall OD: 4.31 (110) End 1 ID: 1.99 (51)	ST1956	MAHLE PI15063RNNMIC25 This product is not available in all regions of the world. Overall Height: 15.71 (399) Overall OD: 5.49 (140) End 1 ID: 2.70 (69)
ST1937	MAHLE PI13040RNNMIC10 This product is not available in all regions of the world. Overall Height: 9.80 (249) Overall OD: 5.49 (140) End 1 ID: 2.70 (69)	ST1947	MAHLE PI13025RNNMIC10 This product is not available in all regions of the world. Overall Height: 9.80 (249) Overall OD: 4.31 (110) End 1 ID: 1.99 (51)	ST1957	MAHLE PI21006RNSMX3 This product is not available in all regions of the world. Overall Height: 6.26 (159) Overall OD: 2.28 (58) End 1 ID: 1.21 (31)
ST1938	HYDAC 1320D005BN3HC This product is not available in all regions of the world. Overall Height: 25.59 (650) Overall OD: 3.56 (91) End 1 ID: 1.84 (47)	ST1948	HYDAC 1300R005BN3HCKB This product is not available in all regions of the world. Overall Height: 19.02 (483) Overall OD: 5.63 (143) End 1 ID: 3.78 (96)	ST1958	MAHLE PI21010RNSMX3 This product is not available in all regions of the world. Overall Height: 9.80 (249) Overall OD: 2.28 (58) End 1 ID: 1.21 (31)
ST1939	MAHLE PI23040RNSMX10 This product is not available in all regions of the world. Overall Height: 9.80 (249) Overall OD: 5.49 (140) End 1 ID: 2.70 (69)	ST1949	MAHLE PI13063RNNMIC10 This product is not available in all regions of the world. Overall Height: 15.71 (399) Overall OD: 5.49 (140) End 1 ID: 2.70 (69)	ST1959	MAHLE PI21016RNSMX3 This product is not available in all regions of the world. Overall Height: 6.26 (159) Overall OD: 4.31 (110) End 1 ID: 1.99 (51)

E. PRODUCT GUIDE

ST1960	<p>MAHLE PI21025RNSMX3 This product is not available in all regions of the world.</p> <p>Overall Height: 9.80 (249) Overall OD: 4.31 (110) End 1 ID: 1.99 (51)</p>	ST1970	<p>MAHLE PI23010RNSMX10 This product is not available in all regions of the world.</p> <p>Overall Height: 9.80 (249) Overall OD: 2.28 (58) End 1 ID: 1.21 (31)</p>	ST1980	<p>MAHLE PI25006RNSMX25 This product is not available in all regions of the world.</p> <p>Overall Height: 6.26 (159) Overall OD: 2.28 (58) End 1 ID: 1.21 (31)</p>
ST1961	<p>MAHLE PI21040RNSMX3 This product is not available in all regions of the world.</p> <p>Overall Height: 9.80 (249) Overall OD: 5.49 (140) End 1 ID: 2.70 (69)</p>	ST1971	<p>MAHLE PI23016RNSMX10 This product is not available in all regions of the world.</p> <p>Overall Height: 6.26 (159) Overall OD: 4.31 (110) End 1 ID: 1.99 (51)</p>	ST1981	<p>MAHLE PI25010RNSMX25 This product is not available in all regions of the world.</p> <p>Overall Height: 9.80 (249) Overall OD: 2.28 (58) End 1 ID: 1.21 (31)</p>
ST1962	<p>MAHLE PI21063RNSMX3 This product is not available in all regions of the world.</p> <p>Overall Height: 15.71 (399) Overall OD: 5.49 (140) End 1 ID: 2.70 (69)</p>	ST1972	<p>MAHLE PI23025RNSMX10 This product is not available in all regions of the world.</p> <p>Overall Height: 9.80 (249) Overall OD: 4.31 (110) End 1 ID: 1.99 (51)</p>	ST1982	<p>MAHLE PI25016RNSMX25 This product is not available in all regions of the world.</p> <p>Overall Height: 6.26 (159) Overall OD: 4.31 (110) End 1 ID: 1.99 (51)</p>
ST1963	<p>HYDAC 1300R005BN3HCB6 This product is not available in all regions of the world.</p> <p>Overall Height: 19.02 (483) Overall OD: 5.63 (143) BPV Setting: 87.02 (600) End 1 ID: 3.78 (96)</p>	ST1973	<p>MAHLE PI24004RNSMX16 This product is not available in all regions of the world.</p> <p>Overall Height: 3.90 (99) Overall OD: 2.28 (58) End 1 ID: 1.21 (31)</p>	ST1983	<p>MAHLE PI25025RNSMX25 This product is not available in all regions of the world.</p> <p>Overall Height: 9.80 (249) Overall OD: 4.31 (110) End 1 ID: 1.99 (51)</p>
ST1964	<p>MAHLE PI22010RNSMX6 This product is not available in all regions of the world.</p> <p>Overall Height: 9.80 (249) Overall OD: 2.28 (58) End 1 ID: 1.21 (31)</p>	ST1974	<p>MAHLE PI24006RNSMX16 This product is not available in all regions of the world.</p> <p>Overall Height: 6.26 (159) Overall OD: 2.28 (58) End 1 ID: 1.21 (31)</p>	ST1984	<p>MAHLE PI25040RNSMX25 This product is not available in all regions of the world.</p> <p>Overall Height: 9.80 (249) Overall OD: 5.49 (140) End 1 ID: 2.70 (69)</p>
ST1965	<p>MAHLE PI22016RNSMX6 This product is not available in all regions of the world.</p> <p>Overall Height: 6.26 (159) Overall OD: 4.31 (110) End 1 ID: 1.99 (51)</p>	ST1975	<p>MAHLE PI24010RNSMX16 This product is not available in all regions of the world.</p> <p>Overall Height: 9.80 (249) Overall OD: 2.28 (58) End 1 ID: 1.21 (31)</p>	ST1985	<p>MAHLE PI25063RNSMX25 This product is not available in all regions of the world.</p> <p>Overall Height: 15.71 (399) Overall OD: 5.49 (140) End 1 ID: 2.70 (69)</p>
ST1966	<p>MAHLE PI22025RNSMX6 This product is not available in all regions of the world.</p> <p>Overall Height: 9.80 (249) Overall OD: 4.31 (110) End 1 ID: 1.99 (51)</p>	ST1976	<p>MAHLE PI24016RNSMX16 This product is not available in all regions of the world.</p> <p>Overall Height: 6.26 (159) Overall OD: 4.31 (110) End 1 ID: 1.99 (51)</p>	ST1986	<p>MAHLE PI35004RNDRG25 This product is not available in all regions of the world.</p> <p>Overall Height: 3.90 (99) Overall OD: 2.28 (58) End 1 ID: 1.21 (31)</p>
ST1967	<p>MAHLE PI22040RNSMX6 This product is not available in all regions of the world.</p> <p>Overall Height: 9.80 (249) Overall OD: 5.49 (140) End 1 ID: 2.70 (69)</p>	ST1977	<p>MAHLE PI24025RNSMX16 This product is not available in all regions of the world.</p> <p>Overall Height: 9.80 (249) Overall OD: 4.31 (110) End 1 ID: 1.99 (51)</p>	ST1987	<p>MAHLE PI35006RNDRG25 This product is not available in all regions of the world.</p> <p>Overall Height: 6.26 (159) Overall OD: 2.28 (58) End 1 ID: 1.21 (31)</p>
ST1968	<p>HYDAC 660R005BN3HCKB This product is not available in all regions of the world.</p> <p>Overall Height: 13.15 (334) End 1 OD: 4.49 (114) End 2 OD: 5.49 (140) End 1 ID: 2.69 (68)</p>	ST1978	<p>MAHLE PI24040RNSMX16 This product is not available in all regions of the world.</p> <p>Overall Height: 9.80 (249) Overall OD: 5.49 (140) End 1 ID: 2.70 (69)</p>	ST1988	<p>MAHLE PI35010RNDRG25 This product is not available in all regions of the world.</p> <p>Overall Height: 9.80 (249) Overall OD: 2.28 (58) End 1 ID: 1.21 (31)</p>
ST1969	<p>MAHLE PI23006RNSMX10 This product is not available in all regions of the world.</p> <p>Overall Height: 6.26 (159) Overall OD: 2.28 (58) End 1 ID: 1.21 (31)</p>	ST1979	<p>MAHLE PI24063RNSMX16 This product is not available in all regions of the world.</p> <p>Overall Height: 15.71 (399) Overall OD: 5.49 (140) End 1 ID: 2.70 (69)</p>	ST1989	<p>MAHLE PI35016RNDRG25 This product is not available in all regions of the world.</p> <p>Overall Height: 6.26 (159) Overall OD: 4.31 (110) End 1 ID: 1.99 (51)</p>

E. PRODUCT GUIDE

<p>ST1990 MAHLE PI35025RNDRG25 This product is not available in all regions of the world.</p> <p>Overall Height: 9.80 (249) Overall OD: 4.31 (110) End 1 ID: 1.99 (51)</p>	<p>ST2068 HYDAC 30D100W This product is not available in all regions of the world.</p> <p>Overall Height: 3.70 (94) Overall OD: 1.38 (35) End 1 ID: 0.45 (11)</p>	<p>ST2078 STAUFF SE125B100B This product is not available in all regions of the world.</p> <p>Overall Height: 14.61 (371) Overall OD: 2.36 (60) End 1 ID: 1.30 (33)</p>
<p>ST1991 MAHLE PI35040RNDRG25 This product is not available in all regions of the world.</p> <p>Overall Height: 9.80 (249) Overall OD: 5.49 (140) End 1 ID: 2.70 (69)</p>	<p>ST2069 HYDAC 30D040W, HYDAC 30D050W, HYDAC 307511 This product is not available in all regions of the world.</p> <p>Overall Height: 3.70 (94) Overall OD: 1.38 (35) End 1 ID: 0.45 (11)</p>	<p>ST2079 HYDAC 280D040W This product is not available in all regions of the world.</p> <p>Overall Height: 14.61 (371) Overall OD: 2.36 (60) End 1 ID: 1.30 (33)</p>
<p>ST1992 MAHLE PI35063RNDRG25 This product is not available in all regions of the world.</p> <p>Overall Height: 15.71 (399) Overall OD: 5.49 (140) End 1 ID: 2.70 (69)</p>	<p>ST2070 HYDAC 60D040W, HYDAC 60D050W This product is not available in all regions of the world.</p> <p>Overall Height: 3.58 (91) Overall OD: 1.75 (45) End 1 ID: 0.83 (21)</p>	<p>ST2080 HYDAC 500D100W This product is not available in all regions of the world.</p> <p>Overall Height: 10.75 (273) Overall OD: 3.01 (77) End 1 ID: 1.84 (47)</p>
<p>ST1993 MAHLE PI36004RNDRG40 This product is not available in all regions of the world.</p> <p>Overall Height: 3.90 (99) Overall OD: 2.28 (58) End 1 ID: 1.21 (31)</p>	<p>ST2071 STAUFF SE014B50B This product is not available in all regions of the world.</p> <p>Overall Height: 3.58 (91) Overall OD: 1.75 (45) End 1 ID: 0.83 (21)</p>	<p>ST2081 HYDAC 500D40W This product is not available in all regions of the world.</p> <p>Overall Height: 10.75 (273) Overall OD: 3.01 (77) End 1 ID: 1.84 (47)</p>
<p>ST1994 MAHLE PI36006RNDRG40 This product is not available in all regions of the world.</p> <p>Overall Height: 6.26 (159) Overall OD: 2.28 (58) End 1 ID: 1.21 (31)</p>	<p>ST2072 HYDAC 110D100W This product is not available in all regions of the world.</p> <p>Overall Height: 6.22 (158) Overall OD: 1.75 (45) End 1 ID: 0.83 (21)</p>	<p>ST2082 HYDAC 110R100W This product is not available in all regions of the world.</p> <p>Overall Height: 6.69 (170) Overall OD: 1.75 (45) BPV Setting: 43.51 (300) End 1 ID: 0.83 (21)</p>
<p>ST1995 MAHLE PI36010RNDRG40 This product is not available in all regions of the world.</p> <p>Overall Height: 9.80 (249) Overall OD: 2.28 (58) End 1 ID: 1.21 (31)</p>	<p>ST2073 HYDAC 110D050W This product is not available in all regions of the world.</p> <p>Overall Height: 6.22 (158) Overall OD: 1.75 (45) End 1 ID: 0.83 (21)</p>	<p>ST2083 HYDAC 110R040W This product is not available in all regions of the world.</p> <p>Overall Height: 6.69 (170) Overall OD: 1.75 (45) BPV Setting: 43.51 (300) End 1 ID: 0.83 (21)</p>
<p>ST1996 MAHLE PI36016RNDRG40 This product is not available in all regions of the world.</p> <p>Overall Height: 6.26 (159) Overall OD: 4.31 (110) End 1 ID: 1.99 (51)</p>	<p>ST2074 HYDAC 140D100W This product is not available in all regions of the world.</p> <p>Overall Height: 7.87 (200) Overall OD: 1.75 (45) End 1 ID: 0.83 (21)</p>	<p>ST2084 HYDAC 1300R100W This product is not available in all regions of the world.</p> <p>Overall Height: 19.02 (483) Overall OD: 4.90 (125) BPV Setting: 43.51 (300) End 1 ID: 3.78 (96)</p>
<p>ST1997 MAHLE PI36025RNDRG40 This product is not available in all regions of the world.</p> <p>Overall Height: 9.80 (249) Overall OD: 4.31 (110) End 1 ID: 1.99 (51)</p>	<p>ST2075 HYDAC 140D040W This product is not available in all regions of the world.</p> <p>Overall Height: 7.87 (200) Overall OD: 1.75 (45) End 1 ID: 0.83 (21)</p>	<p>ST2085 HYDAC 1300R040W This product is not available in all regions of the world.</p> <p>Overall Height: 19.02 (483) Overall OD: 4.90 (125) BPV Setting: 43.51 (300) End 1 ID: 3.78 (96)</p>
<p>ST1998 MAHLE PI36040RNDRG40 This product is not available in all regions of the world.</p> <p>Overall Height: 9.80 (249) Overall OD: 5.49 (140) End 1 ID: 2.70 (69)</p>	<p>ST2076 HYDAC 160D100W, HYDAC 304532 This product is not available in all regions of the world.</p> <p>Overall Height: 5.12 (130) Overall OD: 2.36 (60) End 1 ID: 1.30 (33)</p>	<p>ST2086 STAUFF RE300B50B This product is not available in all regions of the world.</p> <p>Overall Height: 19.02 (483) Overall OD: 4.90 (125) BPV Setting: 43.51 (300) End 1 ID: 3.78 (96)</p>
<p>ST1999 MAHLE PI36063RNDRG40 This product is not available in all regions of the world.</p> <p>Overall Height: 15.71 (399) Overall OD: 5.49 (140) End 1 ID: 2.70 (69)</p>	<p>ST2077 STAUFF SE030B50B This product is not available in all regions of the world.</p> <p>Overall Height: 5.12 (130) Overall OD: 2.36 (60) End 1 ID: 1.30 (33)</p>	

E. PRODUCT GUIDE

ST2087	STAUFF RE045B100B This product is not available in all regions of the world. Overall Height: 5.67 (144) Overall OD: 2.36 (60) BPV Setting: 43.51 (300) End 1 ID: 1.27 (32)	ST2097	HYDAC 330R050W This product is not available in all regions of the world. Overall Height: 7.68 (195) Overall OD: 3.01 (77) BPV Setting: 43.51 (300) End 1 ID: 1.84 (47)	ST2106	HYDAC 950R040W This product is not available in all regions of the world. Overall Height: 14.33 (364) Overall OD: 4.90 (125) BPV Setting: 43.51 (300) End 1 ID: 3.78 (96)
ST2088	STAUFF RE045B0B This product is not available in all regions of the world. Overall Height: 5.67 (144) Overall OD: 2.36 (60) BPV Setting: 43.51 (300) End 1 ID: 1.27 (32)	ST2098	HYDAC 500R100W This product is not available in all regions of the world. Overall Height: 10.87 (276) Overall OD: 3.01 (77) BPV Setting: 43.51 (300) End 1 ID: 1.84 (47)	ST2107	HYDAC 165R003BN3HC This product is not available in all regions of the world. Overall Height: 8.98 (228) Overall OD: 2.36 (60) BPV Setting: 43.51 (300) End 1 ID: 1.27 (32)
ST2089	HYDAC 240R100W This product is not available in all regions of the world. Overall Height: 7.99 (203) Overall OD: 2.36 (60) BPV Setting: 43.51 (300) End 1 ID: 1.27 (32)	ST2099	HYDAC 500R040W This product is not available in all regions of the world. Overall Height: 10.87 (276) Overall OD: 3.01 (77) BPV Setting: 43.51 (300) End 1 ID: 1.84 (47)	ST2108	HYDAC 165R005BN3HC This product is not available in all regions of the world. Overall Height: 8.98 (228) Overall OD: 2.36 (60) BPV Setting: 43.51 (300) End 1 ID: 1.27 (32)
ST2090	HYDAC 240R040W This product is not available in all regions of the world. Overall Height: 7.99 (203) Overall OD: 2.36 (60) BPV Setting: 43.51 (300) End 1 ID: 1.27 (32)	ST2100	STAUFF RE160B100B This product is not available in all regions of the world. Overall Height: 13.15 (334) Overall OD: 3.76 (96) BPV Setting: 43.51 (300) End 1 ID: 2.63 (67)	ST2109	HYDAC 2600R005BN3HCB6, HYDAC 2600R005BN3HCSO106 This product is not available in all regions of the world. Overall Height: 36.30 (922) Overall OD: 5.63 (143) BPV Setting: 87.02 (600) End 1 ID: 3.78 (96)
ST2091	HYDAC 240R050W This product is not available in all regions of the world. Overall Height: 7.99 (203) Overall OD: 2.36 (60) BPV Setting: 43.51 (300) End 1 ID: 1.27 (32)	ST2101	HYDAC 660R040W This product is not available in all regions of the world. Overall Height: 13.15 (334) Overall OD: 3.76 (96) BPV Setting: 43.51 (300) End 1 ID: 2.63 (67)	ST2110	HYDAC 660R005BN3HCB6 This product is not available in all regions of the world. Overall Height: 13.15 (334) Overall OD: 4.49 (114) BPV Setting: 87.02 (600) End 1 ID: 2.69 (68)
ST2092	HYDAC 2600R100W This product is not available in all regions of the world. Overall Height: 36.30 (922) Overall OD: 4.90 (125) BPV Setting: 43.51 (300) End 1 ID: 3.78 (96)	ST2102	HYDAC 850R100W This product is not available in all regions of the world. Overall Height: 16.30 (414) Overall OD: 3.76 (96) BPV Setting: 43.51 (300) End 1 ID: 2.63 (67)	ST2111	HYDAC 950R10BN3HCB0 This product is not available in all regions of the world. Overall Height: 14.33 (364) Overall OD: 5.63 (143) End 1 ID: 3.78 (96)
ST2093	HYDAC 2600R040W This product is not available in all regions of the world. Overall Height: 36.30 (922) Overall OD: 4.90 (125) BPV Setting: 43.51 (300) End 1 ID: 3.78 (96)	ST2103	HYDAC 850R050W This product is not available in all regions of the world. Overall Height: 16.30 (414) Overall OD: 3.76 (96) BPV Setting: 43.51 (300) End 1 ID: 2.63 (67)	ST2112	HYDAC 140D005BN3HC, HYDAC 309503 This product is not available in all regions of the world. Overall Height: 7.60 (193) Overall OD: 1.85 (47) End 1 ID: 0.83 (21)
ST2095	STAUFF RE090B100B This product is not available in all regions of the world. Overall Height: 7.68 (195) Overall OD: 3.01 (77) BPV Setting: 43.51 (300) End 1 ID: 1.84 (47)	ST2104	STAUFF RE200B50B This product is not available in all regions of the world. Overall Height: 16.30 (414) Overall OD: 3.76 (96) BPV Setting: 43.51 (300) End 1 ID: 2.63 (67)	ST2113	HYDAC 140D020BN3HC, HYDAC 308716, HYDAC 309502 This product is not available in all regions of the world. Overall Height: 7.60 (193) Overall OD: 1.85 (47) End 1 ID: 0.83 (21)
ST2096	HYDAC 330R040W This product is not available in all regions of the world. Overall Height: 7.68 (195) Overall OD: 3.01 (77) BPV Setting: 43.51 (300) End 1 ID: 1.84 (47)	ST2105	STAUFF RE250B00B This product is not available in all regions of the world. Overall Height: 14.33 (364) Overall OD: 4.90 (125) BPV Setting: 43.51 (300) End 1 ID: 3.78 (96)	ST2114	HYDAC 330R010BN3HCB6 This product is not available in all regions of the world. Overall Height: 7.68 (195) Overall OD: 3.74 (95) BPV Setting: 87.02 (600) End 1 ID: 1.91 (49)

E. PRODUCT GUIDE

<p>ST2115 HYDAC 330R020BN3HCB6 This product is not available in all regions of the world.</p> <p>Overall Height: 7.68 (195) Overall OD: 3.74 (95) BPV Setting: 87.02 (600) End 1 ID: 1.91 (49)</p>	<p>ST2124 MAHLE PI24025DNSMX16 This product is not available in all regions of the world.</p> <p>Overall Height: 9.80 (249) Overall OD: 3.14 (80) End 1 ID: 1.54 (39)</p>	<p>ST2134 MAHLE PI13063DNMIC10 This product is not available in all regions of the world.</p> <p>Overall Height: 15.71 (399) Overall OD: 3.14 (80) End 1 ID: 1.50 (38)</p>
<p>ST2116 This product is not available in all regions of the world.</p> <p>Overall Height: 7.68 (195) Overall OD: 3.01 (77) BPV Setting: 43.51 (300) End 1 ID: 1.84 (47)</p>	<p>ST2125 INTERNORMEN 1NL25025VG30EP This product is not available in all regions of the world.</p> <p>Overall Height: 9.80 (249) Overall OD: 3.14 (80) End 1 ID: 1.54 (39)</p>	<p>ST2135 MAHLE PI13100DNMIC10 This product is not available in all regions of the world.</p> <p>Overall Height: 24.76 (629) Overall OD: 3.93 (100) End 1 ID: 2.34 (59)</p>
<p>ST2117 This product is not available in all regions of the world.</p> <p>Overall Height: 7.68 (195) Overall OD: 3.01 (77) BPV Setting: 43.51 (300) End 1 ID: 1.84 (47)</p>	<p>ST2126 EPPENSTEINER 1901G25A000P This product is not available in all regions of the world.</p> <p>Overall Height: 15.22 (387) Overall OD: 5.61 (143) End 1 ID: 3.62 (92)</p>	<p>ST2136 MAHLE PI15004DNMIC25 This product is not available in all regions of the world.</p> <p>Overall Height: 3.90 (99) Overall OD: 1.76 (45) End 1 ID: 0.83 (21)</p>
<p>ST2118 This product is not available in all regions of the world.</p> <p>Overall Height: 19.02 (483) Overall OD: 4.90 (125) BPV Setting: 43.51 (300) End 1 ID: 3.78 (96)</p>	<p>ST2127 PARKER GO1442Q This product is not available in all regions of the world.</p> <p>Overall Height: 5.35 (136) Overall OD: 2.36 (60) End 1 ID: 0.98 (25)</p>	<p>ST2137 MAHLE PI15006DNMIC25 This product is not available in all regions of the world.</p> <p>Overall Height: 6.26 (159) Overall OD: 1.76 (45) End 1 ID: 0.83 (21)</p>
<p>ST2119 This product is not available in all regions of the world.</p> <p>Overall Height: 19.02 (483) Overall OD: 4.90 (125) BPV Setting: 43.51 (300) End 1 ID: 3.78 (96)</p>	<p>ST2128 MAHLE PI13004DNMIC10 This product is not available in all regions of the world.</p> <p>Overall Height: 3.90 (99) Overall OD: 1.76 (45) End 1 ID: 0.83 (21)</p>	<p>ST2138 MAHLE PI15010DNMIC25 This product is not available in all regions of the world.</p> <p>Overall Height: 9.80 (249) Overall OD: 1.76 (45) End 1 ID: 0.83 (21)</p>
<p>ST2120 HYDAC 1300R003BN3HCB0 This product is not available in all regions of the world.</p> <p>Overall Height: 19.02 (483) Overall OD: 5.63 (143) End 1 ID: 3.78 (96)</p>	<p>ST2129 MAHLE PI13006DNMIC10 This product is not available in all regions of the world.</p> <p>Overall Height: 6.26 (159) Overall OD: 1.76 (45) End 1 ID: 0.83 (21)</p>	<p>ST2139 MAHLE PI15016DNMIC25 This product is not available in all regions of the world.</p> <p>Overall Height: 6.26 (159) Overall OD: 3.14 (80) End 1 ID: 1.50 (38)</p>
<p>ST2121 HYDAC 1300R020BN3HCB0 This product is not available in all regions of the world.</p> <p>Overall Height: 19.02 (483) Overall OD: 5.63 (143) End 1 ID: 3.78 (96)</p>	<p>ST2130 MAHLE PI13010DNMIC10 This product is not available in all regions of the world.</p> <p>Overall Height: 9.80 (249) Overall OD: 1.76 (45) End 1 ID: 0.83 (21)</p>	<p>ST2140 MAHLE PI15025DNMIC25 This product is not available in all regions of the world.</p> <p>Overall Height: 9.80 (249) Overall OD: 3.14 (80) End 1 ID: 1.50 (38)</p>
<p>ST2122 HYDAC 1300R010BN3HCB6 This product is not available in all regions of the world.</p> <p>Overall Height: 19.02 (483) Overall OD: 5.63 (143) BPV Setting: 87.02 (600) End 1 ID: 3.78 (96)</p>	<p>ST2131 MAHLE PI13016DNMIC10 This product is not available in all regions of the world.</p> <p>Overall Height: 6.26 (159) Overall OD: 3.14 (80) End 1 ID: 1.50 (38)</p>	<p>ST2141 MAHLE PI15040DNMIC25 This product is not available in all regions of the world.</p> <p>Overall Height: 15.71 (399) Overall OD: 3.14 (80) End 1 ID: 1.50 (38)</p>
<p>ST2123 INTERNORMEN 1NL25010VG30EP This product is not available in all regions of the world.</p> <p>Overall Height: 9.80 (249) Overall OD: 3.14 (80) End 1 ID: 1.54 (39)</p>	<p>ST2132 MAHLE PI13025DNMIC10 This product is not available in all regions of the world.</p> <p>Overall Height: 9.80 (249) Overall OD: 3.14 (80) End 1 ID: 1.50 (38)</p>	<p>ST2142 MAHLE PI15063DNMIC25 This product is not available in all regions of the world.</p> <p>Overall Height: 15.71 (399) Overall OD: 3.93 (100) End 1 ID: 2.34 (59)</p>
<p>ST2124 MAHLE PI13040DNMIC10 This product is not available in all regions of the world.</p> <p>Overall Height: 15.71 (399) Overall OD: 3.14 (80) End 1 ID: 1.50 (38)</p>	<p>ST2133 MAHLE PI13040DNMIC10 This product is not available in all regions of the world.</p> <p>Overall Height: 15.71 (399) Overall OD: 3.14 (80) End 1 ID: 1.50 (38)</p>	<p>ST2143 MAHLE PI15100DNMIC25 This product is not available in all regions of the world.</p> <p>Overall Height: 24.76 (629) Overall OD: 3.93 (100) End 1 ID: 2.34 (59)</p>

E. PRODUCT GUIDE

ST2144	MAHLE PI21004DNSMX3 This product is not available in all regions of the world. Overall Height: 3.90 (99) Overall OD: 1.76 (45) End 1 ID: 0.83 (21)	ST2154	MAHLE PI22010DNSMX6 This product is not available in all regions of the world. Overall Height: 9.80 (249) Overall OD: 1.76 (45) End 1 ID: 0.83 (21)	ST2164	MAHLE PI23040DNSMX10 This product is not available in all regions of the world. Overall Height: 15.71 (399) Overall OD: 3.14 (80) End 1 ID: 1.50 (38)
ST2145	MAHLE PI21006DNSMX3 This product is not available in all regions of the world. Overall Height: 6.26 (159) Overall OD: 1.76 (45) End 1 ID: 0.83 (21)	ST2155	MAHLE PI22016DNSMX6 This product is not available in all regions of the world. Overall Height: 6.26 (159) Overall OD: 3.14 (80) End 1 ID: 1.50 (38)	ST2165	MAHLE PI23063DNSMX10 This product is not available in all regions of the world. Overall Height: 15.71 (399) Overall OD: 3.93 (100) End 1 ID: 2.34 (59)
ST2146	MAHLE PI21010DNSMX3 This product is not available in all regions of the world. Overall Height: 9.80 (249) Overall OD: 1.76 (45) End 1 ID: 0.83 (21)	ST2156	MAHLE PI22025DNSMX6 This product is not available in all regions of the world. Overall Height: 9.80 (249) Overall OD: 3.14 (80) End 1 ID: 1.50 (38)	ST2166	MAHLE PI23100DNSMX10 This product is not available in all regions of the world. Overall Height: 24.76 (629) Overall OD: 3.93 (100) End 1 ID: 2.34 (59)
ST2147	MAHLE PI21016DNSMX3 This product is not available in all regions of the world. Overall Height: 6.26 (159) Overall OD: 3.14 (80) End 1 ID: 1.50 (38)	ST2157	MAHLE PI22040DNSMX6 This product is not available in all regions of the world. Overall Height: 15.71 (399) Overall OD: 3.14 (80) End 1 ID: 1.50 (38)	ST2167	MAHLE PI24004DNSMX16 This product is not available in all regions of the world. Overall Height: 3.90 (99) Overall OD: 1.76 (45) End 1 ID: 0.83 (21)
ST2148	MAHLE PI21025DNSMX3 This product is not available in all regions of the world. Overall Height: 9.80 (249) Overall OD: 3.14 (80) End 1 ID: 1.50 (38)	ST2158	MAHLE PI22063DNSMX6 This product is not available in all regions of the world. Overall Height: 15.71 (399) Overall OD: 3.93 (100) End 1 ID: 2.34 (59)	ST2168	MAHLE PI24006DNSMX16 This product is not available in all regions of the world. Overall Height: 6.26 (159) Overall OD: 1.76 (45) End 1 ID: 0.83 (21)
ST2149	MAHLE PI21040DNSMX3 This product is not available in all regions of the world. Overall Height: 15.71 (399) Overall OD: 3.14 (80) End 1 ID: 1.50 (38)	ST2159	MAHLE PI22100DNSMX6 This product is not available in all regions of the world. Overall Height: 24.76 (629) Overall OD: 3.93 (100) End 1 ID: 2.34 (59)	ST2169	MAHLE PI24010DNSMX16 This product is not available in all regions of the world. Overall Height: 9.80 (249) Overall OD: 1.76 (45) End 1 ID: 0.83 (21)
ST2150	MAHLE PI21063DNSMX3 This product is not available in all regions of the world. Overall Height: 15.71 (399) Overall OD: 3.93 (100) End 1 ID: 2.34 (59)	ST2160	MAHLE PI23004DNSMX10 This product is not available in all regions of the world. Overall Height: 3.90 (99) Overall OD: 1.76 (45) End 1 ID: 0.83 (21)	ST2170	MAHLE PI24016DNSMX16 This product is not available in all regions of the world. Overall Height: 6.26 (159) Overall OD: 3.14 (80) End 1 ID: 1.50 (38)
ST2151	MAHLE PI21100DNSMX3 This product is not available in all regions of the world. Overall Height: 24.76 (629) Overall OD: 3.93 (100) End 1 ID: 2.34 (59)	ST2161	MAHLE PI23006DNSMX10 This product is not available in all regions of the world. Overall Height: 6.26 (159) Overall OD: 1.76 (45) End 1 ID: 0.83 (21)	ST2171	MAHLE PI24040DNSMX16 This product is not available in all regions of the world. Overall Height: 15.71 (399) Overall OD: 3.14 (80) End 1 ID: 1.50 (38)
ST2152	MAHLE PI22004DNSMX6 This product is not available in all regions of the world. Overall Height: 3.90 (99) Overall OD: 1.76 (45) End 1 ID: 0.83 (21)	ST2162	MAHLE PI23010DNSMX10 This product is not available in all regions of the world. Overall Height: 9.80 (249) Overall OD: 1.76 (45) End 1 ID: 0.83 (21)	ST2172	MAHLE PI24063DNSMX16 This product is not available in all regions of the world. Overall Height: 15.71 (399) Overall OD: 3.93 (100) End 1 ID: 2.34 (59)
ST2153	MAHLE PI22006DNSMX6 This product is not available in all regions of the world. Overall Height: 6.26 (159) Overall OD: 1.76 (45) End 1 ID: 0.83 (21)	ST2163	MAHLE PI23016DNSMX10 This product is not available in all regions of the world. Overall Height: 6.26 (159) Overall OD: 3.14 (80) End 1 ID: 1.50 (38)	ST2173	MAHLE PI24100DNSMX16 This product is not available in all regions of the world. Overall Height: 24.76 (629) Overall OD: 3.93 (100) End 1 ID: 2.34 (59)

E. PRODUCT GUIDE

<p>ST2174 MAHLE PI25004DNSMX25 This product is not available in all regions of the world.</p> <p>Overall Height: 3.90 (99) Overall OD: 1.76 (45) End 1 ID: 0.83 (21)</p>	<p>ST2184 MAHLE PI71016DNSMXVST3 This product is not available in all regions of the world.</p> <p>Overall Height: 6.26 (159) Overall OD: 3.14 (80) End 1 ID: 1.50 (38)</p>	<p>ST2195 MAHLE PI72100DNSMXVST6 This product is not available in all regions of the world.</p> <p>Overall Height: 24.76 (629) Overall OD: 3.93 (100) End 1 ID: 2.34 (59)</p>
<p>ST2175 MAHLE PI25006DNSMX25 This product is not available in all regions of the world.</p> <p>Overall Height: 6.26 (159) Overall OD: 1.76 (45) End 1 ID: 0.83 (21)</p>	<p>ST2185 MAHLE PI71025DNSMXVST3 This product is not available in all regions of the world.</p> <p>Overall Height: 9.80 (249) Overall OD: 3.14 (80) End 1 ID: 1.50 (38)</p>	<p>ST2196 MAHLE PI73004DNSMXVST10 This product is not available in all regions of the world.</p> <p>Overall Height: 3.90 (99) Overall OD: 1.75 (45) End 1 ID: 0.83 (21)</p>
<p>ST2176 MAHLE PI25010DNSMX25 This product is not available in all regions of the world.</p> <p>Overall Height: 9.80 (249) Overall OD: 1.76 (45) End 1 ID: 0.83 (21)</p>	<p>ST2186 MAHLE PI71040DNSMXVST3 This product is not available in all regions of the world.</p> <p>Overall Height: 15.71 (399) Overall OD: 3.14 (80) End 1 ID: 1.50 (38)</p>	<p>ST2197 MAHLE PI73006DNSMXVST10 This product is not available in all regions of the world.</p> <p>Overall Height: 6.26 (159) Overall OD: 1.75 (45) End 1 ID: 0.83 (21)</p>
<p>ST2177 MAHLE PI25016DNSMX25 This product is not available in all regions of the world.</p> <p>Overall Height: 6.26 (159) Overall OD: 3.14 (80) End 1 ID: 1.50 (38)</p>	<p>ST2187 MAHLE PI71063DNSMXVST3 This product is not available in all regions of the world.</p> <p>Overall Height: 15.71 (399) Overall OD: 3.93 (100) End 1 ID: 2.34 (59)</p>	<p>ST2198 MAHLE PI73010DNSMXVST10 This product is not available in all regions of the world.</p> <p>Overall Height: 9.80 (249) Overall OD: 1.75 (45) End 1 ID: 0.83 (21)</p>
<p>ST2178 MAHLE PI25040DNSMX25 This product is not available in all regions of the world.</p> <p>Overall Height: 15.71 (399) Overall OD: 3.14 (80) End 1 ID: 1.50 (38)</p>	<p>ST2188 MAHLE PI71100DNSMXVST3 This product is not available in all regions of the world.</p> <p>Overall Height: 24.76 (629) Overall OD: 3.93 (100) End 1 ID: 2.34 (59)</p>	<p>ST2199 MAHLE PI73016DNSMXVST10 This product is not available in all regions of the world.</p> <p>Overall Height: 6.26 (159) Overall OD: 3.14 (80) End 1 ID: 1.50 (38)</p>
<p>ST2179 MAHLE PI25063DNSMX25 This product is not available in all regions of the world.</p> <p>Overall Height: 15.71 (399) Overall OD: 3.93 (100) End 1 ID: 2.34 (59)</p>	<p>ST2189 MAHLE PI72004DNSMXVST6 This product is not available in all regions of the world.</p> <p>Overall Height: 3.90 (99) Overall OD: 1.75 (45) End 1 ID: 0.83 (21)</p>	<p>ST2200 MAHLE PI73025DNSMXVST10 This product is not available in all regions of the world.</p> <p>Overall Height: 9.80 (249) Overall OD: 3.14 (80) End 1 ID: 1.50 (38)</p>
<p>ST2180 MAHLE PI25100DNSMX25 This product is not available in all regions of the world.</p> <p>Overall Height: 24.76 (629) Overall OD: 3.93 (100) End 1 ID: 2.34 (59)</p>	<p>ST2190 MAHLE PI72006DNSMXVST6 This product is not available in all regions of the world.</p> <p>Overall Height: 6.26 (159) Overall OD: 1.75 (45) End 1 ID: 0.83 (21)</p>	<p>ST2201 MAHLE PI73040DNSMXVST10 This product is not available in all regions of the world.</p> <p>Overall Height: 15.71 (399) Overall OD: 3.14 (80) End 1 ID: 1.50 (38)</p>
<p>ST2181 MAHLE PI71004DNSMXVST3 This product is not available in all regions of the world.</p> <p>Overall Height: 3.90 (99) Overall OD: 1.75 (45) End 1 ID: 0.83 (21)</p>	<p>ST2191 MAHLE PI72010DNSMXVST6 This product is not available in all regions of the world.</p> <p>Overall Height: 9.80 (249) Overall OD: 1.75 (45) End 1 ID: 0.83 (21)</p>	<p>ST2202 MAHLE PI73063DNSMXVST10 This product is not available in all regions of the world.</p> <p>Overall Height: 15.71 (399) Overall OD: 3.93 (100) End 1 ID: 2.34 (59)</p>
<p>ST2182 MAHLE PI71006DNSMXVST3 This product is not available in all regions of the world.</p> <p>Overall Height: 6.26 (159) Overall OD: 1.75 (45) End 1 ID: 0.83 (21)</p>	<p>ST2192 MAHLE PI72016DNSMXVST6 This product is not available in all regions of the world.</p> <p>Overall Height: 6.26 (159) Overall OD: 3.14 (80) End 1 ID: 1.50 (38)</p>	<p>ST2203 MAHLE PI73100DNSMXVST10 This product is not available in all regions of the world.</p> <p>Overall Height: 24.76 (629) Overall OD: 3.93 (100) End 1 ID: 2.34 (59)</p>
<p>ST2183 MAHLE PI71010DNSMXVST3 This product is not available in all regions of the world.</p> <p>Overall Height: 9.80 (249) Overall OD: 1.75 (45) End 1 ID: 0.83 (21)</p>	<p>ST2193 MAHLE PI72040DNSMXVST6 This product is not available in all regions of the world.</p> <p>Overall Height: 15.71 (399) Overall OD: 3.14 (80) End 1 ID: 1.50 (38)</p>	
	<p>ST2194 MAHLE PI72063DNSMXVST6 This product is not available in all regions of the world.</p> <p>Overall Height: 15.71 (399) Overall OD: 3.93 (100) End 1 ID: 2.34 (59)</p>	

















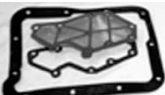

E. PRODUCT GUIDE

ST2204	MAHLE PI74004DNSMXVST16 This product is not available in all regions of the world. Overall Height: 3.90 (99) Overall OD: 1.75 (45) End 1 ID: 0.83 (21)	ST2213	MAHLE PI75006DNSMXVST25 This product is not available in all regions of the world. Overall Height: 6.26 (159) Overall OD: 1.75 (45) End 1 ID: 0.83 (21)	ST2222	INTERNORMEN 1E42510VG16EP This product is not available in all regions of the world. Overall Height: 12.01 (305) Overall OD: 3.27 (83) End 1 ID: 1.77 (45)
ST2205	MAHLE PI74006DNSMXVST16 This product is not available in all regions of the world. Overall Height: 6.26 (159) Overall OD: 1.75 (45) End 1 ID: 0.83 (21)	ST2214	MAHLE PI75010DNSMXVST25 This product is not available in all regions of the world. Overall Height: 9.80 (249) Overall OD: 1.75 (45) End 1 ID: 0.83 (21)	ST2223	HYDAC 160D200W This product is not available in all regions of the world. Overall Height: 5.12 (130) Overall OD: 2.36 (60) End 1 ID: 1.30 (33)
ST2206	MAHLE PI74010DNSMXVST16 Overall Height: 9.80 (249) Overall OD: 1.75 (45) End 1 ID: 0.83 (21)	ST2215	MAHLE PI75016DNSMXVST25 This product is not available in all regions of the world. Overall Height: 6.26 (159) Overall OD: 3.14 (80) End 1 ID: 1.50 (38)	ST2224	HYDAC 330D200W This product is not available in all regions of the world. Overall Height: 7.09 (180) Overall OD: 3.01 (77) End 1 ID: 1.84 (47)
ST2207	MAHLE PI74016DNSMXVST16 This product is not available in all regions of the world. Overall Height: 6.26 (159) Overall OD: 3.14 (80) End 1 ID: 1.50 (38)	ST2216	MAHLE PI75025DNSMXVST25 This product is not available in all regions of the world. Overall Height: 9.80 (249) Overall OD: 3.14 (80) End 1 ID: 1.50 (38)	ST2225	HYDAC 330R200W This product is not available in all regions of the world. Overall Height: 7.68 (195) Overall OD: 3.01 (77) BPV Setting: 43.51 (300) End 1 ID: 1.84 (47)
ST2208	MAHLE PI74025DNSMXVST16 This product is not available in all regions of the world. Overall Height: 9.80 (249) Overall OD: 3.14 (80) End 1 ID: 1.50 (38)	ST2217	MAHLE PI75040DNSMXVST25 This product is not available in all regions of the world. Overall Height: 15.71 (399) Overall OD: 3.14 (80) End 1 ID: 1.50 (38)	ST2226	EPPENSTEINER 1360P1000P This product is not available in all regions of the world. Overall Height: 8.94 (227) Overall OD: 4.02 (102) End 1 ID: 2.48 (63)
ST2209	MAHLE PI74040DNSMXVST16 This product is not available in all regions of the world. Overall Height: 15.71 (399) Overall OD: 3.14 (80) End 1 ID: 1.50 (38)	ST2218	MAHLE PI75063DNSMXVST25 This product is not available in all regions of the world. Overall Height: 15.71 (399) Overall OD: 3.93 (100) End 1 ID: 2.34 (59)	ST2227	HYDAC 75D003BNHC This product is not available in all regions of the world. Overall Height: 6.73 (171) Overall OD: 2.24 (57) End 1 ID: 0.97 (25)
ST2210	MAHLE PI74063DNSMXVST16 This product is not available in all regions of the world. Overall Height: 15.71 (399) Overall OD: 3.93 (100) End 1 ID: 2.34 (59)	ST2219	MAHLE PI75100DNSMXVST25 This product is not available in all regions of the world. Overall Height: 24.76 (629) Overall OD: 3.93 (100) End 1 ID: 2.34 (59)	ST2228	This product is not available in all regions of the world. Overall Height: 6.73 (171) Overall OD: 2.24 (57) End 1 ID: 0.97 (25)
ST2211	MAHLE PI74100DNSMXVST16 This product is not available in all regions of the world. Overall Height: 24.76 (629) Overall OD: 3.93 (100) End 1 ID: 2.34 (59)	ST2220	INTERNORMEN 1E24010VG30EP This product is not available in all regions of the world. Overall Height: 9.02 (229) Overall OD: 2.36 (60) End 1 ID: 1.30 (33)	ST2229	HYDAC 75D010BNHC This product is not available in all regions of the world. Overall Height: 6.73 (171) Overall OD: 2.24 (57) End 1 ID: 0.97 (25)
ST2212	MAHLE PI75004DNSMXVST25 This product is not available in all regions of the world. Overall Height: 3.90 (99) Overall OD: 1.75 (45) End 1 ID: 0.83 (21)	ST2221	INTERNORMEN 1E36010VG30EP This product is not available in all regions of the world. Overall Height: 12.13 (308) Overall OD: 2.36 (60) End 1 ID: 1.30 (33)	ST2230	HYDAC 75D020BNHC, HYDAC 1262051 This product is not available in all regions of the world. Overall Height: 6.73 (171) Overall OD: 2.24 (57) End 1 ID: 0.97 (25)
				ST2231	EPPENSTEINER 1561H20SLA000P This product is not available in all regions of the world. Overall Height: 10.37 (264) Overall OD: 5.61 (143) End 1 ID: 3.62 (92)



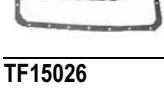



































E. PRODUCT GUIDE

<p>ST2232 EPPENSTEINER 1561H10SLA000P This product is not available in all regions of the world.</p> <p>Overall Height: 10.37 (264) Overall OD: 5.61 (143) End 1 ID: 3.62 (92)</p>	<p>ST2241 INTERNORMEN 1NR10003VG10BP This product is not available in all regions of the world.</p> <p>Overall Height: 15.71 (399) Overall OD: 6.28 (160) End 1 ID: 3.48 (88)</p>	<p>ST2249 INTERNORMEN 1E12025VG16SP This product is not available in all regions of the world.</p> <p>Overall Height: 6.73 (171) Overall OD: 2.17 (55) BPV Setting: 29.01 (200) End 1 ID: 1.02 (26)</p>
<p>ST2233 INTERNORMEN 1E9010VGHREP This product is not available in all regions of the world.</p> <p>Overall Height: 6.89 (175) Overall OD: 1.75 (45) End 1 ID: 0.83 (21)</p>	<p>ST2242 INTERNORMEN 1NR10006VG10BP This product is not available in all regions of the world.</p> <p>Overall Height: 15.71 (399) Overall OD: 6.28 (160) End 1 ID: 3.48 (88)</p>	<p>ST2250 INTERNORMEN 1E12010P16SP This product is not available in all regions of the world.</p> <p>Overall Height: 6.73 (171) Overall OD: 2.17 (55) BPV Setting: 29.01 (200) End 1 ID: 1.02 (26)</p>
<p>ST2234 EPPENSTEINER 11801P10A000P This product is not available in all regions of the world.</p> <p>Overall Height: 29.98 (762) Overall OD: 5.61 (143) End 1 ID: 3.62 (92)</p>	<p>ST2243 INTERNORMEN 1NR100010VG10BP This product is not available in all regions of the world.</p> <p>Overall Height: 15.71 (399) Overall OD: 6.28 (160) End 1 ID: 3.48 (88)</p>	<p>ST2251 INTERNORMEN 1E12025P16SP This product is not available in all regions of the world.</p> <p>Overall Height: 6.73 (171) Overall OD: 2.17 (55) BPV Setting: 29.01 (200) End 1 ID: 1.02 (26)</p>
<p>ST2235 EPPENSTEINER 11801P20A000P This product is not available in all regions of the world.</p> <p>Overall Height: 29.98 (762) Overall OD: 5.61 (143) End 1 ID: 3.62 (92)</p>	<p>ST2244 INTERNORMEN 1NR100025VG10BP This product is not available in all regions of the world.</p> <p>Overall Height: 15.71 (399) Overall OD: 6.28 (160) End 1 ID: 3.48 (88)</p>	<p>ST2252 INTERNORMEN 1E12025G16EP This product is not available in all regions of the world.</p> <p>Overall Height: 6.61 (168) Overall OD: 2.17 (55) End 1 ID: 1.02 (26)</p>
<p>ST2236 EPPENSTEINER 11801H10SLA000P This product is not available in all regions of the world.</p> <p>Overall Height: 29.98 (762) Overall OD: 5.61 (143) End 1 ID: 3.62 (92)</p>	<p>ST2245 INTERNORMEN 1E12025G16SP This product is not available in all regions of the world.</p> <p>Overall Height: 6.73 (171) Overall OD: 2.17 (55) BPV Setting: 29.01 (200) End 1 ID: 1.02 (26)</p>	<p>ST2253 INTERNORMEN 1E12040G16EP This product is not available in all regions of the world.</p> <p>Overall Height: 6.61 (168) Overall OD: 2.17 (55) End 1 ID: 1.02 (26)</p>
<p>ST2237 EPPENSTEINER 11801H20SLA000P This product is not available in all regions of the world.</p> <p>Overall Height: 29.98 (762) Overall OD: 5.61 (143) End 1 ID: 3.62 (92)</p>	<p>ST2246 INTERNORMEN 1E12040G16SP This product is not available in all regions of the world.</p> <p>Overall Height: 6.73 (171) Overall OD: 2.17 (55) BPV Setting: 29.01 (200) End 1 ID: 1.02 (26)</p>	<p>ST2254 INTERNORMEN 1E12080G16EP This product is not available in all regions of the world.</p> <p>Overall Height: 6.61 (168) Overall OD: 2.17 (55) End 1 ID: 1.02 (26)</p>
<p>ST2238 EPPENSTEINER 1901P10A000P This product is not available in all regions of the world.</p> <p>Overall Height: 15.22 (387) Overall OD: 5.61 (143) End 1 ID: 3.62 (92)</p>	<p>ST2247 INTERNORMEN 1E12080G16SP This product is not available in all regions of the world.</p> <p>Overall Height: 6.73 (171) Overall OD: 2.17 (55) BPV Setting: 29.01 (200) End 1 ID: 1.02 (26)</p>	<p>ST2255 INTERNORMEN 1E1203VG16EP This product is not available in all regions of the world.</p> <p>Overall Height: 6.61 (168) Overall OD: 2.17 (55) End 1 ID: 1.02 (26)</p>
<p>ST2239 EPPENSTEINER 1561G25A000P This product is not available in all regions of the world.</p> <p>Overall Height: 10.37 (264) Overall OD: 5.61 (143) End 1 ID: 3.62 (92)</p>	<p>ST2248 INTERNORMEN 1E12010VG16SP This product is not available in all regions of the world.</p> <p>Overall Height: 6.73 (171) Overall OD: 2.17 (55) BPV Setting: 29.01 (200) End 1 ID: 1.02 (26)</p>	<p>ST2256 INTERNORMEN 1E1206VG16EP This product is not available in all regions of the world.</p> <p>Overall Height: 6.61 (168) Overall OD: 2.17 (55) End 1 ID: 1.02 (26)</p>
<p>ST2240 EPPENSTEINER 1561G40A000P This product is not available in all regions of the world.</p> <p>Overall Height: 10.37 (264) Overall OD: 5.61 (143) End 1 ID: 3.62 (92)</p>		<p>ST2257 INTERNORMEN 1E12010VG16EP This product is not available in all regions of the world.</p> <p>Overall Height: 6.61 (168) Overall OD: 2.17 (55) End 1 ID: 1.02 (26)</p>

























E. PRODUCT GUIDE

ST2258 INTERNORMEN 1E12025VG16EP This product is not available in all regions of the world. Overall Height: 6.61 (168) Overall OD: 2.17 (55) End 1 ID: 1.02 (26)	ST2267 MP FILTRI CU630A10N This product is not available in all regions of the world. Overall Height: 9.92 (252) Overall OD: 5.12 (130) End 1 ID: 2.90 (74)	TF15013 GMC 6437741, ALLISON 6437741  Height: 0.81 (21) Length: 11.73 (298) Width: 6.48 (165)
ST2259 INTERNORMEN 1E12010P16EP This product is not available in all regions of the world. Overall Height: 6.61 (168) Overall OD: 2.17 (55) End 1 ID: 1.02 (26)	ST2270 EPPENSTEINER 11400H6SLA000P This product is not available in all regions of the world. Overall Height: 20.24 (514) Overall OD: 5.59 (142) End 1 ID: 3.70 (94)	TF15016 FORD D3BZ7A098A  Height: 0.74 (19) Length: 7.09 (180) Width: 4.49 (114)
ST2260 INTERNORMEN 1E12025P16EP This product is not available in all regions of the world. Overall Height: 6.61 (168) Overall OD: 2.17 (55) End 1 ID: 1.02 (26)	ST2271 EPPENSTEINER 11400H10SLA000P This product is not available in all regions of the world. Overall Height: 20.24 (514) Overall OD: 5.59 (142) End 1 ID: 3.70 (94)	TF15018 CHRYSLER 4504048  Height: 1.24 (32) Length: 7.20 (183) Width: 6.89 (175)
ST2261 EPPENSTEINER 11401G25A000P This product is not available in all regions of the world. Overall Height: 20.20 (513) Overall OD: 5.61 (143) End 1 ID: 3.62 (92)	ST2272 EPPENSTEINER 11400H20SLA000P This product is not available in all regions of the world. Overall Height: 20.24 (514) Overall OD: 5.59 (142) End 1 ID: 3.70 (94)	TF15019 PUROLATOR P232  Height: 0.41 (10) Length: 7.12 (181) Width: 6.67 (169)
ST2262 EPPENSTEINER 232H20SLA000P, EPPENSTEINER 232P25A000P This product is not available in all regions of the world. Overall Height: 3.31 (84) Overall OD: 1.75 (45) End 1 ID: 0.61 (16)	Transmission Filters	
ST2263 INTERNORMEN 1E3206VG16SP This product is not available in all regions of the world. Overall Height: 12.17 (309) Overall OD: 2.76 (70) BPV Setting: 29.01 (200) End 1 ID: 1.61 (41)	TF15000 FORD E9TZ7A098A  Height: 4.50 (114) Length: 11.61 (295) Width: 7.03 (179)	TF15020 GMC 6439567  Height: 0.41 (10) Length: 7.12 (181) Width: 6.67 (169)
ST2264 EPPENSTEINER 232P25A000A This product is not available in all regions of the world. Overall Height: 3.31 (84) Overall OD: 1.75 (45) End 1 ID: 0.61 (16)	TF15001 FORD E9TZ7A098B  Height: 5.95 (151) Length: 11.61 (295) Width: 7.03 (179)	TF15021 GMC 8640848  Height: 0.56 (14) Length: 5.63 (143) Width: 5.47 (139)
ST2265 EPPENSTEINER 290P25A000P This product is not available in all regions of the world. Overall Height: 5.95 (151) Overall OD: 2.11 (54) End 1 ID: 0.92 (23)	TF15002 GMC 6839266  Height: 1.63 (41) Length: 12.75 (324) Width: 8.81 (224)	TF15023 FORD D5AZ7A098A  Height: 0.82 (21) Length: 7.32 (186) Width: 7.13 (181)
ST2266 EPPENSTEINER 2140P25A000P This product is not available in all regions of the world. Overall Height: 5.95 (151) Overall OD: 2.91 (74) End 1 ID: 1.56 (40)	TF15009 FORD D0DZ7A098B  Height: 0.72 (18) Length: 7.09 (180) Width: 4.41 (112)	TF15024 GMC 8657926  Height: 4.29 (109) Length: 7.95 (202) Width: 7.81 (198)
	TF15010 GMC 8675545  Height: 3.39 (86) Length: 8.53 (217) Width: 7.00 (178)	TF15025 ALLISON 6437741HD  Height: 0.79 (20) Length: 11.75 (298) Width: 6.47 (164)
	TF15011 FORD C6AZ7A098A  Height: 0.46 (12) Length: 9.23 (234) Width: 6.72 (171)	TF15026 ALLISON 6437741HD  Height: 0.79 (20) Length: 11.75 (298) Width: 6.47 (164)
	TF15012 FORD D0AZ7A098A  Height: 0.72 (18) Length: 6.55 (166) Width: 4.19 (106)	TF15027 FORD F4TZ7A098A  Height: 2.64 (67) Length: 9.55 (243) Width: 7.14 (181)
		TF15028 GMC 8660100  Height: 2.31 (59) Length: 10.83 (275) Width: 7.26 (184)
		TF15029 GMC 8851909  Height: 2.16 (55) Length: 10.60 (269) Width: 6.82 (173)























E. PRODUCT GUIDE

<p>TF15030 GMC 8662943</p>  <p>Height: 2.16 (55) Length: 10.60 (269) Width: 6.82 (173)</p>	<p>TF15051 NISSAN 3172841X01</p>  <p>Height: 2.56 (65) Length: 8.87 (225) Width: 6.51 (165)</p>	<p>TF15071 CHRYSLER 4799662</p> <p>Overall Height: 4.02 (102) Inlet Connection: 0 Outlet Connection: 0 Largest OD: 2.69 (68)</p>
<p>TF15031 GMC 8681082</p>  <p>Height: 3.94 (100) Length: 9.45 (240) Width: 7.52 (191)</p>	<p>TF15052 WIX 58937</p>  <p>Height: 0.89 (23) Length: 9.23 (234) Width: 7.06 (179)</p>	<p>TF15072 CHRYSLER 5013470AB</p>  <p>Height: 4.79 (122) Length: 12.07 (307) Width: 5.58 (142)</p>
<p>TF15032 FORD F4DZ7A098A</p>  <p>Height: 2.33 (59) Length: 7.08 (180) Width: 7.70 (196)</p>	<p>TF15053 GMC 24208847</p>  <p>Height: 3.65 (93) Length: 8.53 (217) Width: 7.00 (178)</p>	<p>TF15073 CHRYSLER 4800029AA</p>  <p>Height: 4.38 (111) Length: 12.07 (307) Width: 6.13 (156)</p>
<p>TF15033 FORD F2VY7A098A</p>  <p>Height: 1.65 (42) Length: 9.57 (243) Width: 7.13 (181)</p>	<p>TF15054 GMC 8634223</p>  <p>Height: 4.80 (122) Length: 9.58 (243) Width: 5.95 (151)</p>	<p>TF15074 MERCEDES-BENZ 1402770095 Panel Type with full flow capabilities and outside/in flow. Freightliner Sprinter Vans.</p>  <p>Height: 1.98 (50) Length: 7.36 (187) Width: 5.02 (128)</p>
<p>TF15034 CHRYSLER 4567070</p>  <p>Height: 1.36 (35) Length: 7.20 (183) Width: 6.89 (175)</p>	<p>TF15056 TOYOTA 3530314010</p>  <p>Height: 0.56 (14) Length: 4.90 (124) Width: 3.79 (96)</p>	<p>TF15075 MERCEDES-BENZ 2570467</p>  <p>Height: 5.09 (129) Length: 7.74 (197) Width: 5.54 (141)</p>
<p>TF15038 FORD E6TZ7A098B</p>  <p>Height: 0.81 (21) Length: 10.98 (279) Width: 4.29 (109)</p>	<p>TF15057 TOYOTA 3530330050</p>  <p>Height: 0.37 (9) Length: 5.16 (131) Width: 3.84 (98)</p>	<p>TF15076 GMC 3515996 Mexico only</p>  <p>Height: 0.60 (15) Length: 8.54 (217) Width: 6.54 (166)</p>
<p>TF15039 CHRYSLER 52118789</p>  <p>Height: 0.94 (24) Length: 7.19 (183) Width: 7.13 (181)</p>	<p>TF15058 AMERICAN MOTORS 8983504032</p>  <p>Height: 0.77 (20) Length: 5.17 (131) Width: 9.69 (246)</p>	<p>TF15077 FORD E9TZ7A098C Mexico only</p>  <p>Height: 0.60 (15) Length: 8.54 (217) Width: 6.54 (166)</p>
<p>TF15040 GMC 24208813</p>  <p>Height: 4.40 (112) Length: 9.65 (245) Width: 7.52 (191)</p>	<p>TF15059 NISSAN 31728X8600</p>  <p>Height: 0.60 (15) Length: 8.54 (217) Width: 6.54 (166)</p>	<p>TF15078 GMC 8651909 Mexico only</p>  <p>Height: 0.60 (15) Length: 8.54 (217) Width: 6.54 (166)</p>
<p>TF15041 FORD F1CZ7A098A</p>  <p>Height: 1.92 (49) Length: 5.21 (132) Width: 5.10 (130)</p>	<p>TF15062 GMC 747451</p>  <p>Height: 0.45 (11) Length: 6.88 (175) Width: 4.66 (118)</p>	<p>TF15082 ALLISON 29537966</p> <p>Height: 5.13 (130) Length: 9.48 (241) Width: 6.42 (163)</p>
<p>TF15042 MITSUBISHI MD6731100</p>  <p>Height: 0.92 (23) Length: 7.23 (184) Width: 5.10 (130)</p>	<p>TF15063 GMC 24208835</p>  <p>Height: 3.94 (100) Length: 9.65 (245) Width: 7.52 (191)</p>	<p>Water Filters</p>
<p>TF15046 NISSAN 3172880X03</p>  <p>Height: 1.16 (29) Length: 6.18 (157) Width: 5.69 (145)</p>	<p>TF15065 GMC 86985185</p>  <p>Height: 1.78 (45) Length: 8.20 (208) Width: 13.27 (337)</p>	<p>WF2015 MACK 25MF314A Mack Mid-liner 3/4 W/20 DCA4 8 units</p>  <p>Overall Height: 5.40 (137) Largest OD: 3.72 (94) Chemical Additive: DCA4+ Thread Size: 3/4-20 UNEF-2B</p>
<p>TF15047 FORD E6TZ7A098A</p>  <p>Height: 2.26 (57) Length: 10.98 (279) Width: 4.29 (109)</p>	<p>TF15067 TOYOTA 3533050010</p>  <p>Height: 1.23 (31) Length: 8.13 (207) Width: 6.30 (160)</p>	<p>WF2022 MACK 25MF422 Mack 25MF422 DCA4 - 11 Units</p>  <p>Overall Height: 5.70 (145) Largest OD: 4.24 (108) Chemical Additive: DCA4+ Thread Size: 1-16 UN-2B</p>
<p>TF15048 FORD 87GT7A098AA</p>  <p>Height: 1.18 (30) Length: 10.98 (279) Width: 4.29 (109)</p>	<p>TF15068 TOYOTA 3533030010</p>  <p>Height: 0.89 (23) Length: 8.35 (212) Width: 5.12 (130)</p>	
<p>TF15049 GMC 94844024</p>  <p>Height: 0.83 (21) Length: 7.89 (200) Width: 4.53 (115)</p>	<p>TF15070 TOYOTA 3530335010</p>  <p>Height: 0.65 (17) Length: 12.22 (310) Width: 3.94 (100)</p>	
<p>TF15050 TOYOTA 3533032030</p>  <p>Height: 0.82 (21) Length: 8.02 (204) Width: 5.03 (128)</p>		





E. PRODUCT GUIDE

<p>WF2051 Cummins 11/16 w/16 DCA2-4 units</p>  <p>Overall Height: 4.16 (106) Largest OD: 3.69 (94) Chemical Additive:DCA2 (MODIFIED) Thread Size: 11/16-16 UN-2B</p>	<p>WF2072 CUMMINS 3100305 Cummins 11/16 w/16 DCA4-6 units</p>  <p>Overall Height: 4.16 (106) Largest OD: 3.69 (94) Chemical Additive:DCA4+ Thread Size: 11/16-16 UN-2B</p>	<p>WF2083 Mack Mid-liner 3/4 w/20 DCA4-4 units</p>  <p>Overall Height: 5.40 (137) Largest OD: 3.72 (94) Chemical Additive:DCA4+ Thread Size: 3/4-20 UNF-2B</p>
<p>WF2053 INGERSOLL-RAND 35357276 Uses service part: 258859S Cummins 11/16 w/16 DCA2-8 units</p>  <p>Overall Height: 5.40 (137) Largest OD: 3.72 (94) Chemical Additive:DCA2 (MODIFIED) Thread Size: 11/16-16 UN-2B</p>	<p>WF2073 CUMMINS 4058964 Cummins 11/16 w/16 DCA4-8 units</p>  <p>Overall Height: 5.41 (137) Largest OD: 3.69 (94) Chemical Additive:DCA4+ Thread Size: 11/16-16 UN-2B</p>	<p>WF2084 FORD E8NN8A424BA, NEW HOLLAND E8NN8A424BA New Holland M20x1.5 DCA-0 units</p>  <p>Overall Height: 4.15 (105) Largest OD: 3.75 (95) Chemical Additive:NONE Thread Size: 11/16-16 UN-2B</p>
<p>WF2054 Cummins 11/16 w/16 DCA2-15 units</p>  <p>Overall Height: 5.40 (137) Largest OD: 3.72 (94) Chemical Additive:DCA2 (MODIFIED) Thread Size: 11/16-16 UN-2B</p>	<p>WF2074 CUMMINS 3100307 Cummins 11/16 w/16 DCA4-12 units</p>  <p>Overall Height: 5.41 (137) Largest OD: 3.69 (94) Chemical Additive:DCA4+ Thread Size: 11/16-16 UN-2B</p>	<p>WF2087 FORD E8NN8A424DA, FORD E8NN8A424CA New Holland 11/16 w/16 DCA2-9 units</p>  <p>Overall Height: 4.19 (106) Largest OD: 3.75 (95) Chemical Additive:DCA4+ Thread Size: 11/16-16 UN-2B</p>
<p>WF2054A Nylon spring at end plate area, shell and flange are thicker than the WF2054, and label imprint is different than the WF2054</p>  <p>Overall Height: 5.40 (137) Largest OD: 3.72 (94) Chemical Additive:DCA2 (MODIFIED) Thread Size: 11/16-16 UN-2B</p>	<p>WF2075 CUMMINS 3100308 Cummins 11/16 w/16 DCA4-15 units</p>  <p>Overall Height: 5.41 (137) Largest OD: 3.69 (94) Chemical Additive:DCA4+ Thread Size: 11/16-16 UN-2B</p>	<p>WF2088 KOMATSU 6004111191, CUMMINS 3864148 Komatsu 11/16 w/16 DCA2-6 units</p>  <p>Overall Height: 4.15 (105) Largest OD: 3.70 (94) Chemical Additive:DCA2 (MODIFIED) Thread Size: 11/16-16 UN-2B</p>
<p>WF2055 INGERSOLL-RAND 56985971 Cummins 11/16 w/16 DCA2-23 units</p>  <p>Overall Height: 7.53 (191) Largest OD: 3.72 (94) Chemical Additive:DCA2 (MODIFIED) Thread Size: 11/16-16 UN-2B</p>	<p>WF2076 CUMMINS 4058965 Uses service part: 3827107S Cummins 11/16 w/16 DCA4-23 units</p>  <p>Overall Height: 7.56 (192) Largest OD: 3.69 (94) Chemical Additive:DCA4+ Thread Size: 11/16-16 UN-2B</p>	<p>WF2091 KOMATSU 6004111171</p>  <p>Overall Height: 8.14 (207) Largest OD: 4.24 (108) Chemical Additive:DCA2 (MODIFIED) Thread Size: 11/16-16 UN-2B</p>
<p>WF2056 CATERPILLAR 1W5518 Cummins 11/16 w/16 DCA2-34 units</p>  <p>Overall Height: 10.47 (266) Largest OD: 4.24 (108) Chemical Additive:DCA2 (MODIFIED) Thread Size: 11/16-16 UN-2B</p>	<p>WF2077 CUMMINS 3827423 Cummins 11/16 w/16 DCA-0 units</p>  <p>Overall Height: 5.41 (137) Largest OD: 3.75 (95) Chemical Additive:NONE Thread Size: 11/16-16 UN-2B</p>	<p>WF2093 FORD E8NN8A424BB, NEW HOLLAND E8NN8A424BB New Holland 11/16 w/16 DCA4-5 units. Not available in all parts of the world.</p>  <p>Overall Height: 3.24 (82) Largest OD: 3.71 (94) Chemical Additive:DCA4+ Thread Size:11/16-16 UN-2B</p>
<p>WF2070 CUMMINS 3100303 Cummins 11/16 w/16 DCA4-2 units</p>  <p>Overall Height: 4.15 (105) Largest OD: 3.69 (94) Chemical Additive:DCA4+ Thread Size: 11/16-16 UN-2B</p>	<p>WF2078 Mack Mid-liner 3/4 w/20 DCA-0 units</p>  <p>Overall Height: 5.41 (137) Largest OD: 3.75 (95) Chemical Additive:NONE Thread Size: 3/4-20 UNF-2B</p>	<p>WF2096 VOLVO 1661964 Volvo M16 w/1.5 DCA2-4 units</p>  <p>Overall Height: 5.45 (138) Largest OD: 3.68 (93) Chemical Additive:DCA2 (MODIFIED) Thread Size: M16 X 1.5-6H INT</p>
<p>WF2071 CUMMINS 3100304 Cummins 11/16 w/16 DCA4-4 units</p>  <p>Overall Height: 4.15 (105) Largest OD: 3.69 (94) Chemical Additive:DCA4+ Thread Size: 11/16-16 UN-2B</p>	<p>WF2079 Mack ESI 1-16 UN2B DCA-) units</p>  <p>Overall Height: 5.70 (145) Largest OD: 4.24 (108) Thread Size: 1-16 UN-2B</p>	<p>WF2101 CASE 1820358C1, IHC 1820358C1 Int'l 11/16 w/16 DCA-0 units</p>  <p>Overall Height: 5.41 (137) Largest OD: 3.69 (94) Chemical Additive:NONE Thread Size: 11/16-16 UN-2B</p>











E. PRODUCT GUIDE

<p>WF2104 CASE 1820361C1, IHC 1820361C1 Int'l 11/16 w/16 DCA4-15 units</p>  <p>Overall Height: 5.41 (137) Largest OD: 3.69 (94) Chemical Additive:DCA4+ Thread Size: 11/16-16 UN-2B</p>	<p>WF2124 General Usage</p>  <p>Overall Height: 5.43 (138) Largest OD: 3.69 (94) Chemical Additive:DCA4+ Thread Size: 3/4-20 UNEF-2B</p>	<p>WF2134 Mack ES 3/4 w/20 DCA-0 units</p>  <p>Overall Height: 4.17 (106) Largest OD: 3.69 (94) Thread Size: 3/4-20 UNEF-2B</p>
<p>WF2106 INTERNATIONAL TRUCKS 1822313C1 Int'l 11/16 w/16 DCA4-4 units</p>  <p>Overall Height: 5.41 (137) Largest OD: 3.69 (94) Chemical Additive:DCA4+ Thread Size: 11/16-16 UN-2B</p>	<p>WF2126 INGERSOLL-RAND 54662051, CUMMINS 4907485 Uses service part: 3958392S Cum Sig M36x2.0 DCA4-8 units</p>  <p>Overall Height: 5.76 (146) Largest OD: 3.69 (94) Chemical Additive:DCA4+ Thread Size: M36 X 2-6G INT</p>	<p>WF2135 Mack ES 1-16 UN2B DCA- 0 units. Not available in all parts of the world.</p>  <p>Overall Height: 5.70 (145) Largest OD: 4.24 (108) Thread Size: 1-16 UN-2B</p>
<p>WF2107 INTERNATIONAL TRUCKS 1825314C1 Int'l 11/16 w/16 DCA-0 units</p>  <p>Overall Height: 4.15 (105) Largest OD: 3.69 (94) Chemical Additive:NONE Thread Size: 11/16-16 UN-2B</p>	<p>WF2127 CUMMINS 3680434 Uses service part: 3958392S Cummins Signature M36x2.0 ES DCA-0 units</p>  <p>Overall Height: 5.76 (146) Largest OD: 3.77 (96) Chemical Additive:NONE Thread Size: M36 X 2-6G INT</p>	<p>WF2137 Mack ES 1-16 UN2B DCA-0 units</p> <p>Overall Height: 5.69 (145) Largest OD: 4.24 (108) Thread Size: 1-16 UN-2B</p>
<p>WF2108 VOLVO 3945411 Volvo M16 w/1.5 DCA4+ - 8 units</p>  <p>Overall Height: 5.46 (139) Largest OD: 3.69 (94) Chemical Additive:DCA4+ Thread Size: M16 X 1.5-6H INT</p>	<p>WF2128 Volvo ES M16x1.5 DCA4+ coated tablets</p>  <p>Overall Height: 5.44 (138) Largest OD: 3.69 (94) Chemical Additive:DCA4+ Thread Size: M16 X 1.5-6H INT</p>	<p>WF2138 Volvo ES M16x1.5 DCA2+ coated tablets</p>  <p>Overall Height: 5.44 (138) Largest OD: 3.69 (94) Chemical Additive:DCA2+ Thread Size: M16 X 1.5-6H INT</p>
<p>WF2109 VOLVO 3969696 Volvo M16 w/1.5 DCA-0 units w/o element</p>  <p>Overall Height: 5.44 (138) Largest OD: 3.69 (94) Chemical Additive:NONE Thread Size: M16 X 1.5-6H INT</p>	<p>WF2129 Volvo ES M16x1.5 DCA-0 units</p>  <p>Overall Height: 4.17 (106) Largest OD: 3.69 (94) Chemical Additive:NONE Thread Size: M16 X 1.5-6H INT</p>	<p>WF2142 SCANIA 342988</p>  <p>Overall Height: 4.02 (102) Largest OD: 3.68 (94) Thread Size: 11/16-16 UN-2B</p>
<p>WF2121 CUMMINS 3098688</p>  <p>Overall Height: 5.44 (138) Largest OD: 3.69 (94) Chemical Additive:DCA4+ Thread Size: 11/16-16 UN-2B</p>	<p>WF2130 Volvo ES M16x1.5 DCA-0 units Severe</p>  <p>Overall Height: 5.43 (138) Largest OD: 3.69 (94) Chemical Additive:NONE Thread Size: M16 X 1.5-6H INT</p>	<p>WF2144 KOMATSU 6004111151 Komatsu 11/16 w/16 DCA2-12 units</p>  <p>Overall Height: 5.40 (137) Largest OD: 3.69 (94) Chemical Additive:DCA2 (MODIFIED) Thread Size: 11/16-16 UN-2B</p>
<p>WF2122 CUMMINS 3098689</p>  <p>Overall Height: 4.18 (106) Largest OD: 3.69 (94) Chemical Additive:NONE Thread Size: 11/16-16 UN-2B</p>	<p>WF2131 Cummins ES 11/16 w/16 DCA2+ coated tablets</p>  <p>Overall Height: 5.43 (138) Largest OD: 3.69 (94) Chemical Additive:DCA2+ Thread Size: 11/16-16 UN-2B</p>	<p>WF2145 KOMATSU 6004111161 Komatsu 11/16 w/16 DCA2-18 units</p>  <p>Overall Height: 7.48 (190) Largest OD: 3.72 (95) Chemical Additive:DCA2 (MODIFIED) Thread Size: 11/16-16 UN-2B</p>
<p>WF2123 CUMMINS 3098690</p>  <p>Overall Height: 5.44 (138) Largest OD: 3.69 (94) Chemical Additive:NONE Thread Size: 11/16-16 UN-2B</p>	<p>WF2133 Mack ES 3/4 w/20 DCA2+ coated tablets</p>  <p>Overall Height: 5.43 (138) Largest OD: 3.69 (94) Chemical Additive:DCA2+ Thread Size: 3/4-20 UNEF-2B</p>	<p>Winslow</p> <p>82040A WINSLOW 3473, WINSLOW CP937T</p> <p>Overall Height: 8.88 OD: 2.88 ID: 1.60 CP Length: 3.60</p>
		<p>82051A WINSLOW WEL7518B2, WINSLOW EL7518B</p>  <p>Overall Height: 18.50 OD: 7.25 ID: 2.70 CP Length: 4.00</p>

E. PRODUCT GUIDE

82101A	WINSLOW F1840T Overall Height: 18.00 OD: 4.00 ID: 1.60	82351A	WINSLOW CP1542T Overall Height: 15.62 OD: 3.75 ID: 1.60 CP Length: 2.25	82377D	WINSLOW 4P3631, WINSLOW W1645T Overall Height: 16.00 OD: 4.38 ID: 1.60
82240A	WINSLOW F635T Overall Height: 6.00 OD: 3.50 ID: 1.40	82361A	WINSLOW F1544T, WINSLOW SS1544T, WINSLOW 1544T Overall Height: 15.62 OD: 3.75 ID: 1.50	82390A	WINSLOW CP41648T CP41648T 82390A Overall Height: 16.12 OD: 4.75 ID: 1.70 CP Length: 3.50
82250A	WINSLOW CP738T CP738O Overall Height: 7.00 OD: 3.50 ID: 1.60 CP Length: 3.00	82362A	WINSLOW W1544T Overall Height: 15.62 OD: 3.75 ID: 1.60	82390B	WINSLOW 243094 Overall Height: 16.12 OD: 4.75 ID: 1.70 CP Length: 3.50
82250C	WINSLOW 701601488 Overall Height: 7.00 OD: 3.50 ID: 1.60 CP Length: 3.00	82370D	WINSLOW CP151645TO Overall Height: 16.00 OD: 4.38 ID: 1.80 CP Length: 1.50	82400A	WINSLOW CP681648T Overall Height: 16.12 OD: 4.75 ID: 1.70 CP Length: 6.75
82270A	WINSLOW F8350 Overall Height: 8.12 OD: 3.50 ID: 1.60	82371A	WINSLOW CS1645T, WINSLOW GS1645T, WINSLOW SS1645T Overall Height: 16.00 OD: 4.38 ID: 1.80	82421A	WINSLOW W1670T Overall Height: 15.16 OD: 6.75 ID: 1.70
82280A	WINSLOW CP931C Overall Height: 9.12 OD: 2.88 ID: 1.60 CP Length: 1.50	82372A	WINSLOW DCS1645T  Overall Height: 16.00 OD: 4.38 ID: 1.80 CP Length: 4.50	82450A	WINSLOW CP1865T, WINSLOW CP681645T Overall Height: 18.18 OD: 6.50 ID: 2.70 CP Length: 6.75
82300A	WINSLOW L1040C F1040C 82300A Overall Height: 10.00 OD: 4.00 ID: 1.60	82373A	WINSLOW DS1645T  Overall Height: 16.00 OD: 4.38 ID: 1.80 CP Length: 4.50	82460A	WINSLOW F1870T  Overall Height: 18.88 OD: 6.50 ID: 2.40
82302B	WINSLOW W1040CSS Overall Height: 10.00 OD: 4.00 ID: 1.60	82374A	WINSLOW EX1645T Overall Height: 16.00 OD: 4.38 ID: 1.80 CP Length: 16.00	82461A	WINSLOW CP1871T, WINSLOW CP1875T, WINSLOW CP451871T Overall Height: 18.88 OD: 6.50 ID: 2.40 CP Length: 4.50
82310C	WINSLOW A266515, WINSLOW 417000 CP1044O Overall Height: 9.88 OD: 4.00 ID: 1.60 CP Length: 4.50	82375A	WINSLOW F1645T, WINSLOW L1645T Overall Height: 16.00 OD: 4.38 ID: 1.60	82470C	WINSLOW CP1850T, WINSLOW CP51850T Overall Height: 18.50 OD: 6.50 ID: 3.10 CP Length: 5.00
82320A	WINSLOW 515023, WINSLOW 775130 CP1046O Overall Height: 9.88 OD: 4.00 ID: 1.60 CP Length: 1.50	82376A	WINSLOW LC1645T Overall Height: 16.00 OD: 4.38 ID: 1.60	82480U	WINSLOW 172607, WINSLOW A022067 CP1874TO Overall Height: 17.25 OD: 6.50 ID: 2.80 CP Length: 5.00
82340A	WINSLOW 1246838 Overall Height: 12.25 OD: 4.75 ID: 1.60 CP Length: 4.50	82377A	WINSLOW W1645TO  Overall Height: 16.00 OD: 4.38 ID: 1.60	82481A	WINSLOW EX1874T Overall Height: 17.25 OD: 6.50 ID: 2.80
82340B	WINSLOW CP1251O Overall Height: 12.25 OD: 4.75 ID: 1.60 CP Length: 4.50	82377C	WINSLOW W1645TSS Overall Height: 16.00 OD: 4.38 ID: 1.60		

E. PRODUCT GUIDE

<p>82482A WINSLOW F1874T, WINSLOW L1874T</p> <p>Overall Height: 17.25 OD: 6.50 ID: 2.80</p>	<p>82537B WINSLOW W2465TSS</p> <p>Overall Height: 24.50 OD: 6.50 ID: 3.20</p>	<p>82646A WINSLOW GS3265T</p> <p>Overall Height: 32.12 OD: 6.50 ID: 3.70</p>
<p>82484A WINSLOW W1874T</p>  <p>Overall Height: 17.25 OD: 6.50 ID: 2.80</p>	<p>82581A WINSLOW WC3031T</p> <p>Overall Height: 30.70 OD: 2.75 ID: 1.60 CP Length: 4.50</p>	<p>82647A WINSLOW LC3265T</p> <p>Overall Height: 32.12 OD: 6.50 ID: 3.70</p>
<p>82484B WINSLOW W1874TSS</p> <p>Overall Height: 17.25 OD: 6.50 ID: 2.80</p>	<p>82602A WINSLOW L3143T F3143T</p>  <p>Overall Height: 30.75 OD: 4.38 ID: 1.60</p>	<p>82648A WINSLOW W3265T</p> <p>Overall Height: 32.12 OD: 6.50 ID: 3.70</p>
<p>82490A WINSLOW F1950T, WINSLOW L1950T</p>  <p>Overall Height: 18.88 OD: 4.75 ID: 1.60</p>	<p>82603A WINSLOW GS3143TO</p>  <p>Overall Height: 30.75 OD: 4.38 ID: 1.60</p>	<p>82651A WINSLOW F3643, WINSLOW G3643, WINSLOW L3643</p>  <p>OD: 4.38 ID: 1.60</p>
<p>82492A WINSLOW F1950T, WINSLOW L1950T</p>  <p>Overall Height: 18.50 OD: 4.75 ID: 1.60</p>	<p>82604A WINSLOW LC3143T</p> <p>Overall Height: 30.75 OD: 4.38 ID: 1.60</p>	<p>82652A WINSLOW W3643</p>  <p>82652A Overall Height: 36.12 OD: 4.38 ID: 1.60</p>
<p>82530A WINSLOW CP42465TO</p> <p>Overall Height: 24.75 OD: 6.50 ID: 3.20 CP Length: 4.00</p>	<p>82605A WINSLOW W3143T</p> <p>Overall Height: 30.75 OD: 4.38 ID: 1.60</p>	<p>82653A WINSLOW LC3643</p> <p>Overall Height: 36.12 OD: 4.38 ID: 1.60</p>
<p>82531A WINSLOW CP82465TO</p> <p>Overall Height: 24.75 OD: 6.50 ID: 3.20 CP Length: 8.00</p>	<p>82605C WINSLOW CT104518</p> <p>Overall Height: 30.75 OD: 4.38 ID: 1.60</p>	<p>82654A WINSLOW GS3643</p> <p>Overall Height: 36.12 OD: 4.38 ID: 1.60</p>
<p>82531B WINSLOW 120455100</p> <p>Overall Height: 24.75 OD: 6.50 ID: 3.20 CP Length: 8.00</p>	<p>82620D Winslow CP3245TO</p> <p>Overall Height: 31.25 OD: 4.38 ID: 1.60 CP Length: 4.00</p>	<p>82739A WINSLOW CP71543TO CP1543T</p> <p>Overall Height: 15.62 OD: 3.75 ID: 1.60 CP Length: 7.62</p>
<p>82532A WINSLOW WE55 CP152465TO</p>  <p>Overall Height: 24.75 OD: 6.50 ID: 3.20 CP Length: 15.00</p>	<p>82621A WINSLOW GS3245T</p> <p>Overall Height: 31.25 OD: 4.38 ID: 1.60</p>	<p>871547A WINSLOW W1065T</p> <p>Overall Height: 10.16 OD: 6.75 ID: 1.70</p>
<p>82533A WINSLOW EX2465T, WINSLOW WE65</p> <p>Overall Height: 24.75 OD: 6.50 ID: 3.20</p>	<p>82630A WINSLOW CP3621T</p> <p>Overall Height: 31.50 OD: 5.75 ID: 2.30 CP Length: 8.00</p>	<p>88365A WINSLOW F2465T, WINSLOW L2465TO</p>  <p>Overall Height: 24.75 OD: 6.50 ID: 3.70</p>
<p>82534A WINSLOW F2465T, WINSLOW L2465T</p>  <p>Overall Height: 24.75 OD: 6.50 ID: 3.20</p>	<p>82640A WINSLOW CP43265T</p>  <p>Overall Height: 32.12 OD: 6.50 ID: 3.70 CP Length: 4.00</p>	
<p>82536A WINSLOW LC2465T</p> <p>Overall Height: 24.75 OD: 6.50 ID: 3.20</p>	<p>82644A WINSLOW EX3265T</p> <p>Overall Height: 32.12 OD: 6.50 ID: 3.70 CP Length: 32.00</p>	
<p>82537A WINSLOW W2465T</p> <p>Overall Height: 24.50 OD: 6.50 ID: 3.20</p>	<p>82645A WINSLOW L3265T F3265T</p> <p>Overall Height: 32.12 OD: 6.50 ID: 3.70</p>	